

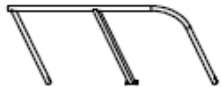









# NOR-FEI1058-SO ASSEMBLY INSTRUCTIONS

## Part list

Part no.	Drawing	Description	Qty.
A		Handle	1
B		Enclosure pole	2
C		Base	1
D		Wheel with brake	4
E		Bolt	12
F		Nut	12
G		Belt	1
H		Nut	16
I		Steel washer	32
J		Bolt	16
K		Spanner	2
L		Allen wrench	1

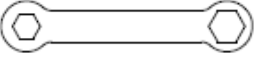
Step 1: Put 4 washers on 4 bolts, place a wheel under base corner, thread screw/washer through 4 holes and secure with washer/nut from the top with the wrench provided.

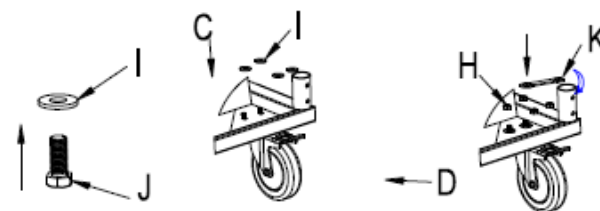

Repeat with remaining 3 wheels for base.

Step 2: Identify front from back (see description below)  
Set Enclosure Poles into place and secure with 12 bolts (E). Slide Handle into Enclosure Poles.

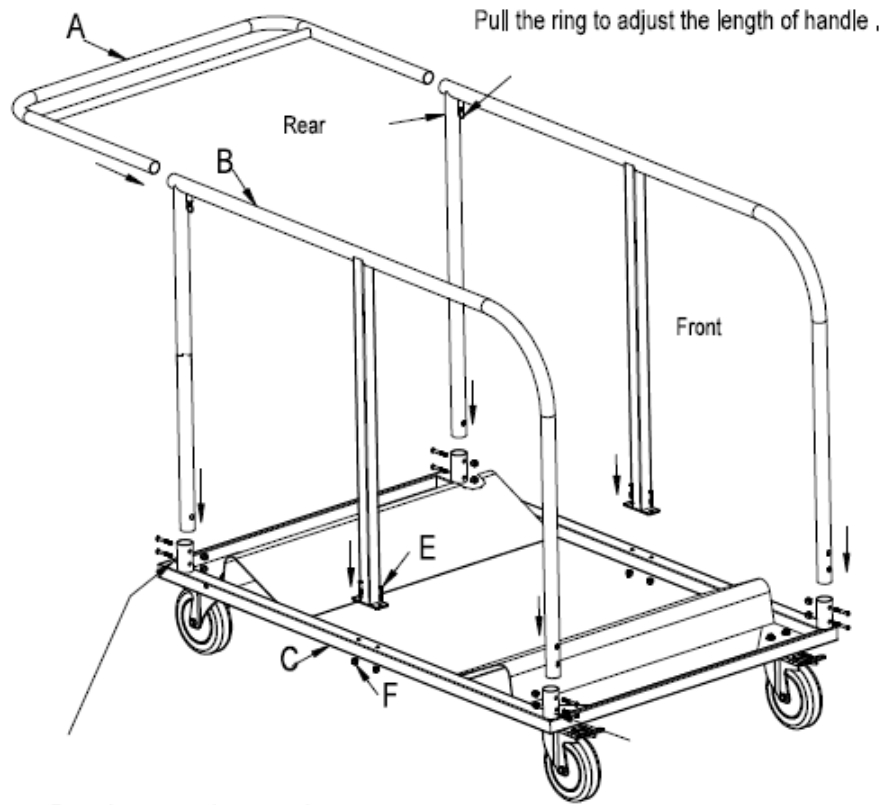

Rear , has space between the edge of the base and pole .

Front , has no space between the edge of the base and pole .

Use Belt to secure tables in trolley when not full.

