

Owner Manual

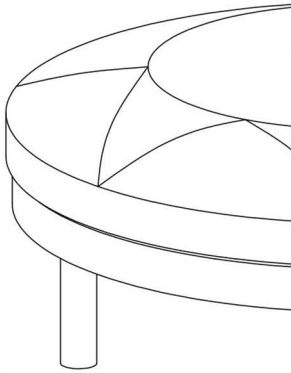

WARRANTY

We strive to offer high quality product and we also try our best to satisfy each customer that order from us, no matter on products or services as needed. Each customer receives a record of their order, such as the order number or item receipt. For any items that are out of warranty period, you may still be able to purchase the replacement parts from our company if they are available.



MAINTENANCE AND WARNING

Please read the manual thoroughly
before you start installing.

Please keep the product away from
sharp object.

Packaging and small parts may have
chocking hazard, please keep them away
from children and pets.

Please clean the product according to each
clean code, check the product description
for more information.

Please keep the product away
from fire.

If you have any other questions, please
contact us, we will be glad to help you out.

If the product is placed under direct
sunlight, the pattern or color might fade
away overtime.

Check the product periodically to make
sure everything is secured and tightened.

Always use proper tools for installation.

Do not jump on the product.



PRODUCT DESCRIPTION



Sleek armless design, the smooth, rounded shape enhances a minimalist yet inviting aesthetic.

Solid wood frame for durability and strength, built to withstand daily use without sacrificing style.

Wooden legs complete the modern aesthetic, offering both a sleek look and reliable stability.

Soft, premium leather top for a smooth, comfortable touch, making it ideal for casual lounging or stylish seating.

Well-padded cushion ensures excellent support, ideal for resting your feet or as extra seating.

EXPLODED VIEW

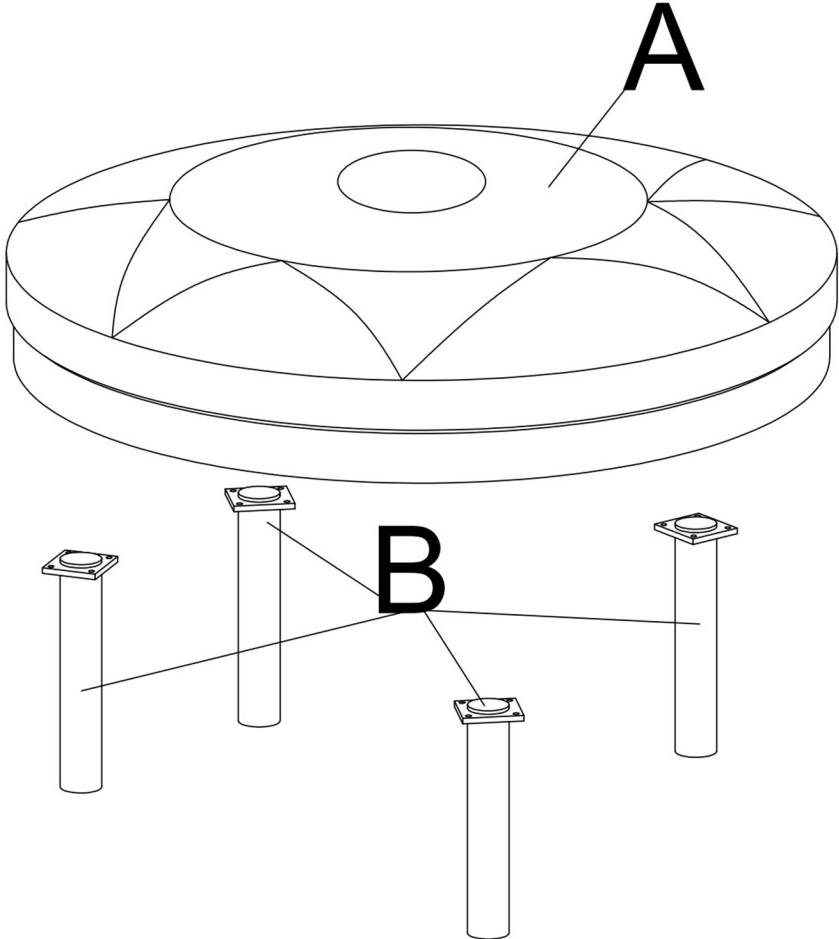

PARTS

A*1

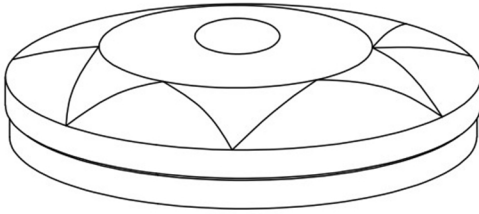

Seat frame

B*4



Legs

HARDWARE

TOOL LIST

NOTE: Designated with (★) We provide additional spare parts in the hardware package

①*16



★ Bolt

②*1

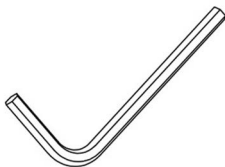

Allen key

Please make sure all hardware & packing material fitting the list. Especially some small accessories may be missing during transportation. Please contact us if you have any question.

step 1

Take out all the parts and place them on the ground as shown.

AX1

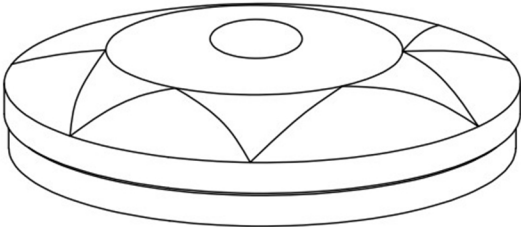

BX4

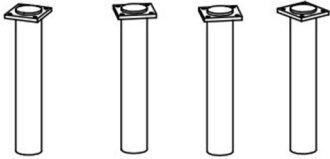

step 2

Place the Seat frame (A) on a clean surface, then align the wooden legs (B) to the predrilled holes on the edge of the frame as shown. Use the allen wrench (2) provided to tighten all the bolts (1) by 30-50% first, make sure the bolt holes on both legs and frame are correctly aligned before fully tightening.

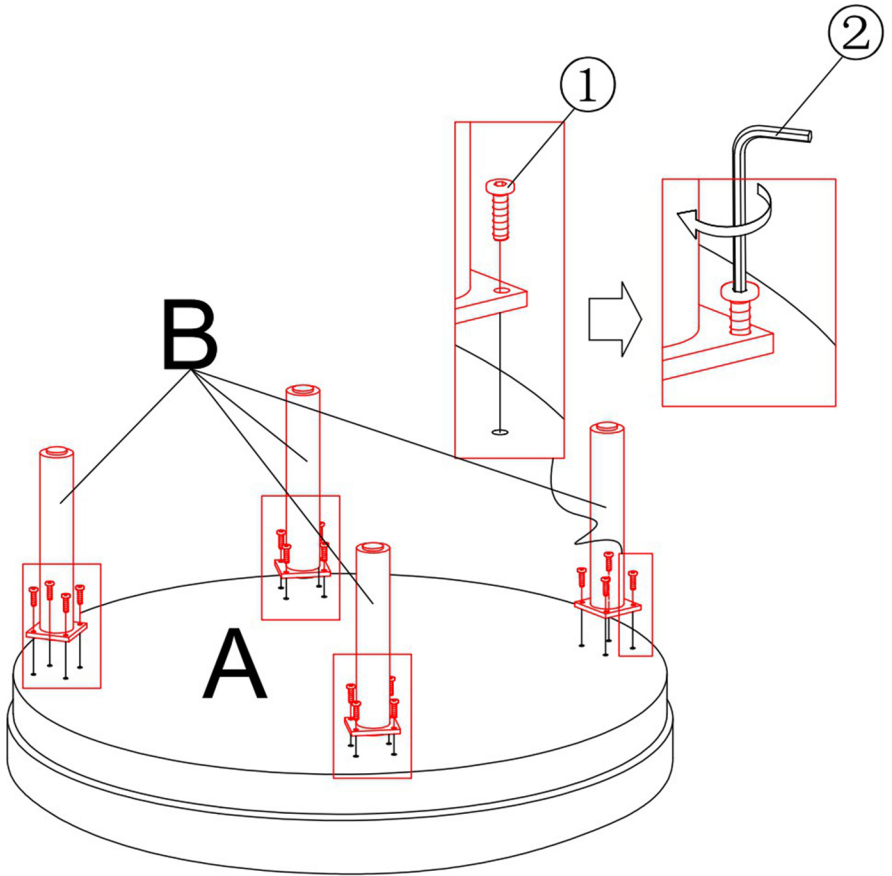

step 3

Congradulations! You have finished the assembly, thank you again for choosing our product! Please enjoy!

