

P1 Cabinet

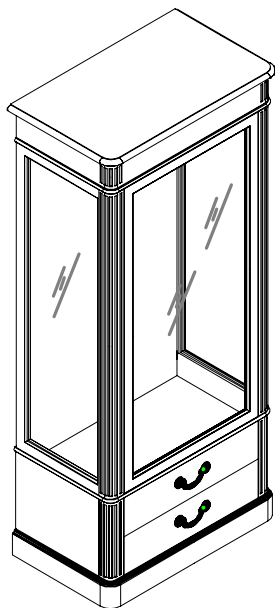

x 1

INSTRUCTION

1. If necessary, adjust glider on the legs of the base cabinet for levelling **refer detail 'A'**.
 2. Plug the power cord to the adapter and outlet on the wall then test the lights by touch on the Push switch of the top- right cabinet. **refer detail B,C.**
- // if the light dose not work, please double-check power cord, outlet or reverse the power cord conection (C1).**

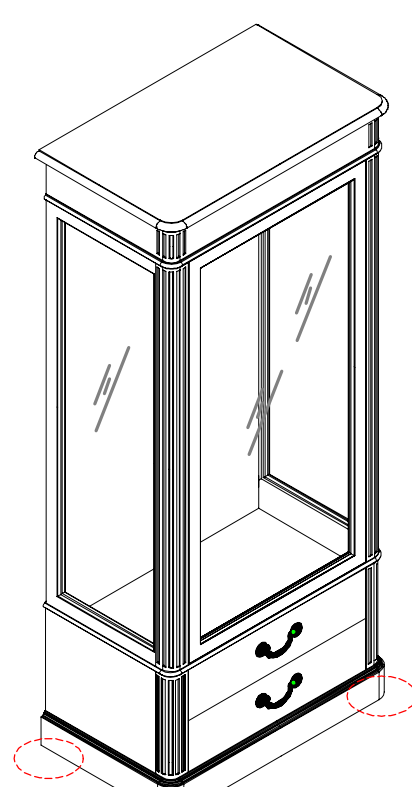

Adjustable glider
Detail 'A'

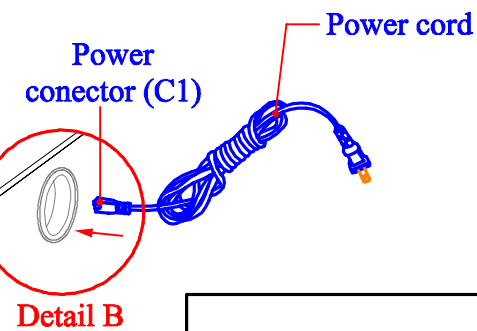
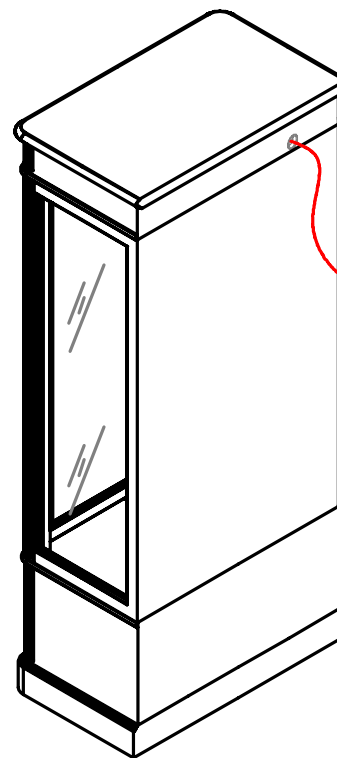

P2 Glass shelf

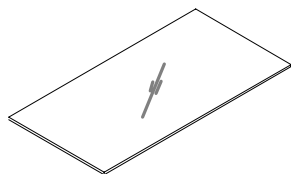

x 3

1 Brass shelf holder

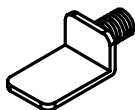

x 12

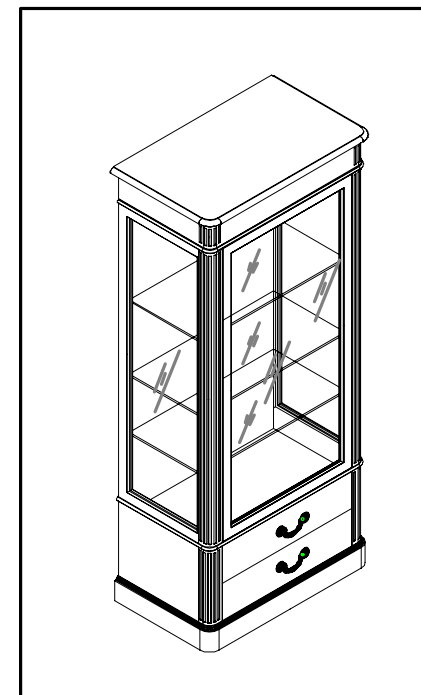

AL61108 ASSEMBLY INSTRUCTION

