

# INSTRUCTION MANUAL

## Luxury Health Massage Chair

### FCC Warning Statement

Changes or modifications not expressly approved by the party responsible for compliance could void the user's authority to operate the equipment. This equipment has been tested and found to comply with the limits for a Class B digital device, pursuant to Part 15 of the FCC Rules. These limits are designed to provide reasonable protection against harmful interference in a residential installation. This equipment generates uses and can radiate radio frequency energy and, if not installed and used in accordance with the instructions, may cause harmful interference to radio communications. However, there is no guarantee that interference will not occur in a particular installation. If this equipment does cause harmful interference to radio or television reception, which can be determined by turning the equipment off and on, the user is encouraged to try to correct the interference by one or more of the following measures:

- Reorient or relocate the receiving antenna.
- Increase the separation between the equipment and receiver.
- Connect the equipment into an outlet on a circuit different from that to which the receiver is connected.
- Consult the dealer or an experienced radio/TV technician for help.

This device complies with part 15 of the FCC Rules. Operation is subject to the following two conditions: (1) This device may not cause harmful interference, and (2) this device must accept any interference received, including interference that may cause undesired operation.

The device has been evaluated to meet general RF exposure requirement.

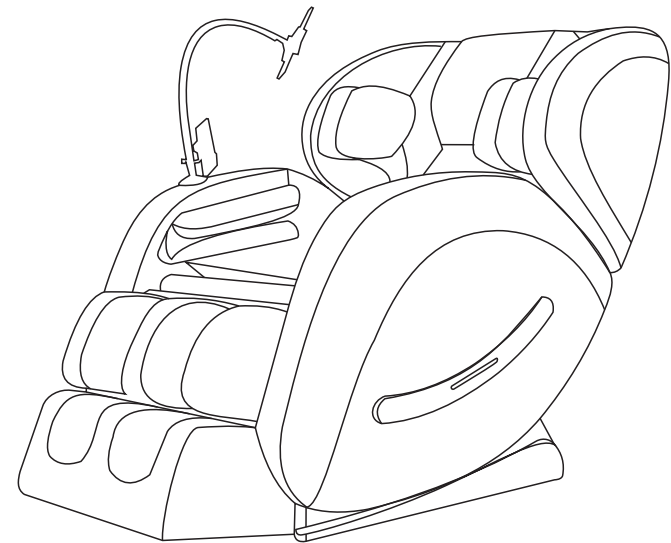

BE SURE TO READ THIS **INSTRUCTION MANUAL** CAREFULLY AND USE IT PROPERLY.  
AFTER USE, KEEP THIS MANUAL WITHIN REACH AT ALL TIME FOR FUTURE USE.

## IMPORTANT SAFETY INSTRUCTIONS

### OPERATING SURROUNDINGS

- Do not use or store the massage chair under damp environment: i.e. bathroom, sauna, spa to avoid any moldy, electric shock, fire or mechanical failure.
- Don't use the massage chair outdoors.
- Don't use the massage chair under dusty, smelly and anoxic conditions.
- Don't place the massage chair near heater, stove or sunlight radiation to avoid inner components overheating to cause fire.
- Make sure to place the massage chair on a flat level ground.
- The bracket part should be placed on the plain ground.
- To avoid an electric shock, please make sure to connect an earth wire.
- Don't use the machine while smoking.



### FOLLOWING CONDITIONS SHOULD CONSULT DOCTORS BEFORE USE

- Suffered from malignant tumor.
- Serious heart disease.
- Serious skin disease.
- Serious boned hyperplasia.
- In pregnancy or during the menses.
- Be on the rest cure under the doctor's supervision.
- The back bended exceptionally by the accident or disease.
- Needing peaceful surroundings.
- Arthritis disease.
- Implanted pacemaker for medical purpose.
- Suffered from bowels disease (i.e. gastritis, enteritis, diarrhea, hepatitis).
- Serious blood circulation trouble.
- Consciousness trouble.
- Be in hyper pyretic.

### WARNING

Children under 18 ages or special persons( as psychopath, the mental defects, the paralysis) are not allowed to operate the massage chair, in case of electric shock, injuries or mechanism malfunctions.

## IMPORTANT SAFETY INSTRUCTIONS

For safety reasons and in order to clearly indicate potential dangers should the product be used improperly, instructions have been marked in the following manners and should be strictly noted.

### CAUTIONS

**Non-professional technicians are not allowed to dismantle or repair to avoid fire, electrical shock or serious hurt.**



**Do not flush to the switch when cleaning to avoid insulation fault, electrical shock or short-circuit.**



**When storing or maintenance, be sure to disconnect the power plug from socket.**



Do not detach the plug by wet hands.

**Make sure to shut off and detach the power plug when cleaning or storing product.**



During cleaning or moving the machine, make sure to detach power cord to avoid fire or electrical shock.

**Do not place the machine onto an unstable surface to avoid roast, insulation failure, electrical shock or turnover.**



When storing the machine, make sure to disconnect power plug to avoid fire caused by electricity leaking.

**Clean power plug periodically to avoid fire due to dust.**



**Do not use it at any unsafe places or on other purposes.**  
It is the main reason of product damage or accident.



**Do not store the machine onto an unstable surface.**  
Unexpected earthquake or external force will cause damage or injury.



**Keep supply cord unobstructed at all time, i.e. not twisted, knotted, over flexed or pulled and do not place anything heavy on it.**



**The appliance has a heated surface. Persons insensitive to heat must be careful when using the appliance.**



## IMPORTANT SAFETY INSTRUCTIONS

### ⊘ CAUTIONS

**Do not modify the structure or change components by unauthorized person.**

Do not dismantle the machine by unauthorized person to avoid electrical shock, short-circuit or fire.



**Do not store it near a fire or flammable substances.**

It is one of the reasons of causing product torture, deviation or damage.



**Should any abnormality occur (i.e. scorching smell), stop using immediately and detach power plug from socket.**

Keeping operating under an abnormal situation will cause fire or electrical shock, please contact your local seller or authorized service agent for maintenance.



**Do not place the machine onto an unstable surface to avoid roast, insulation failure, electrical shock or turnover.**



**Only rated voltage must be used.**



**Stop using immediately if supply cord or power plug be damaged or loosen.**



**Be sure to keep children away during operating to avoid any hazard.**



**Do not explore it under sunshine at all time.**



**If the supply cord is damaged, it must be replaced by the manufacturer or its authorized persons for repair or maintenance to avoid any hazard.**



## INSTALLATION STEPS

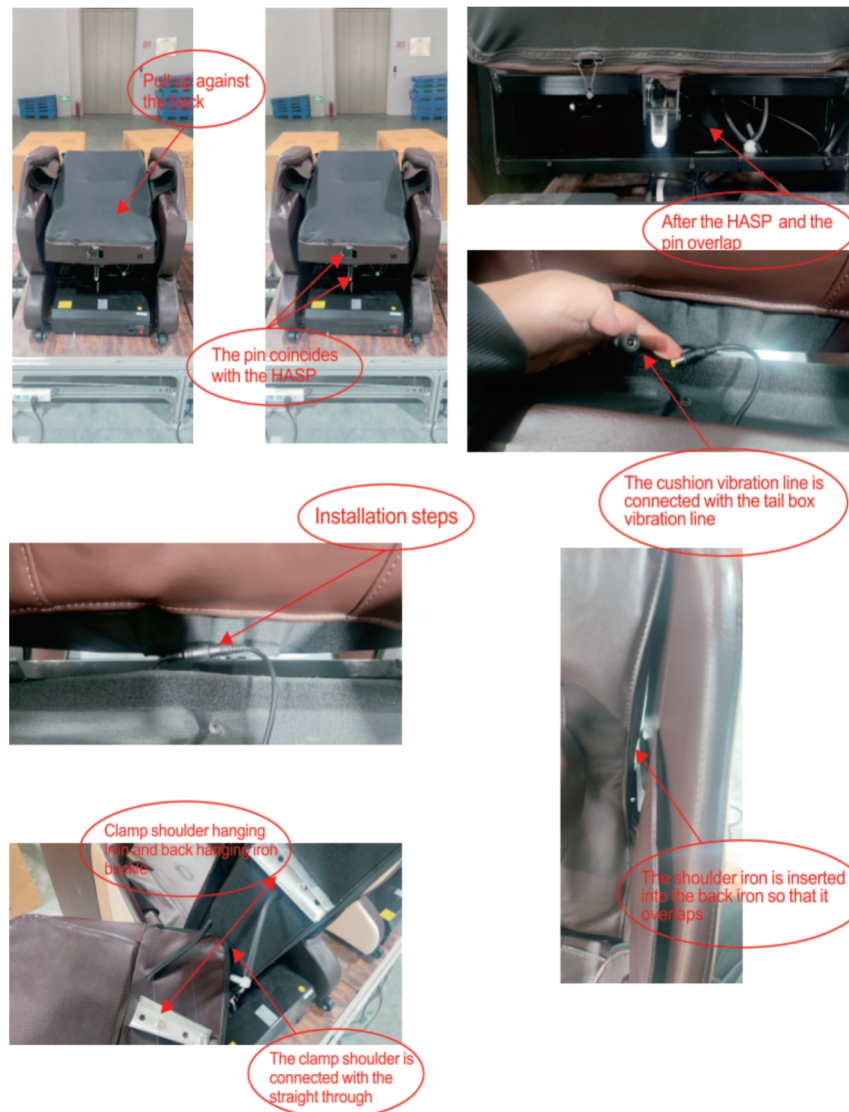



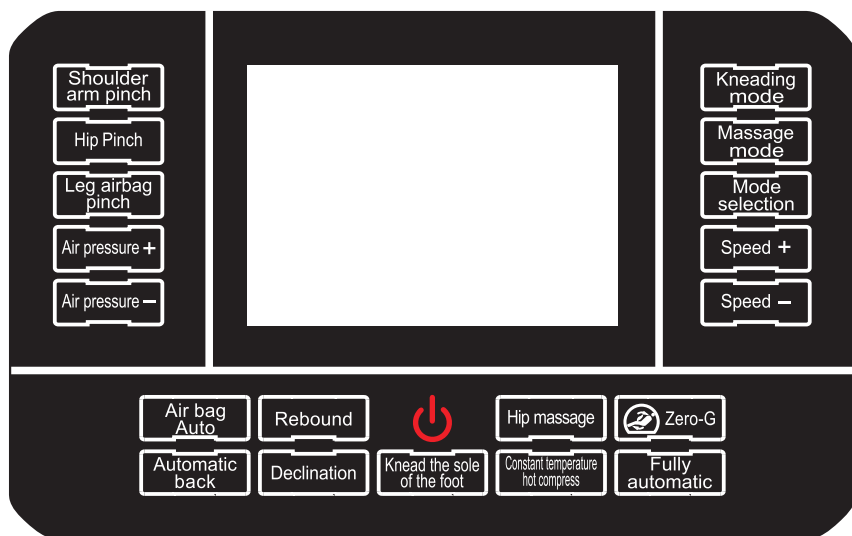

















## HAND CONTROLLER OPERATION INSTRUCTIONS



## SPECIFICATION

Product Name	Massage Chair
Product Model	
Rated Voltage	110~220V 50Hz
Rated Power	90W
Rated Working Time	15min
Security Level	Class I
Implementation Standards	GB4706.1-2005 GB4706.10-2008

## MASSAGE PROCEDURE INSTRUCTIONS

-  **Press one time start/Timing/Long press to shut down**  
**Press one time start:**When the power is on, press this button and the massage chair enters the automatic mode. The default working time is 15 minutes.  
**Timing:**When the massage chair is working, press this button, the massage chair enters the timed mode, and each time is increased by 5 minutes.  
**Long press to shut down:**When the massage chair is working, press and hold this button until the display screen is turned off.
- At the end of working hours, the massage chair will maintain its working posture. If you need to reset it to the original posture, please press the power button again.**
-  **Fully automatic:** press this key to set five modes, and select F1 / F2 / F3 / F4 / F5.
-  **Zero gravity:** press this key to recline / reset the massage chair.
-  **Hip massage:** press this key to turn on / off the cushion massage function.
-  **Constant temperature hot compress:** press this key to turn on / off the constant temperature hot compress function of calf and waist.
-  **Press this key to turn on the function / the scraping speed on the screen will display 2 gears by default. Each time you press it, it will increase by one gear. If you press the third gear again, it will turn off the function and turn it on again, and so on.**
-  **Pick up:** long press this key to adjust the reset and pick up function of massage chair (long press is effective).
-  **Recline:** long press this key to adjust the recline function of massage chair (long press is effective).
-  **Automatic airbag:** press this key to turn on / off the whole body airbag squeeze massage.
-  **Back automatic:** press this key to turn back movement massage on / off.
-  **Shoulder arm pinch:** press this key to turn on / off shoulder arm airbag pinch massage.
-  **Hip pinch:**Press this key to turn on /off hip airbag clamping Massage
-  **Leg airbag pinch:** press this key to turn on / off leg airbag pinch massage.
-  **Air pressure +:** the air bag extrusion force increases.
-  **Air pressure -:** the pressure of the air bag is reduced.
-  **Kneading mode:** press this key to turn on / off neck kneading massage.
-  **Massage mode:** press this key to turn on / off waist massage.
-  **Mode selection:** press this key to select the direction of the massage movement (positive / negative).
-  **Speed +:** the speed of the massage movement increases.
-  **Speed -:** the speed of the massage movement slows down.

## Bluetooth connection instructions:

- ① Turn on the Bluetooth voice prompt by default.
- ② Turn on the bluetooth function of mobile phone to search for BluetoothFind native Bluetooth code. Turn on the music and start playing when the connection is successful.

### Reminder:

Constant temperature hot compress and hip massage need to be turned on or off manually. Automatic mode does not enable these two functions.

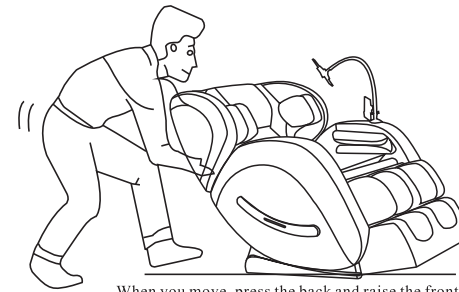

### Attention

- ① Please check and confirm if the power cord has been pressed under the massage chair.
- ② Whether the ground line is connected well
- ③ Before inserting the plug, make sure that all the operation buttons, including the power switch, are turned off.

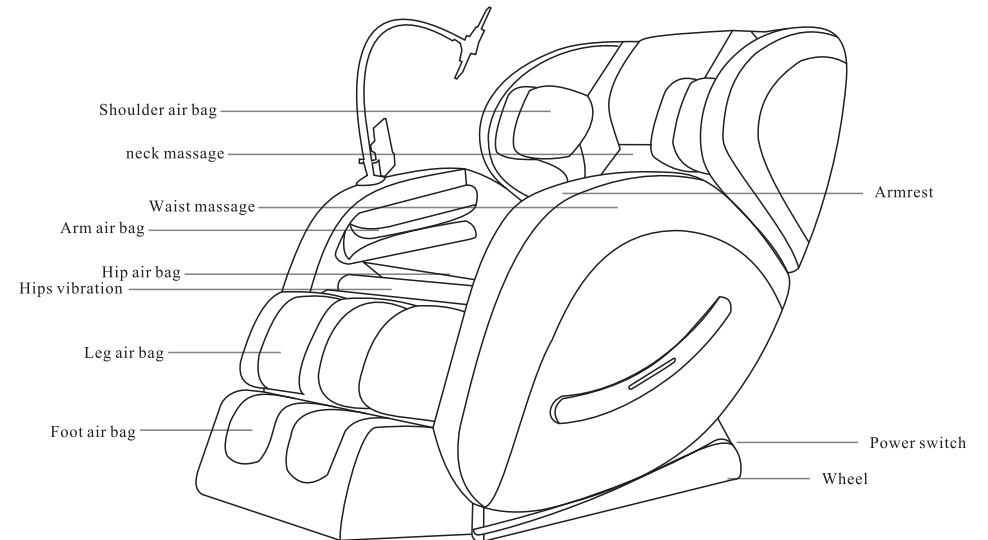
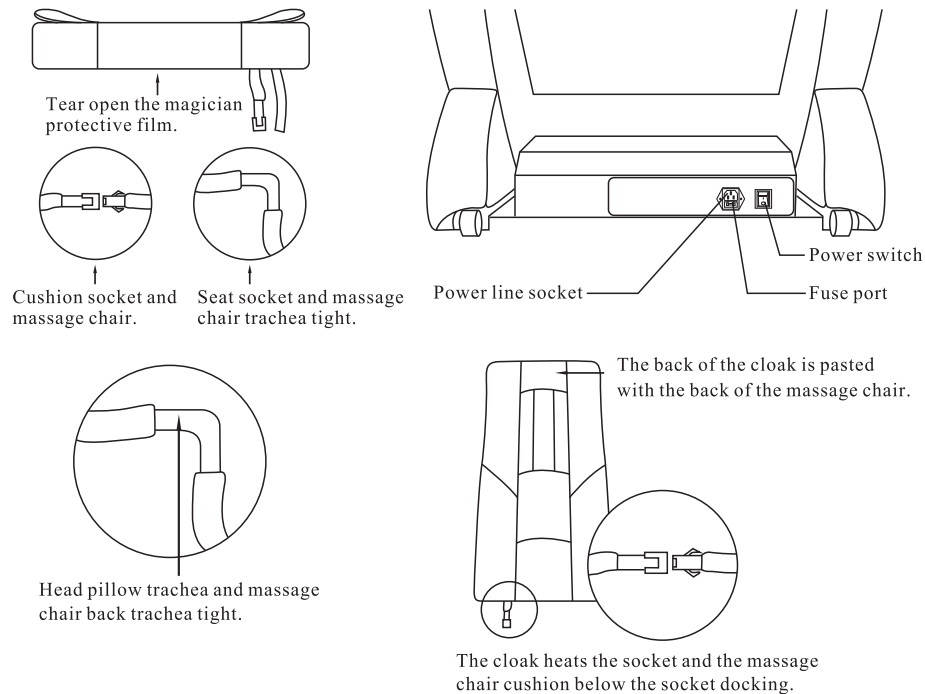

## SAFETY INSTRUCTIONS

1. Should any abnormality occur, shut off and detach power plug from socket.
2. When power cord damaged, it must be changed from special power cord or available from other manufacturer or service department.

**⚠ Warning:** Do not dismantle, modify or change components by unauthorized person to avoid electric shock or fire.

## DAILY CARE AND MAINTENANCE

### Storage guide

- ⦿ Do not dismantle back of chair. The electrical shock may happen to touch inner elements of chair.
- ⦿ Do not dismantle the machine by unauthorized person to avoid electric shock or fire.
- ⦿ Make sure to shut off and detach the power plug when cleaning to avoid electric shock or hazard.
- ⦿ Keep the massage chair clean and free dust. Do not place the massage chair under damp environment.
- ⦿ If not in use for a long period, please cover it with a cloth to free dust.
- ⦿ Do not place the massage chair under sunlight.

### Maintenance

- ⦿ Use neutral detergent only.
- ⦿ Use neutral detergent to clean back cushion, head cushion and leg cushion. Let it dry.
- ⦿ Use detergent and cloth to clean the plastic, pipe and leather material of massage chair.
- ⦿ Make sure not to use organic solvents as gasoline, amyl acetate, benzene for cleaning to avoid leather color fades, aging or broken.
- ⦿ Do not spray pesticide to avoid electric shock or fire.
- ⦿ Please clean with dry cloth to avoid mechanical failure.

### Controller maintenance

- ⦿ Do not place the massage chair near heater or fire.
- ⦿ Keep away from damp to avoid electric shock.
- ⦿ Please clean dust with soft cloth or small banister brush.
- ⦿ Make sure not to use volatile detergent as benzene, gasoline, amyl acetate.

## TROUBLE SHOOTING

Checking is necessary in frequent usage.

Make sure the machine work normally before usage.

Abnormality situation	Solution guide
Failure to start and indicator light off	<ul style="list-style-type: none"> <li>⦿ Check the plug is well connected</li> <li>⦿ Check the switch on the chair is turned to "I" position</li> </ul>
Sound in operation	<p><b>The sound is normal in following situation</b></p> <ul style="list-style-type: none"> <li>⦿ Sound for kneading or knocking</li> <li>⦿ Sound changes after speed adjustment</li> <li>⦿ Sound from box in massage</li> <li>⦿ Vibration sound for backrest in massage</li> <li>⦿ Sound for air input and output</li> <li>⦿ Sound for airbag inflating and venting</li> <li>⦿ Sound for leg adjustment</li> <li>⦿ Sound for motor when the massage chair is loaded</li> </ul>

## INSTALLATION STEPS OF REMOTE CONTROL BRACKET:

Step 1: insert the screw rod into the hole

Step 2: install the remote control on the bracket

Step 3: Open the plastic buckle on the back of the controller to adjust the height of the controller bracket

