

Top View

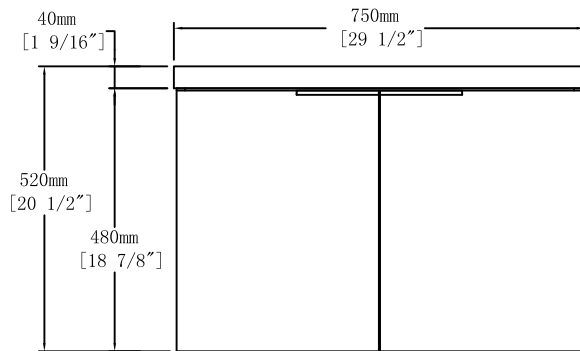

Front View

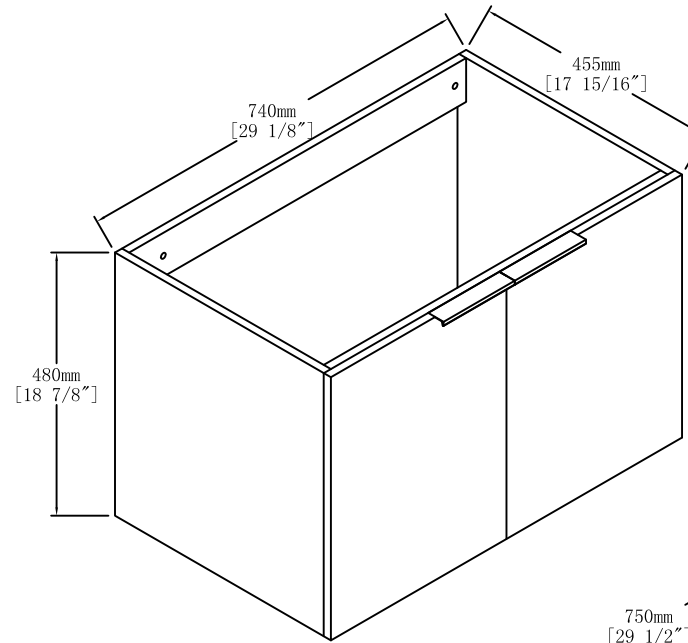
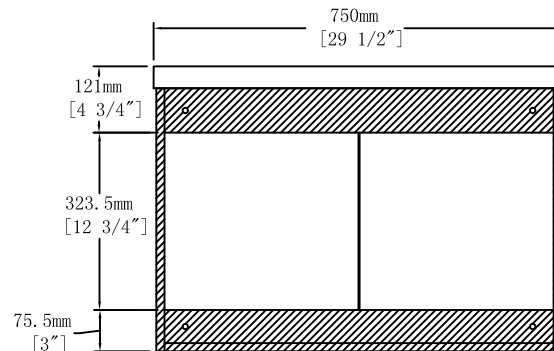

Back View

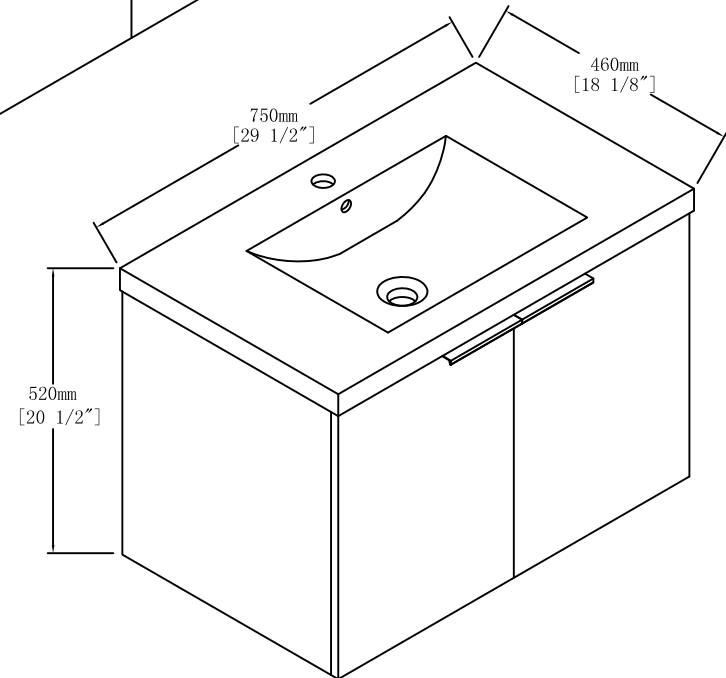

Item NO.

BV B09030

Version

V1

Project

Date

2024-2-20