

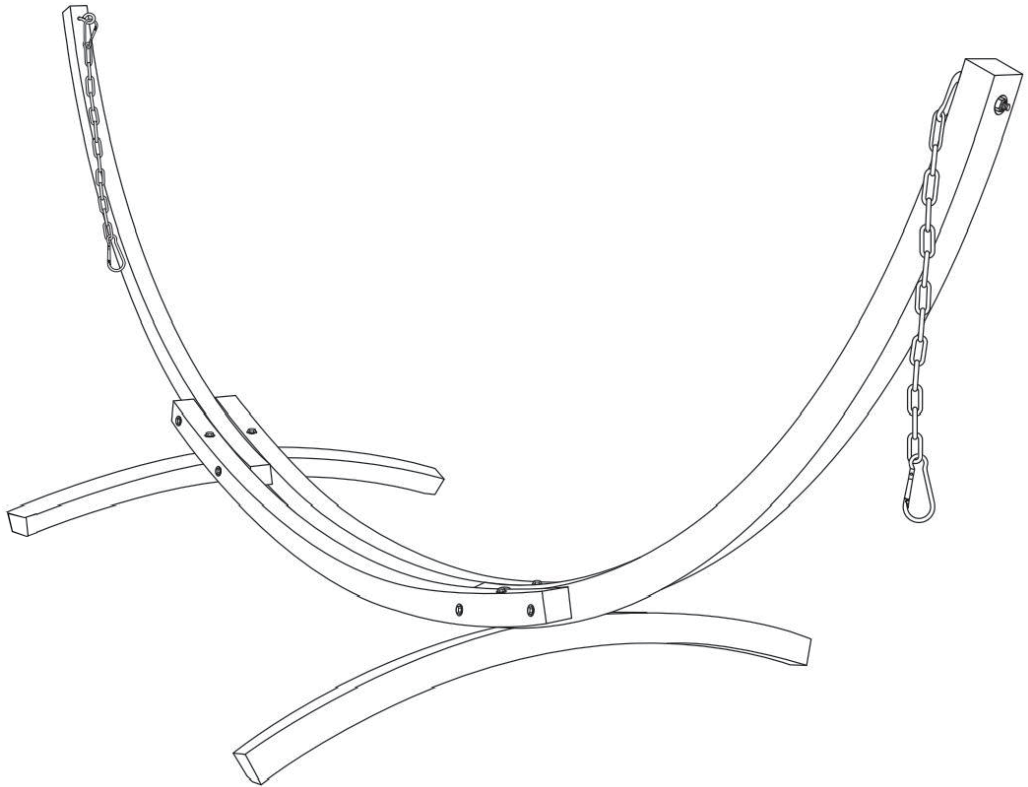









Wooden Hammock Stand



List of Accessories

 Short Screw ① × 4	 Long Screw ② × 4	 Eye Screw ③ × 2	 Nut ④ × 10	 Washer ⑤ × 14
 Metal Round Bar ⑥ × 2	 Hex Socket ⑦ × 2	 Hook ⑧ × 4	 Screw Protection Cover ⑨ × 10	 Chain ⑩ × 2

Assembly Parts

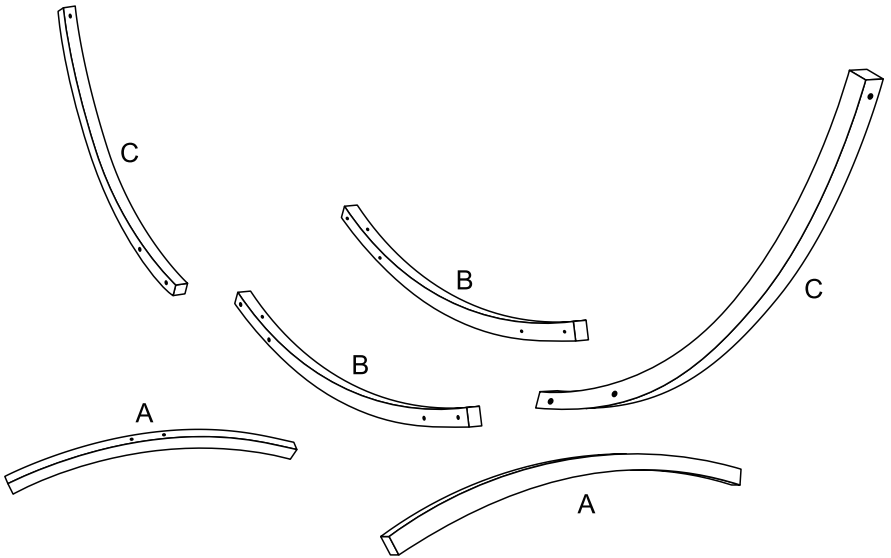

NO.	PARTS	QTY	NO.	PARTS	QTY
A	Foot Bracket A	×2	C	Side Pole C	×2
B	Foot Bracket B	×2			

Installation

Caution: DO NOT tighten the screws during the installation process. To ensure better installation, please tighten the screws only AFTER all the wooden parts are assembled together.

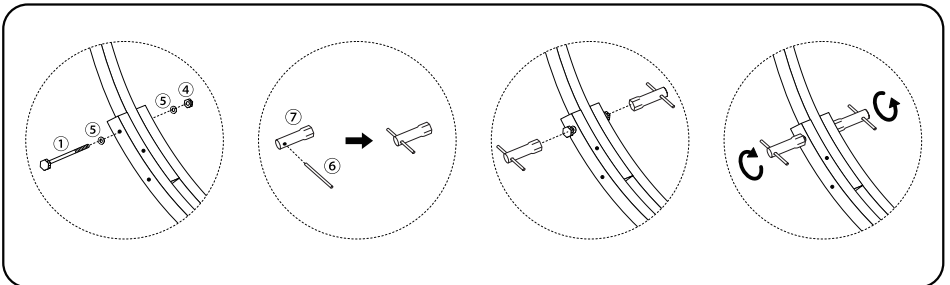

1

Assemble one foot bracket B onto two foot brackets A.

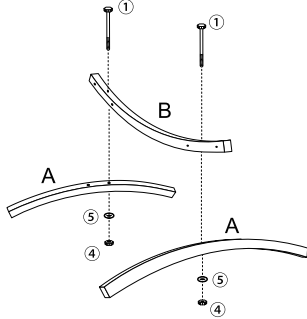
**2**

Install the other foot bracket B.

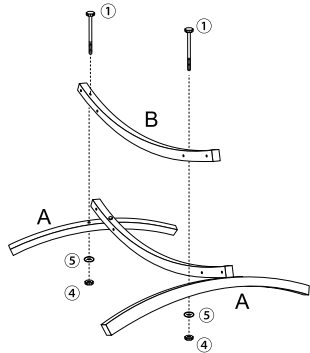
**3**

Install side poles C.

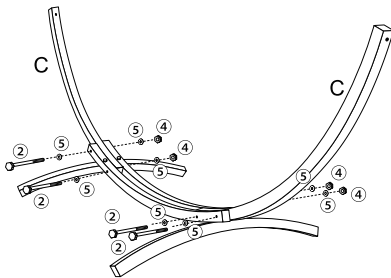
**4**

Tighten all the screws.

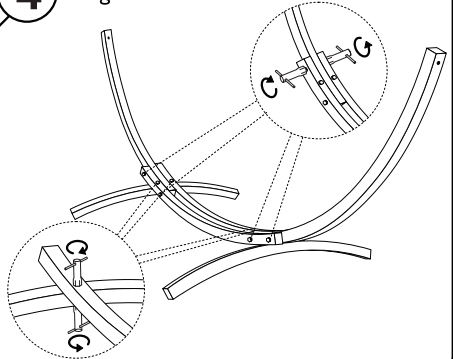
**5**

Install the eye screws ③.

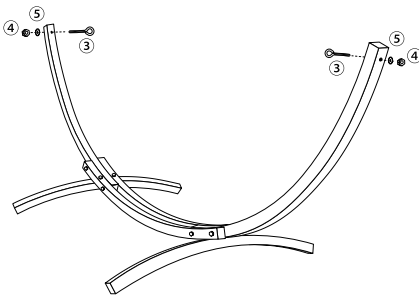
**6**

Install the hook ⑧ and Chain ⑩.

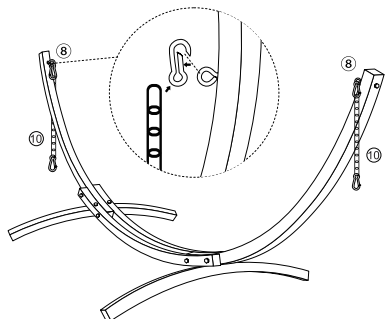

7

Install Screw Protection Cover ⑨.

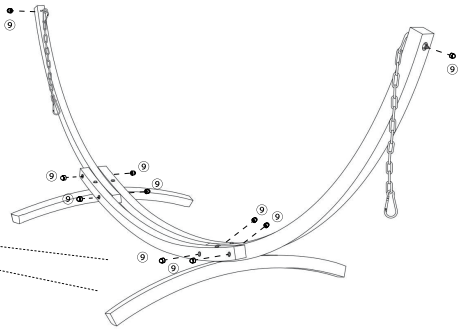
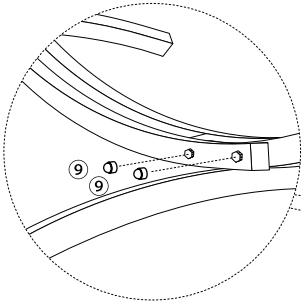

8

Installation completed.

