

Assembly Instructions

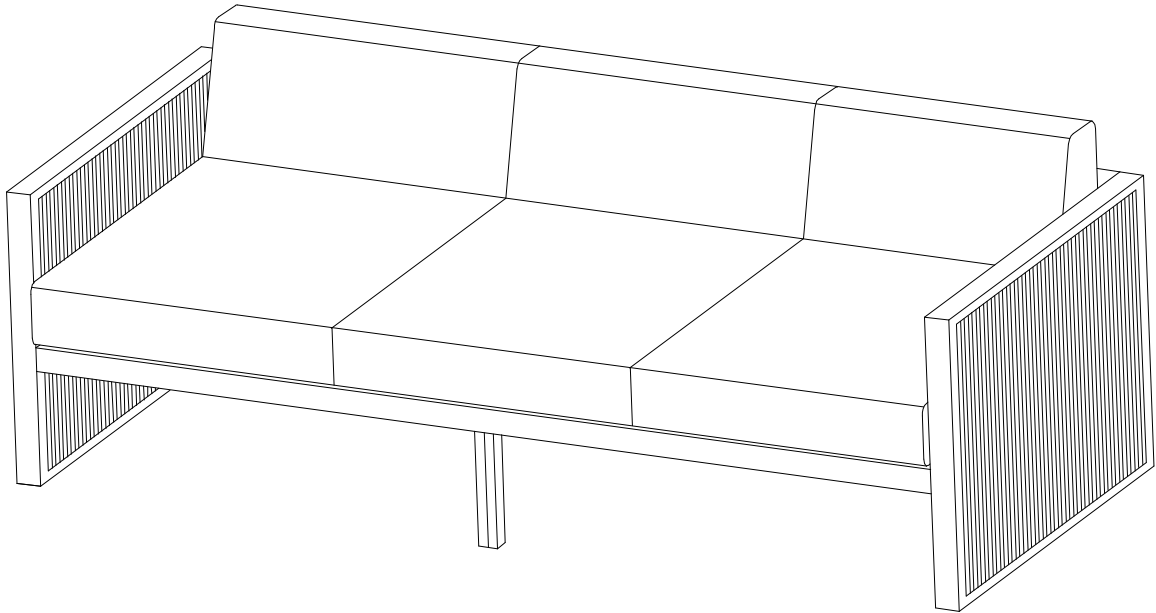







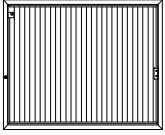
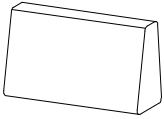
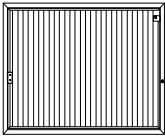

For any missing hardware, damaged parts and other problems. WELCOME to email us.

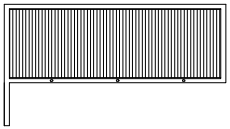
***Don't fully tighten all the bolts till the very end!**

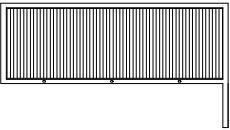
PRE-ASSEMBLY PREPARATION:

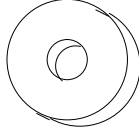
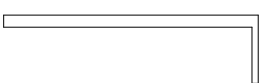
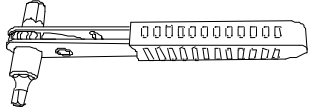
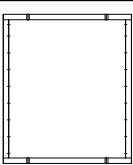
- Please read through the instructions before beginning assembly.
- Clear out the space for assembly and lay out all of the parts based on the Parts List, extra room will allow you to easily determine if all the pieces are present.
- Keep small parts and pieces away from children until fully assembled.

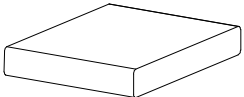
Part no.	Part	QTY	Image	Part no.	Part	QTY	Image
A1	Left arm	1		F	Back cushion	3	
A2	Right arm	1		G	Bolt (M6*40mm)	16	
B1	Left back panel	1		H	Bolt (M6*20mm)	2	
B2	Right back panel	1		I	Bolt (M6*15mm)	6	
C1	Left front panel	1		J	Washer M6	22	
C2	Right front panel	1		K	Ratchet wrench	1	
D	Seat panel	3		L	Allen wrench	1	
E	Seat cushion	3					

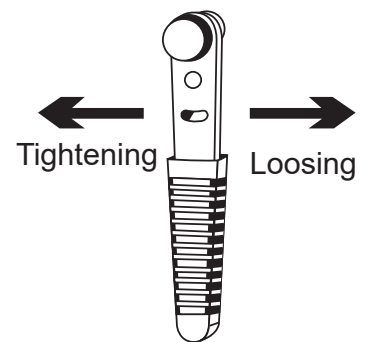
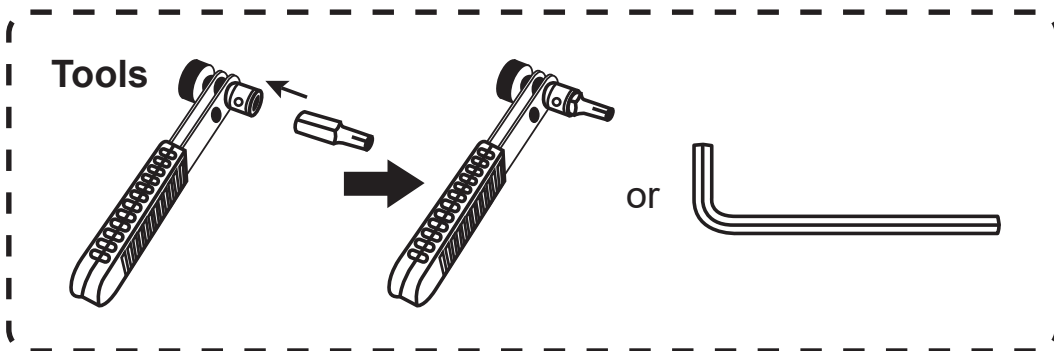

Step 1: Attach part B1 to part B2 on the same level, with 2pcs bolt G and 2pcs washers J, using Ratchet wrench K. Note: Don't fully tighten the bolts.

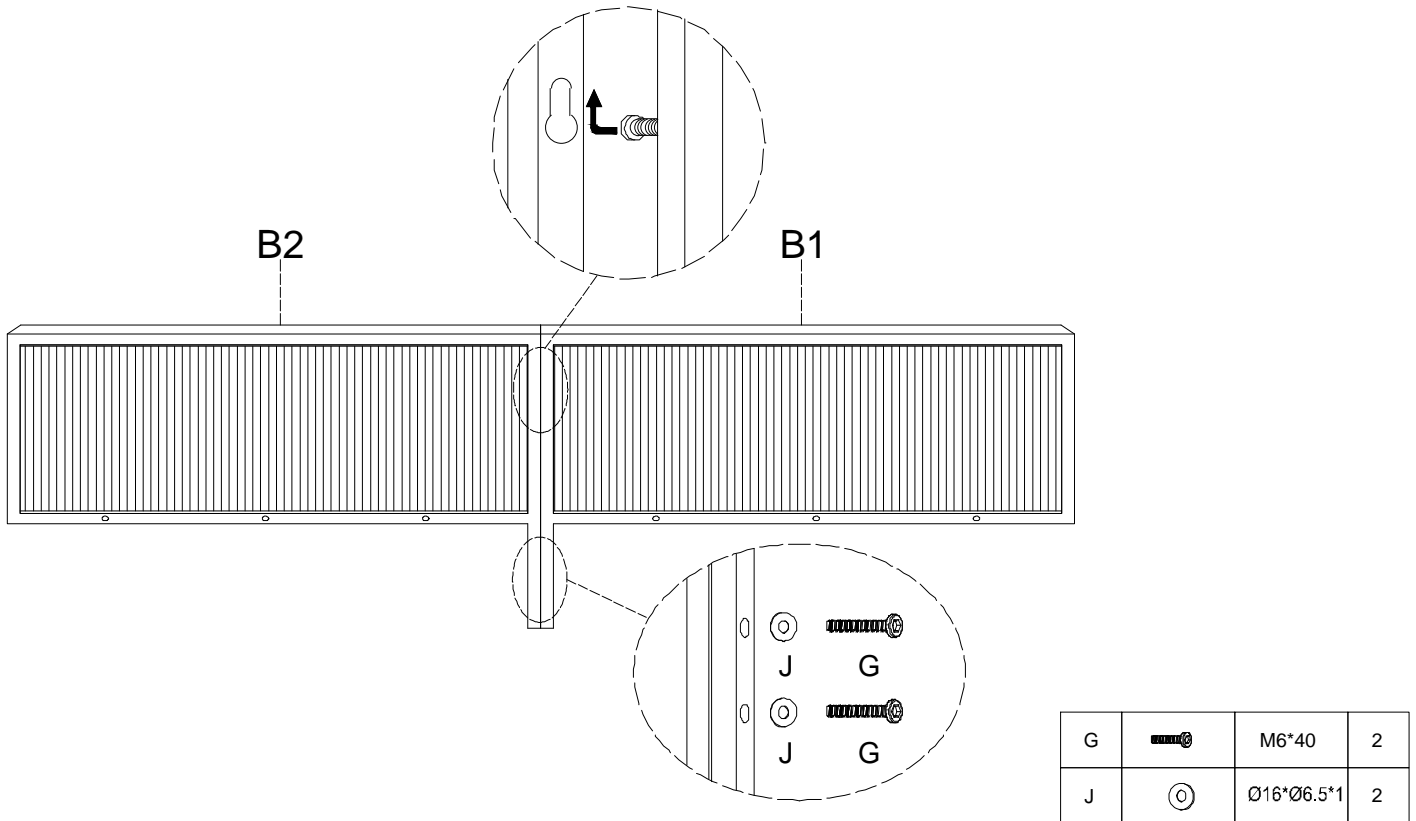

Step 2: Attach part C1&C2 with 2pcs bolts G and 2pcs washers J, using Ratchet wrench K. Note: Don't fully tighten the bolts.

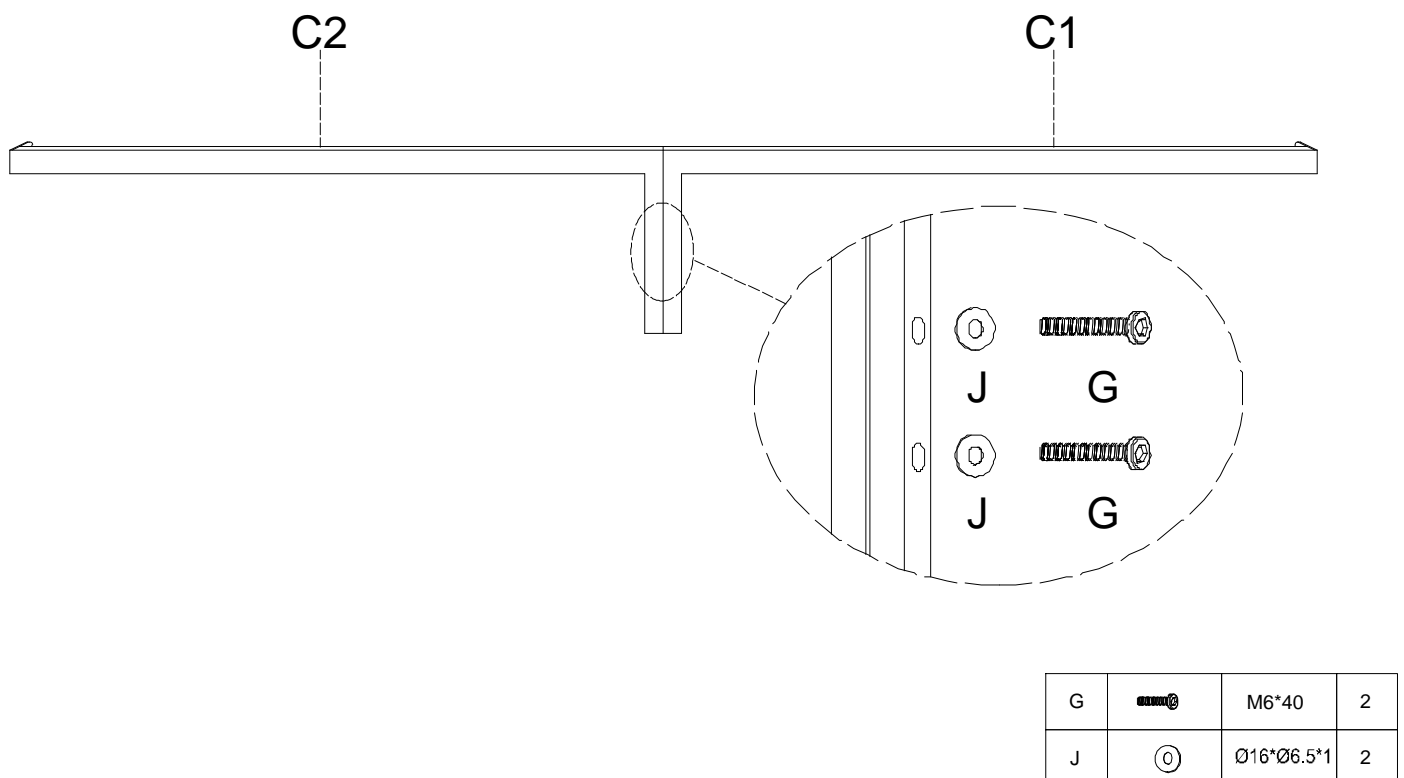

Step 3: Attach part A2 to Part B2 with 1pc bolt H, 1pc bolt I and 1pc washer J, using Ratchet wrench K. Note: Don't fully tighten the bolts.

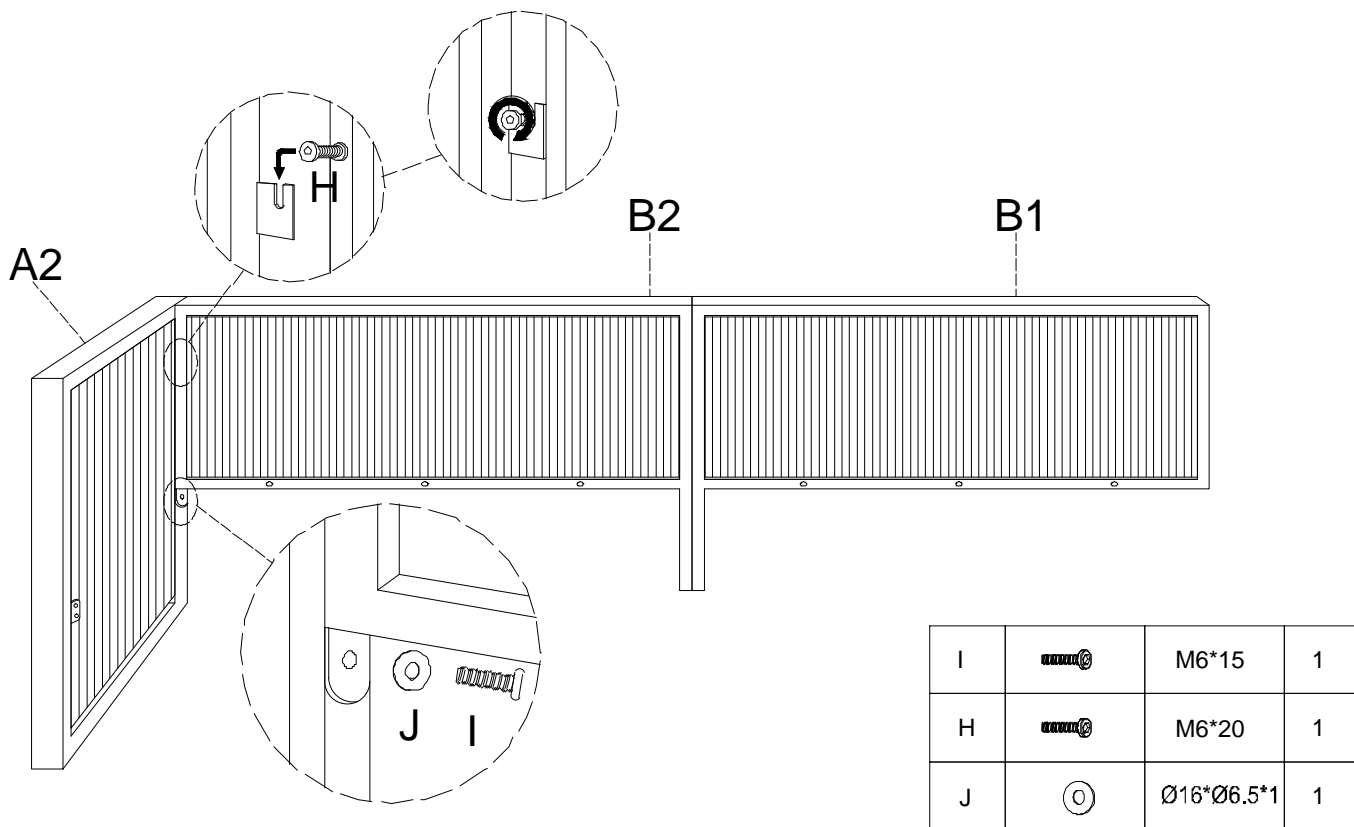

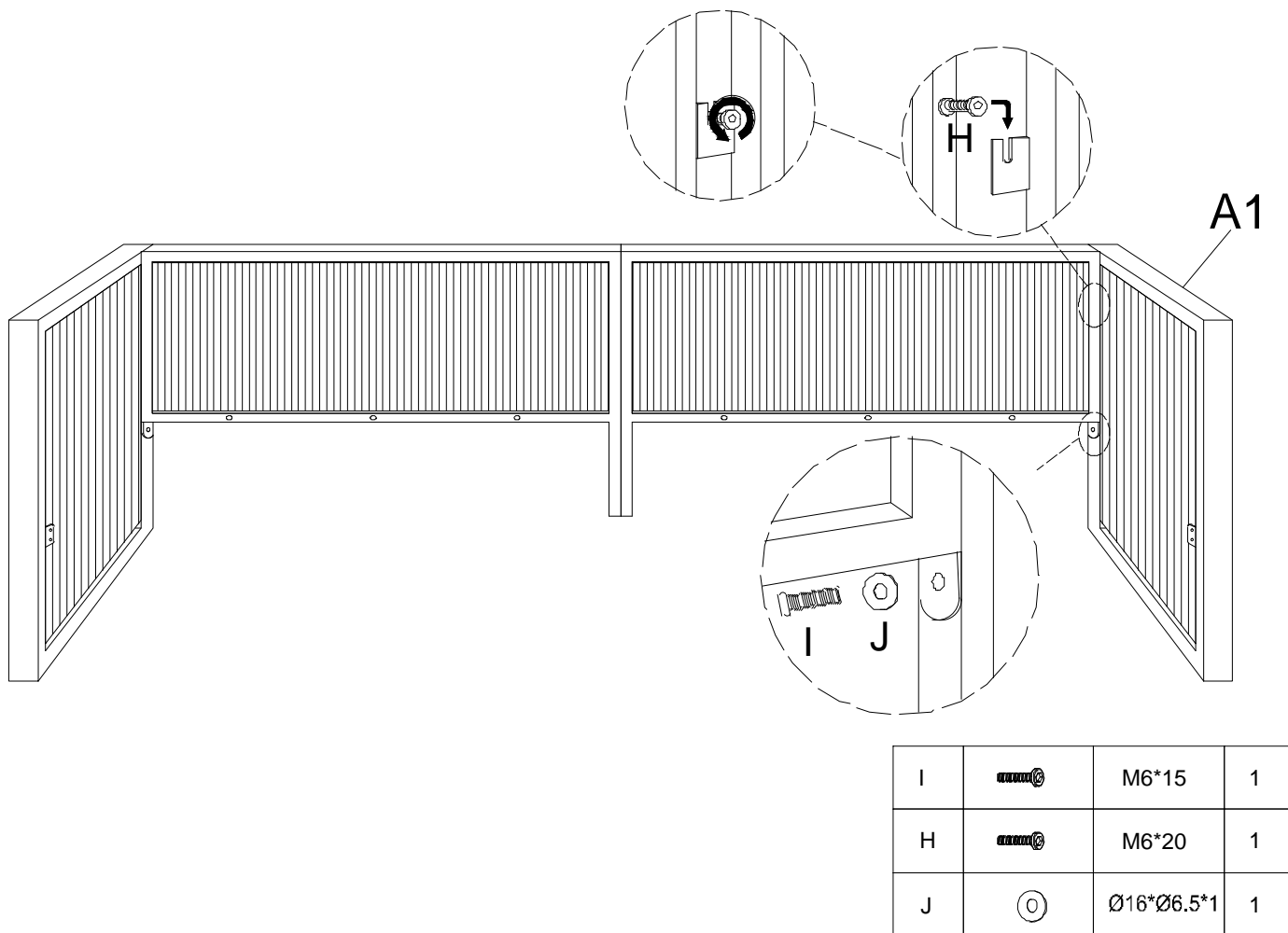

Step 4: Attach part A to Part B1 with 1pc bolt H, 1pc bolt I and 1pc washer J, using Ratchet wrench K. Note: Don't fully tighten the bolts.



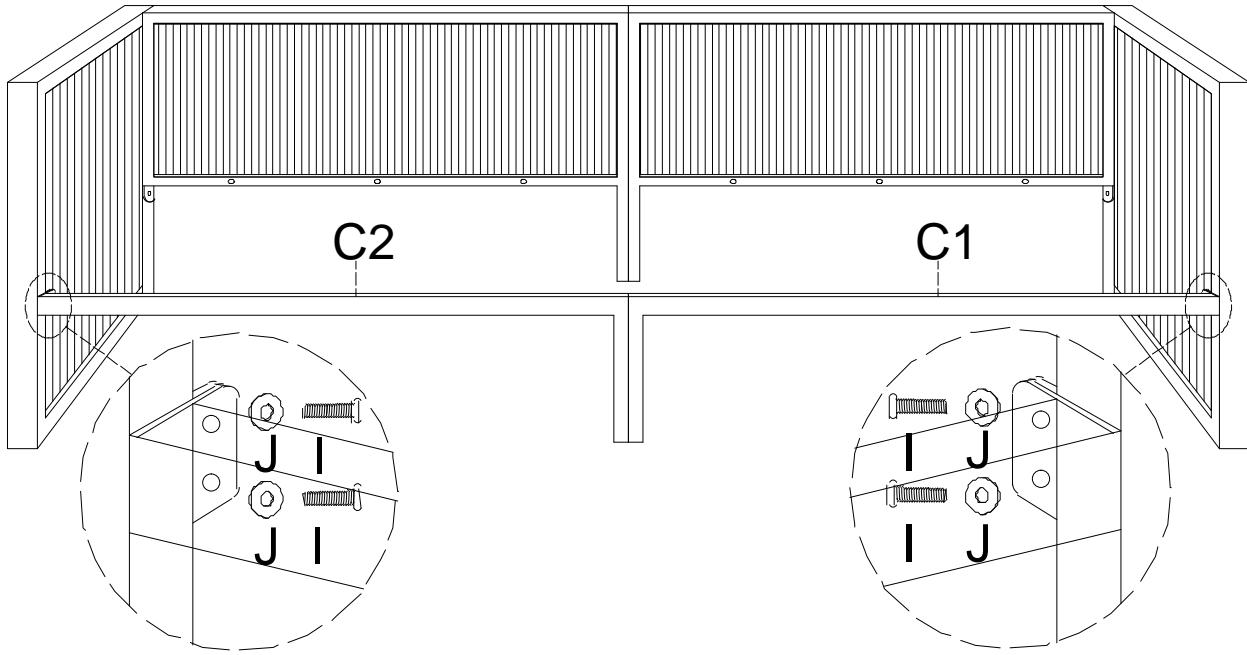

Step 5: Attach part C1&C2 to arm panels with 4pcs bolts I and 4pcs washers J, using Ratchet wrench K. Note: Don't fully tighten the bolts.

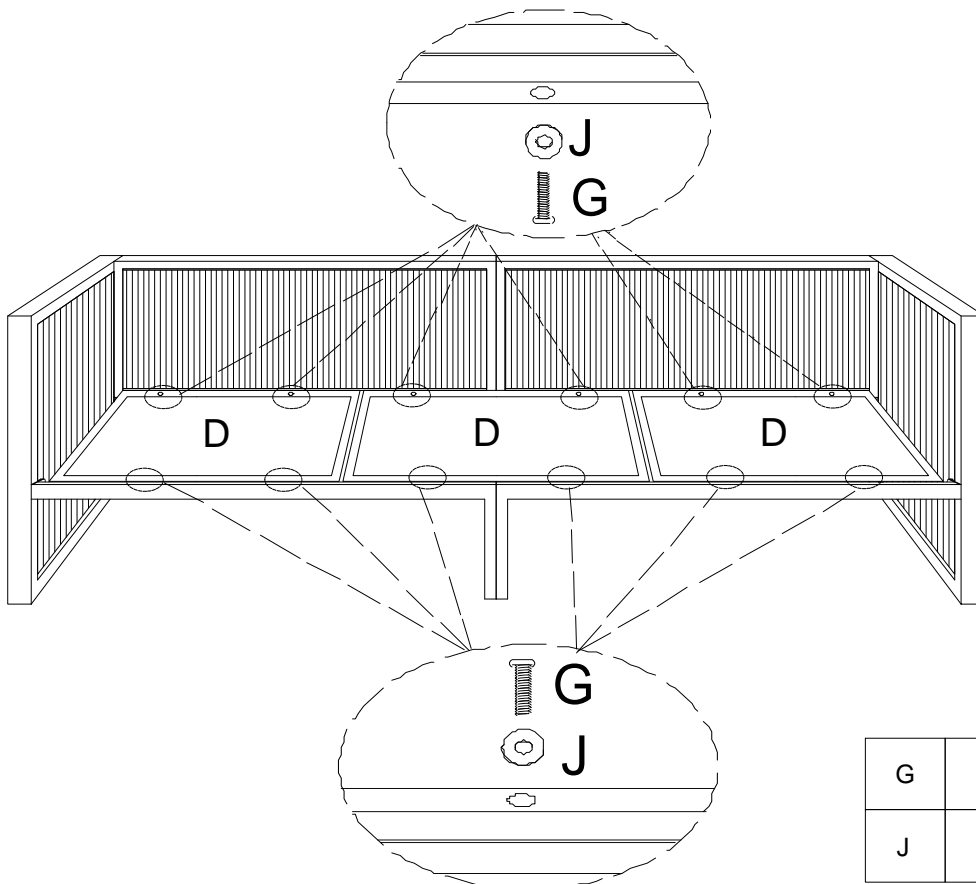

I		M6*15	4
J		Ø16*Ø6.5*1	4

Step 6: Attach parts D to back panels and front panels with 12pcs bolts G and 12pcs J, using Ratchet wrench K. Note: Don't fully tighten the bolts.



G		M6*40	12
J		Ø16*Ø6.5*1	12

Step 7: Put seat cushions E and back cushions F onto the seat.
Assembly is now complete and the product is ready for use.

