























Assembly Instructions

Care & Maintenance

 	<ul style="list-style-type: none">● Not for commercial use. For residential use only.
 	<ul style="list-style-type: none">● Furniture may scratch floors. We recommend using furniture pads to protect your floors.
 	<ul style="list-style-type: none">● Do not put hot items directly on furniture surface.
 	<ul style="list-style-type: none">● Do not clean furniture with harsh cleansers or polish.
 	<ul style="list-style-type: none">● Do not place furniture under direct sunlight.
 	<ul style="list-style-type: none">● Do not place furniture near heating or cooling vents.
 	<ul style="list-style-type: none">● Do not write on furniture without a padded barrier to protect the surface.
 	<ul style="list-style-type: none">● Do not place furniture outside. For indoor use only.
 	<ul style="list-style-type: none">● Stains may be removed with mild soap solution and damp cloth.
 	<ul style="list-style-type: none">● Children should not climb or jump on the furniture.
 	<ul style="list-style-type: none">● Dust and pick-up spills using a clean, non-colored, lint-free cloth.

Please look in the box for hardware packs and legs.

Sets often ship in multiple boxes and may arrive a day or two apart.

King Bed

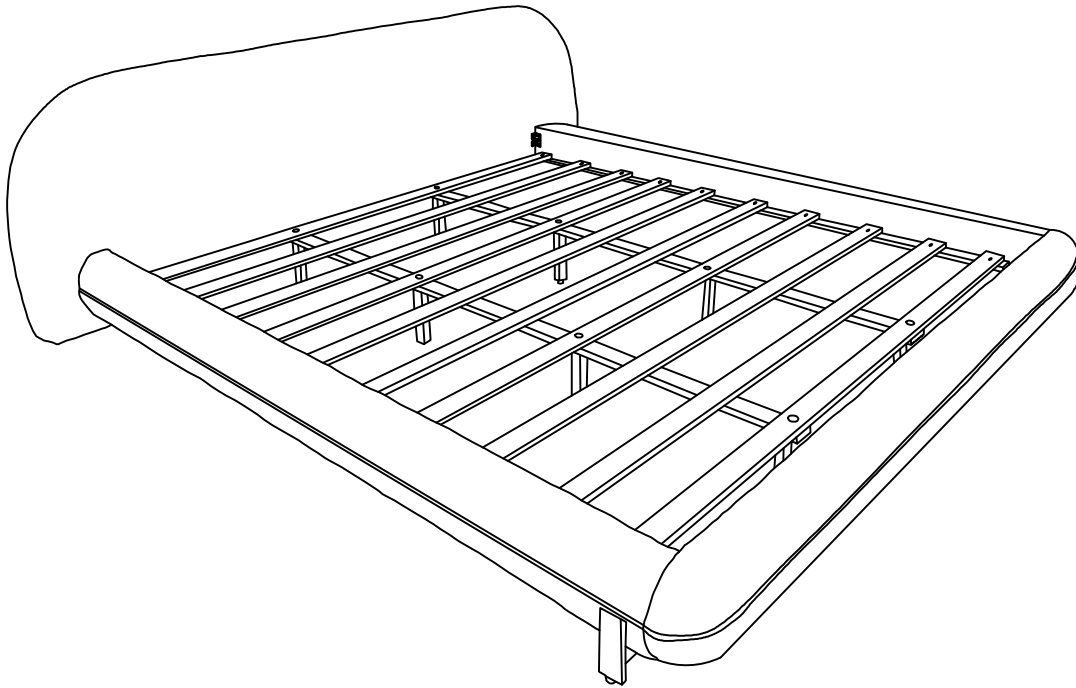



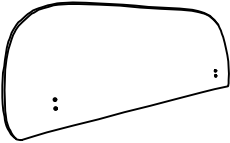
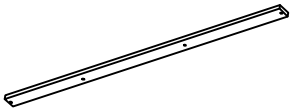
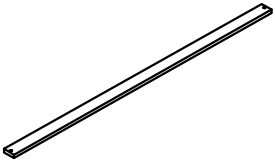
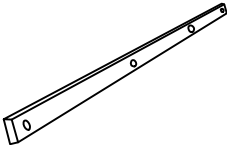



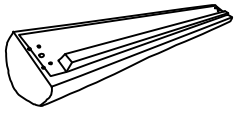
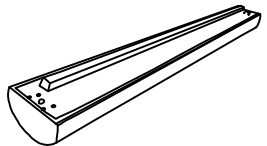
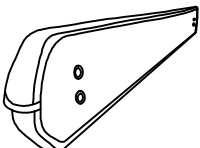
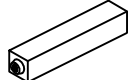
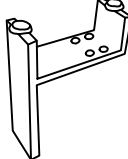

Part List

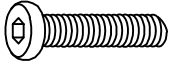
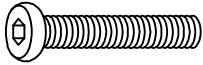
Label	Picture	Description	QTY
④		Headboard	1
⑤		Slats	4
⑥		Slats	6
⑧		Center Support bar	2

Part List

Label	Picture	Description	QTY
①		Side Panel(R)	1
②		Side Panel(L)	1
③		Footboard	1
⑦		Center Supportbar fitting	8
⑨		Bed leg	2

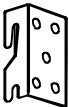





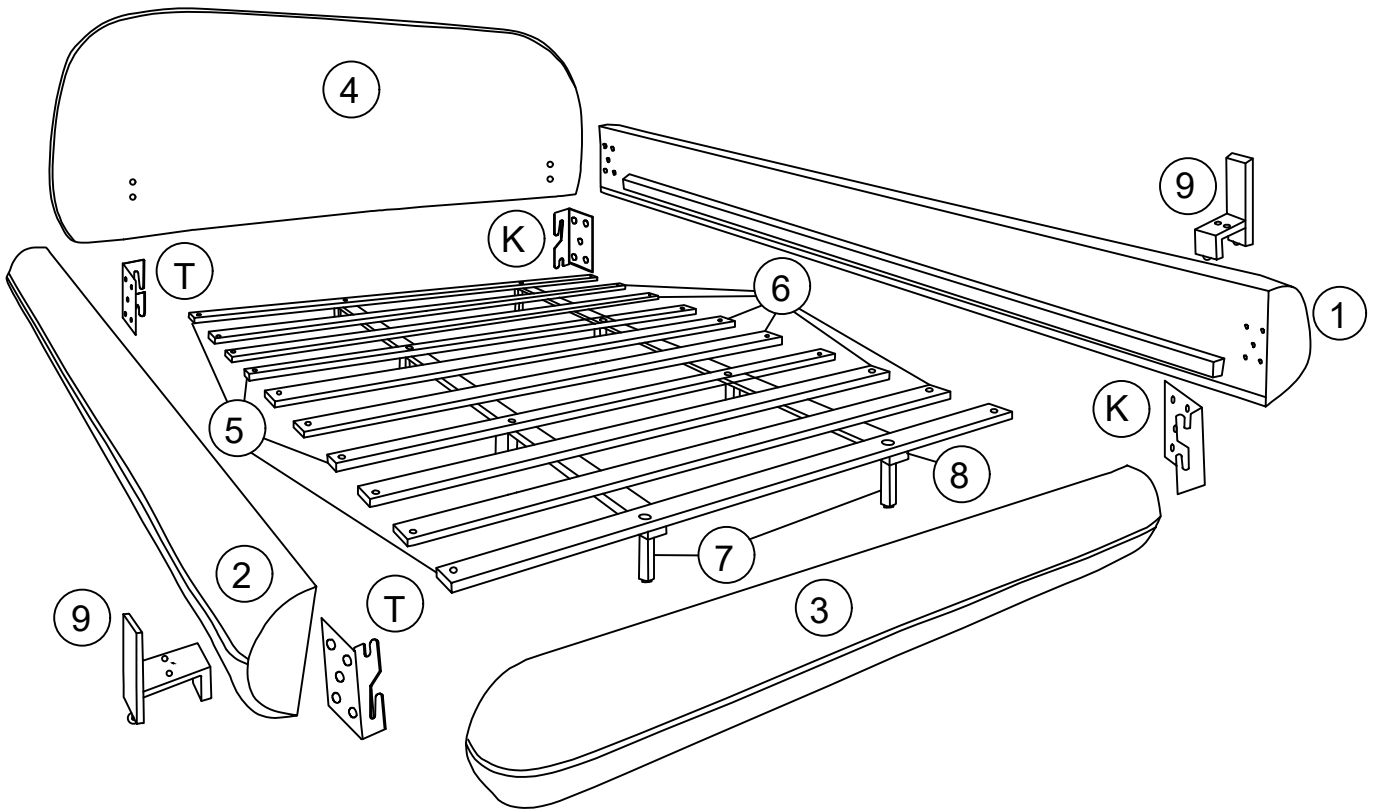

Hardware



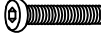

Label	Picture	Description	QTY
(A)		Screw(4x30mm)	36+1
(B)		Bolts(1/4x30mm)	4+1
(C)		Bolts(5/16x40mm)	12+1
(D)		Bolts(1/4x60mm)	8+1
(E)		Spring washer(5/16x20mm)	12+1
(F)		Flat washer(5/16x20mm)	12+1
(G)		Spring washer(1/4x18mm)	12+1
(H)		Flat washer(1/4x18mm)	12+1
(T)		Hinge(L)	2
(K)		Hinge(R)	2
(M)		Allen wrench(M4)	1+1

Assembly Preparation

Before Beginning assembly:



A		x36pcs+1	F		x12pcs+1
B		x 4pcs+1	G		x12pcs+1
C		x12pcs+1	H		x12pcs+1
D		x8pcs+1	M		x1pcs+1
E		x12pcs+1			

-  • Read instructions, cover to cover
-  • Have 2 adults on hand for assembly
-  • Do not assemble on flooring or carpet
-  • Assemble on a clean non-marring surface (packing foam)
-  • Save all packaging until finished

Assembly Steps

OVERVIEW

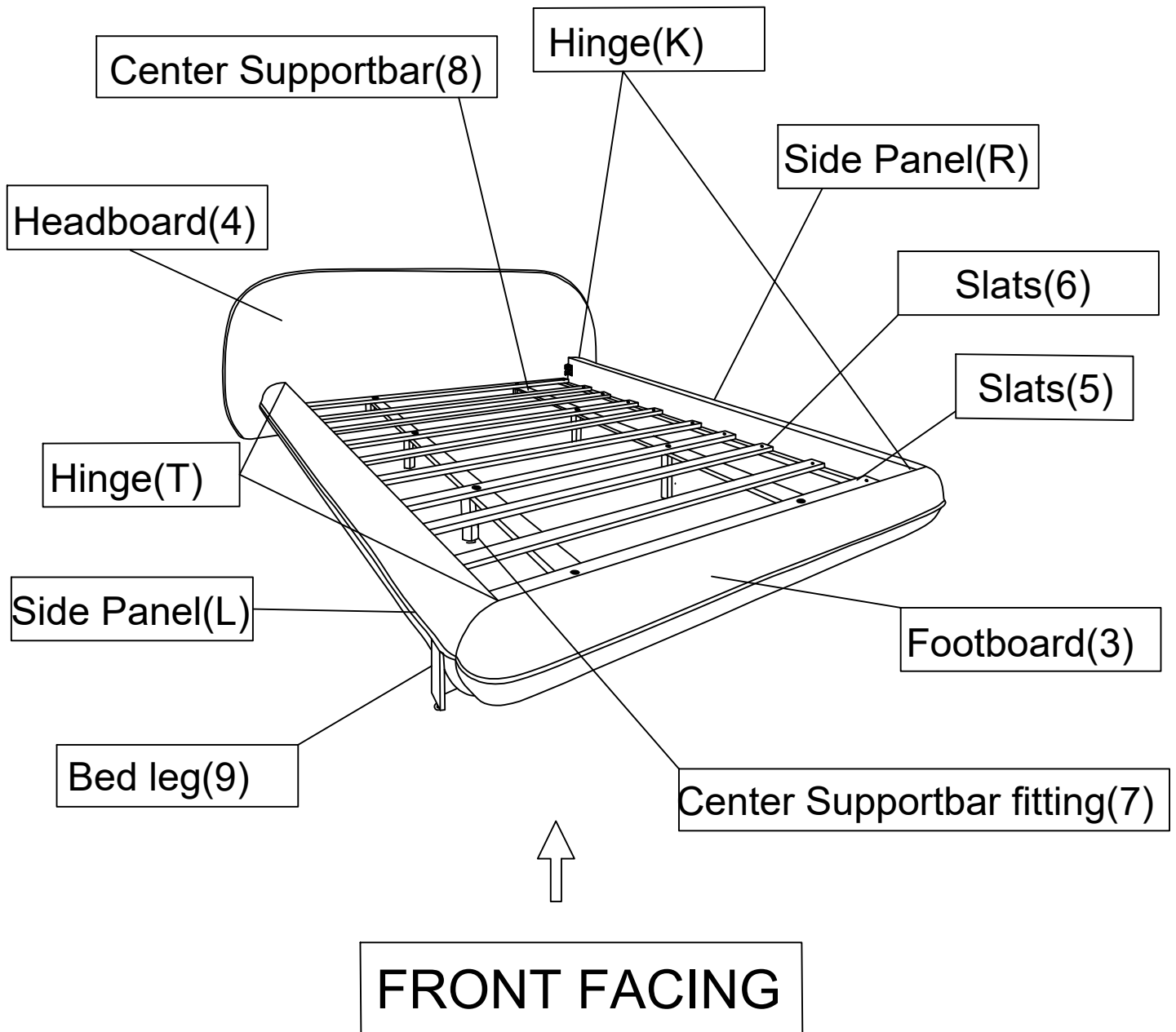

This Bed have multiple parts and may require up to 30 minutes to assemble. To give you an overview of the Bed parts, the above picture is to help you put the various parts into perspective. Please read through the instructions below to familiarise yourself with the parts and steps before assembly.

Note: It is recommended that you have an adult partner to assist during the entire assembly process.

Step1

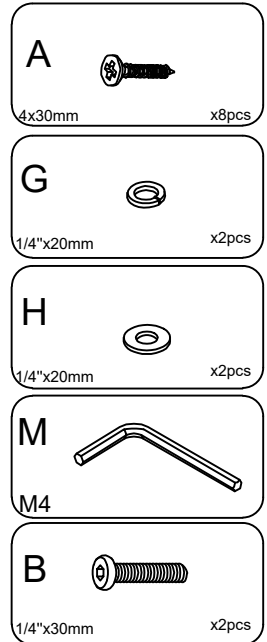
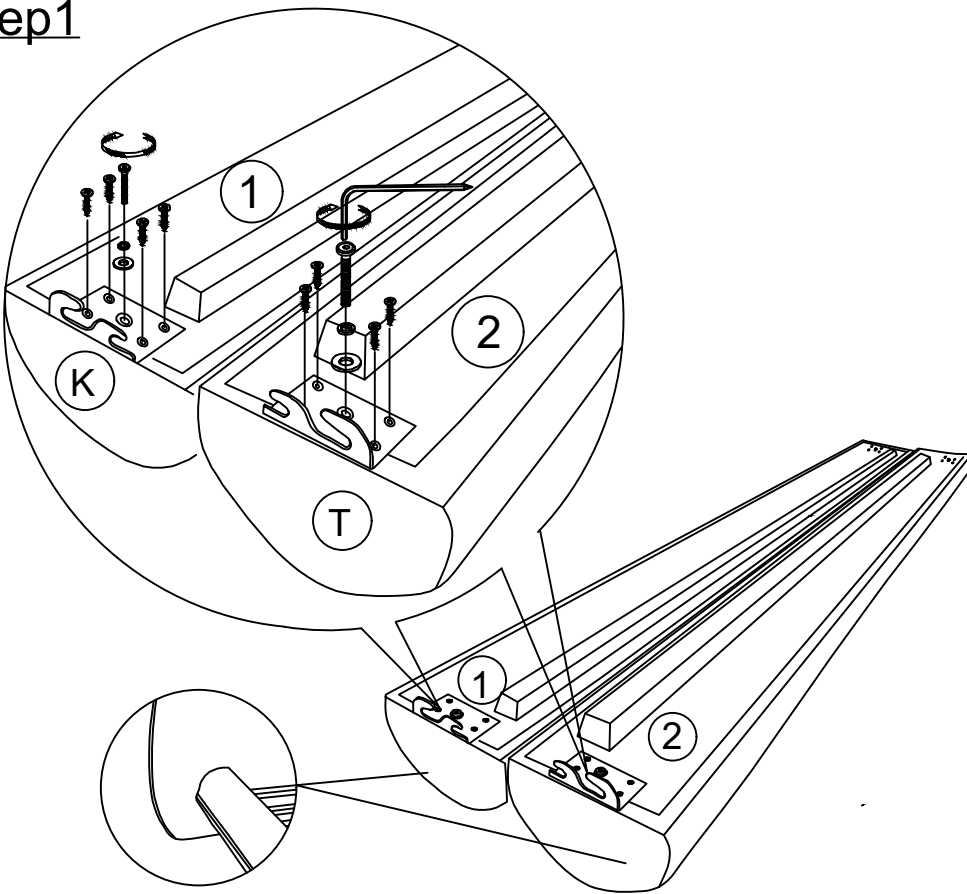

Step 1: Attach the Hinge (R) (K) to the Side Panel (R) (1), attach the Hinge (L) (T) to the Side Panel (L) (2). By using the Bolts (B) and Flat Washer (H) with the Spring Washer (G) and Screw (A) to connect the Hinge and the Side Panel (Note: The hinge hook is facing down and this place is connected to the Headboard (4))

Step2

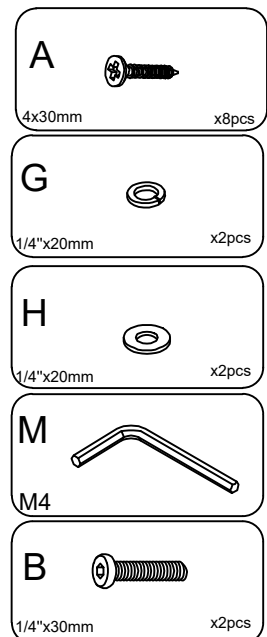
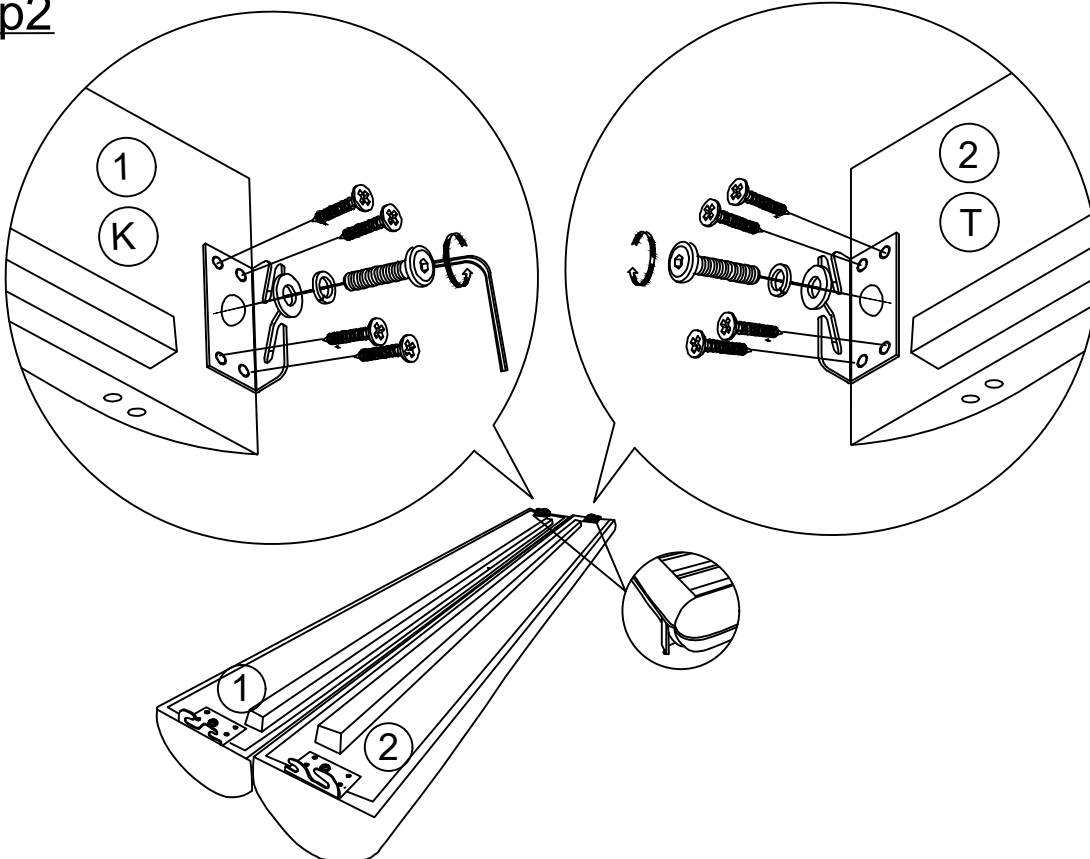

Step 2: Use the Hinge (K) to attach to the Side Panel (R) (1), use the Hinge (T) to attach the Side Panel (L) (2). By using the Screw (A) and the Bolts (B) with M4 Allen Wrench (M) to connect the Hinge and the Side Panel (Note :The direction of the Hinge and this place is connected to the Footboard (3)).

Step3

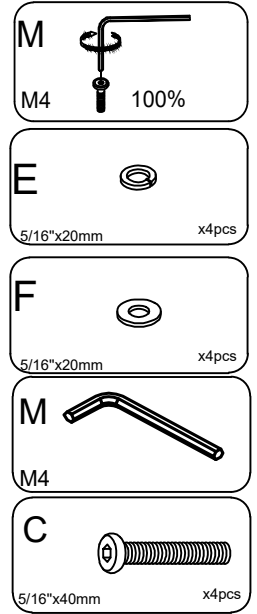
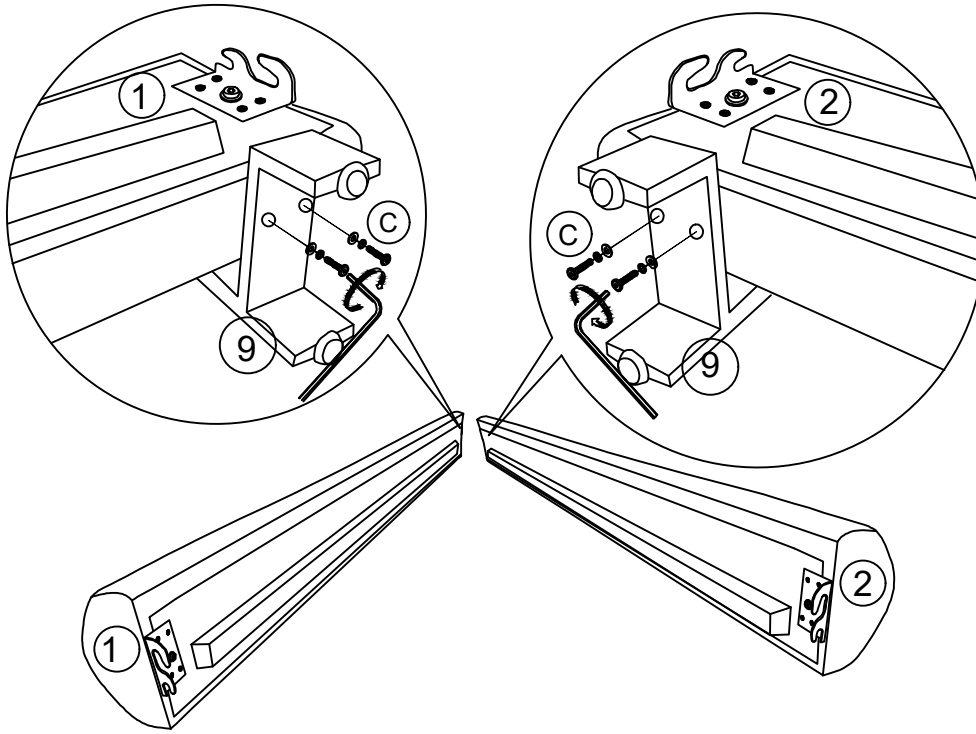

Step 3: Attach the Bed Leg (9) to the Side Panel (R) (1) and the Side Panel (L) (2). By using the Bolts (C), the Flat Washer (F) and the Spring washers (E) with M4 Allen Wrench (M) to connect the Bed Leg and the Side Panel.

Step4

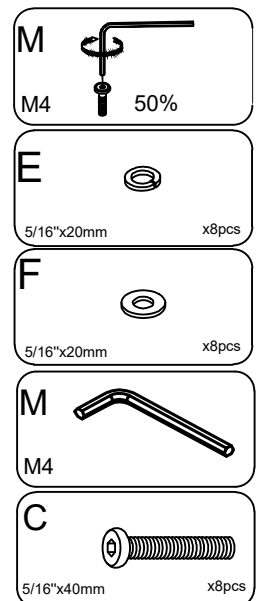
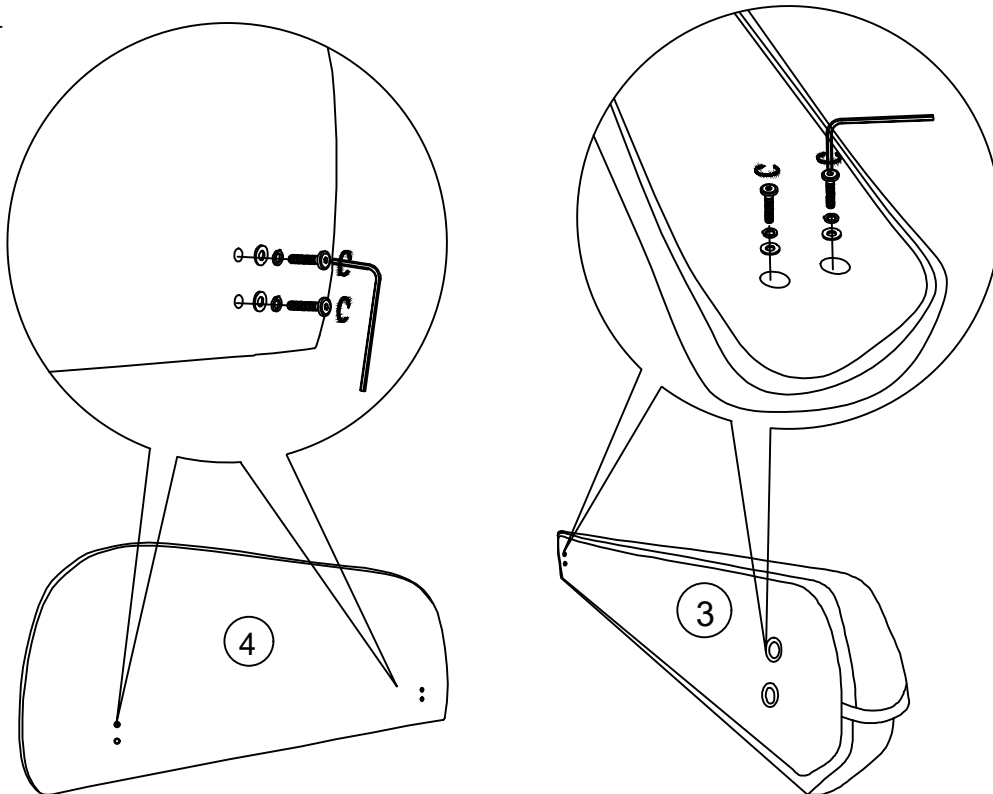

See the **Headboard (4)** and **Footboard (3)** in the **Flange (F)** when attaching 12 **Headboard (4)** and **Footboard (3)**

Step5

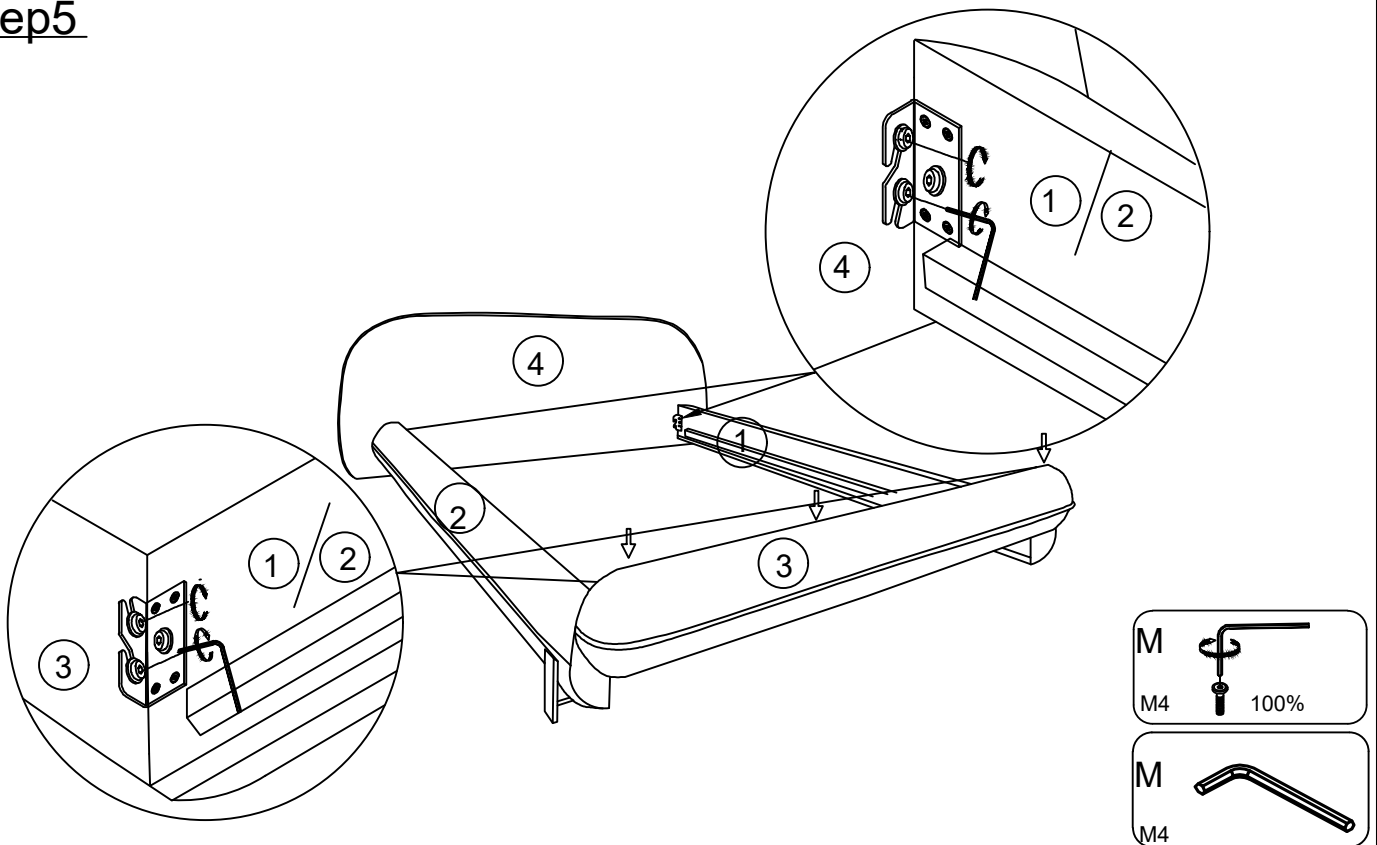

Step 5: Attach the Side Panel (1) and the Side Panel (2) to the Headboard (4) (**Note: the direction of the Hinge is down**), by using M4 Allen Wrench (M) to tighten the Bolts (C). Then attach the Footboard (3) to the Side Panel (1) and the Side Panel (2) (**Note: the direction of the Hinge is up**), by using M4 Allen Wrench (M) to tighten the Bolts (C).

Step6

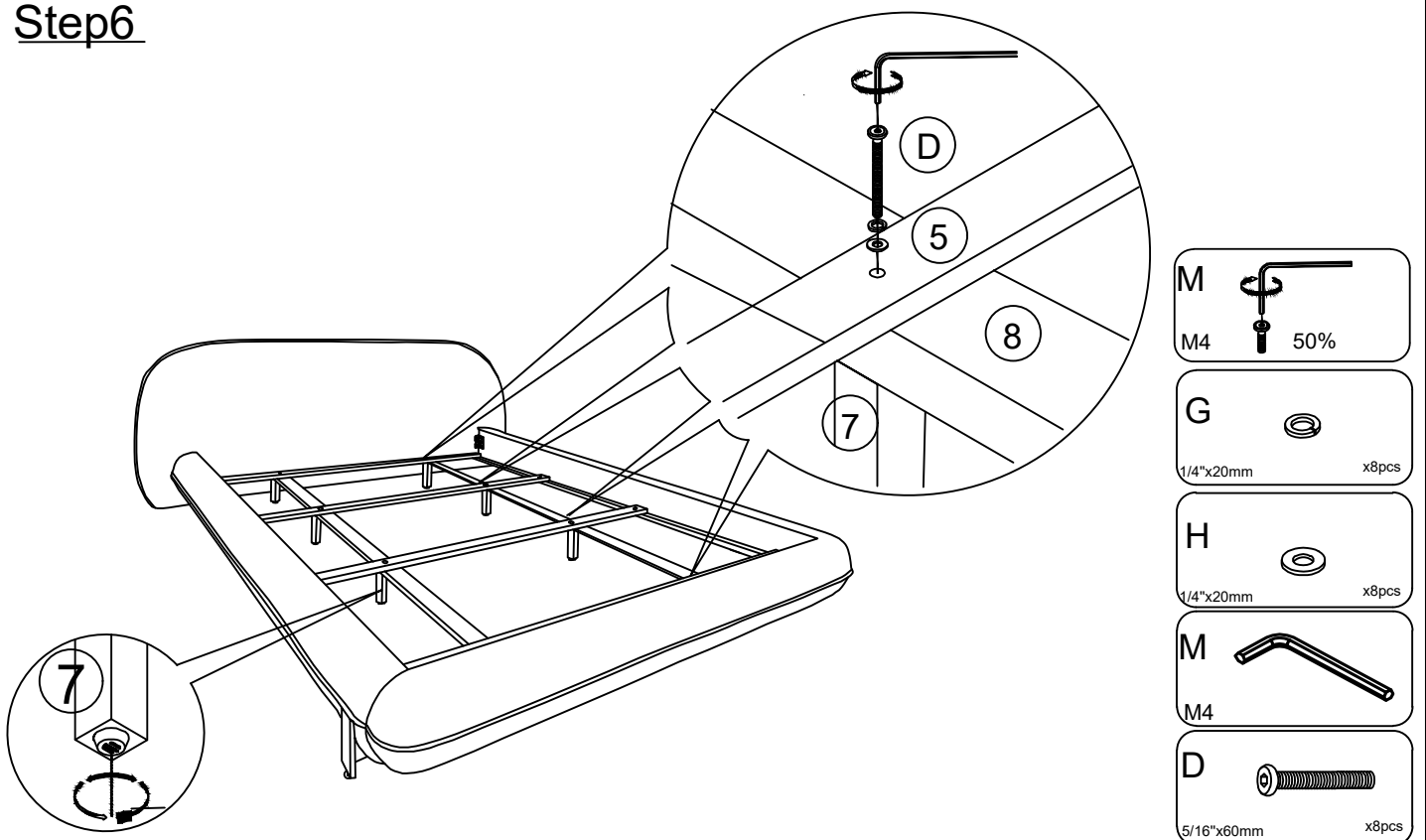

Step 6: Align the assembly position on the Center Support Bar (8) with the Center Support Bar Fitting (7) and the Slats (5). Then attach the Slats (5) and the Center Support Bar (8) to the Center Support Bar Fitting (7) . By using the Bolts (D) with M4 Allen Wrench (M).

Step7

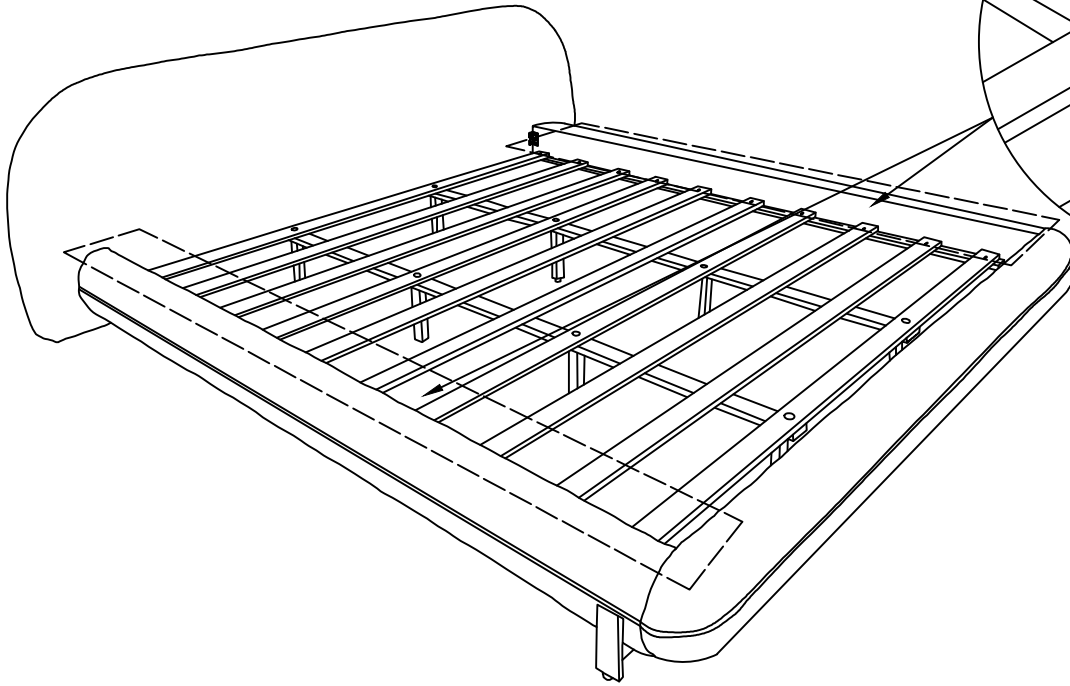

A



4x30mm

x20pcs

Step 7 :Assemble the support bars (5) to the bed sides rails (1) and (2). Use screw A

Step8

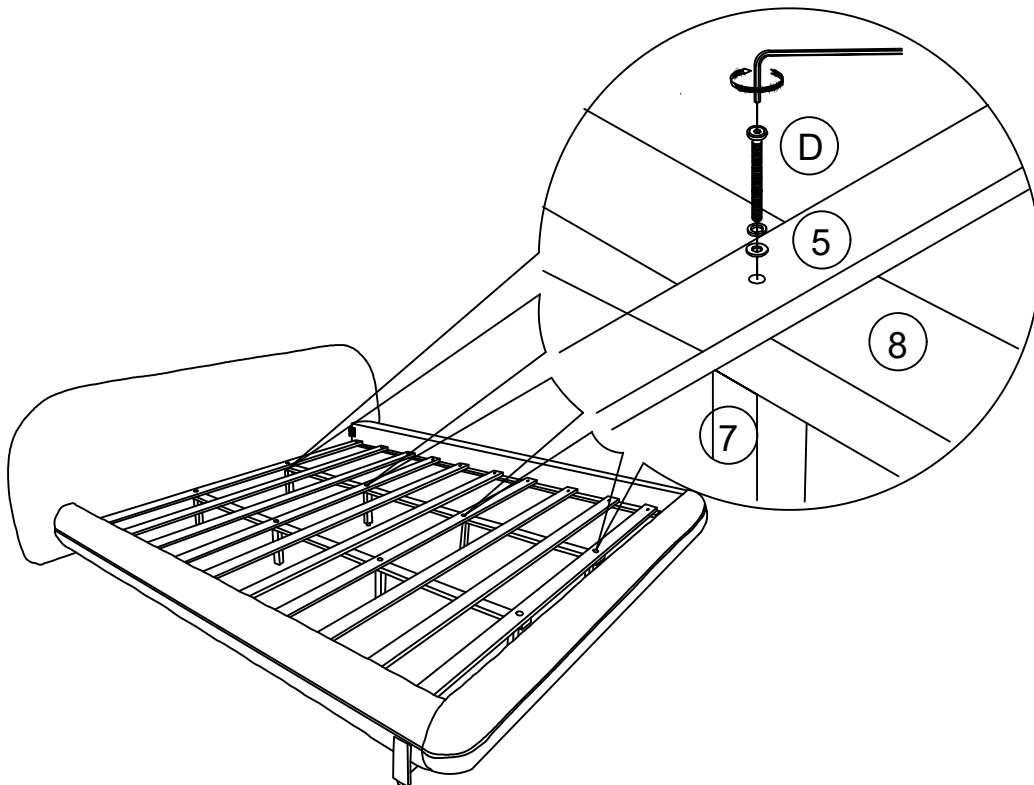

M

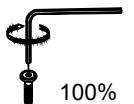

M4

100%

Step 8: Finally, use the M4 Allen Wrench (M) to tighten the Bolts (D) 100%

Step9_Finished

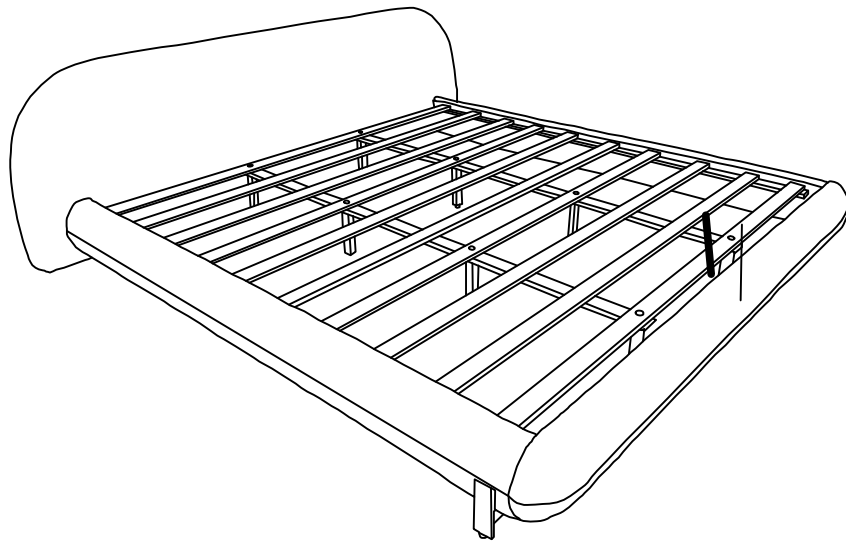

Noted : Slats (5) Slats (6) and Center Support bar are packaged behind the Headboard (4).

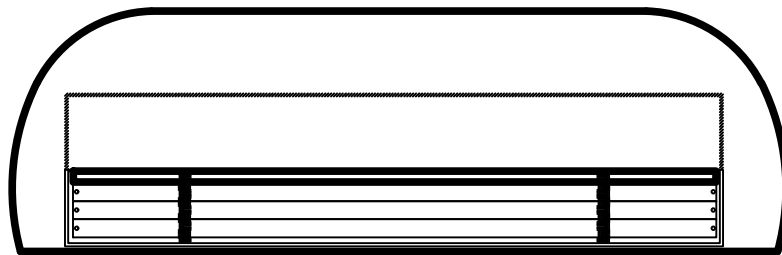

Thank you for your trust and preference in using our products.
The product will bring you a peaceful sleep forever