

Owner Manual



Per Seat Weight Limitation
300 LBS



Installation:
10 minutes.







Two Person

MAINTENANCE AND WARNINGS



Before You Start

Please follow the steps below:



-  Check the packaging for any damage, deformation, or water stains. If there is significant damage, please contact us promptly.
-  Unpack the box and compare the contents with the parts list and hardware list to ensure all components and accessories are present and complete.
-  Please read the installation instructions carefully to understand the installation steps and precautions to ensure proper installation.
-  Clean the installation area in advance and ensure the ground is level and there is enough space to avoid damaging the furniture or making installation difficult.
-  Lay a protective mat on the ground to prevent scratching the floor during installation.

After-Sales Service

- If you encounter any issues or need technical support during use, please contact our after-sales team. We offer long-term maintenance and warranty services.





Precautions

-  This product is for indoor use only. Do not expose it to outdoor elements or high-humidity environments.
-  Keep the product away from high heat or open flames to prevent fire hazards.
-  Do not allow children to climb on the product, as this may cause tipping and result in personal injury.



Safety Warnings

-  If you notice any loose or damaged parts, stop using the product immediately and contact customer service.
-  Do not attempt to disassemble or replace any components yourself, as this may affect the stability and safety of the product.

Daily Maintenance

- Regularly clean the surface with a soft cloth to prevent dust accumulation.
- Do not use cleaning agents containing acids, alkalis, or corrosive substances, as they may damage the surface. It is recommended to use neutral cleaning agents or specialized furniture cleaners.
- Avoid exposing furniture to humid environments for extended periods. Use a dehumidifier or desiccant during humid weather.
- Avoid direct contact of furniture with water. If water is accidentally spilled, wipe it dry immediately.
- Avoid placing excessively heavy objects on the furniture: ensure the weight is within a reasonable load-bearing range.
- Avoid using sharp or rough items on the furniture surface to prevent scratches. Handle items gently when moving them.

Explosive view

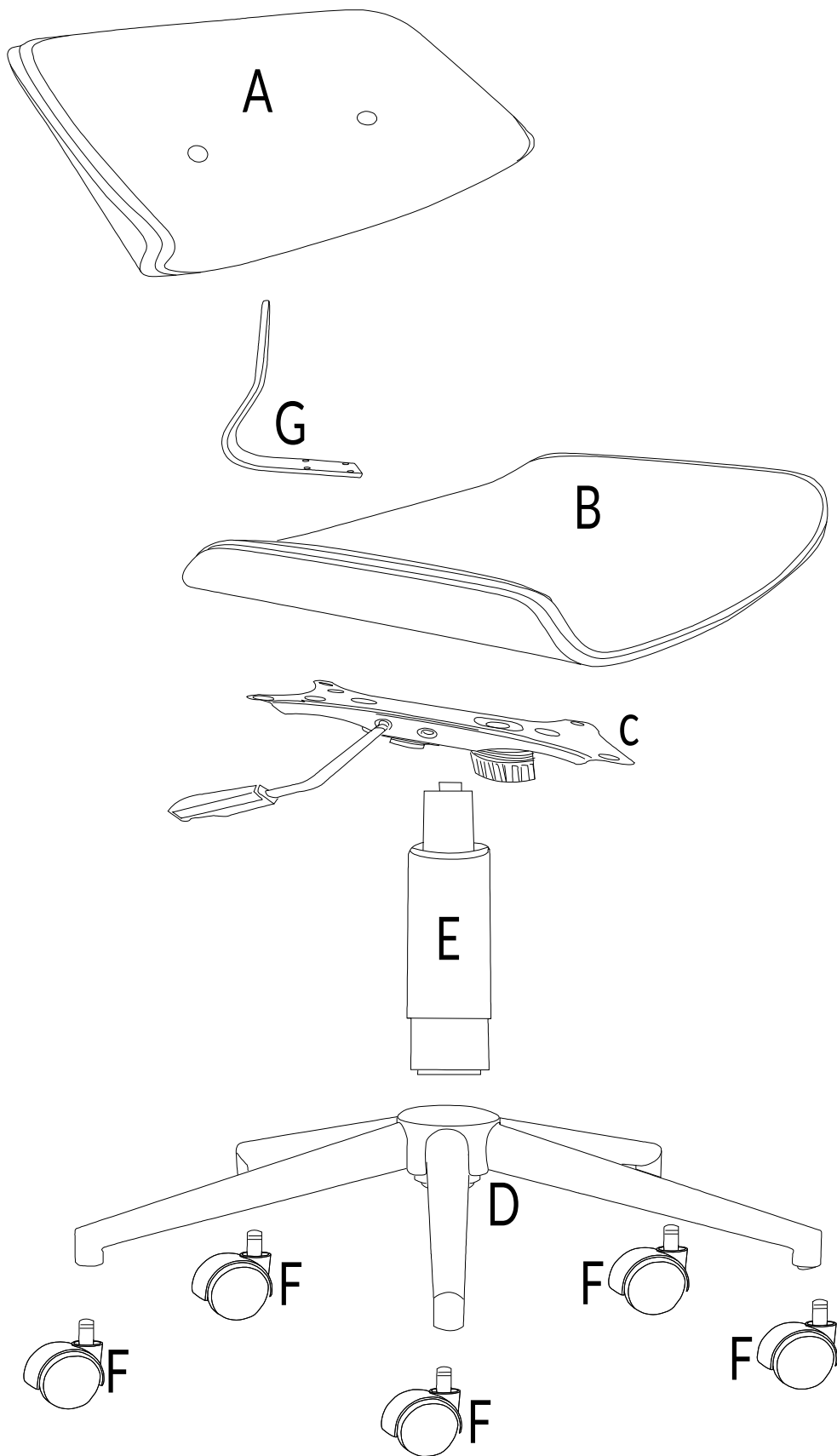

Parts list

Box A

A x1 Back

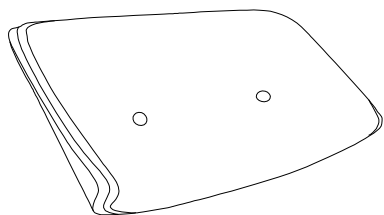

B x1 Cushion

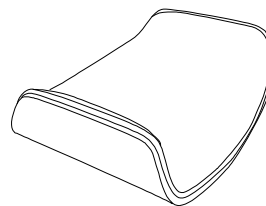

C x1 Regulator

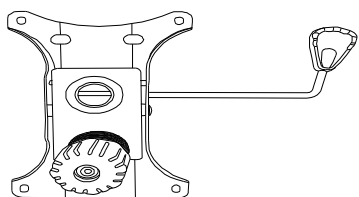

D x1 Leg

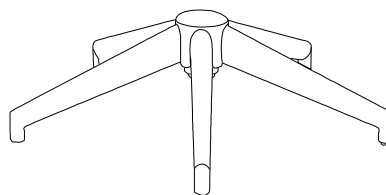

Box B

E x1 Gas lift

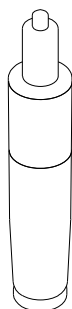

F x5 Wheels

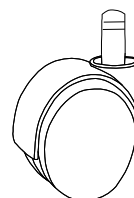

G x1 Connecting rod

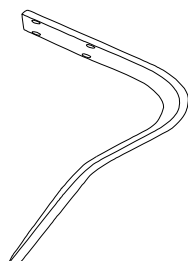

Hardware List

①x1 Wrench



②x4+1 Screw

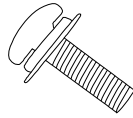

M6*20MM

③x4+1 Screw

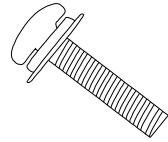

M6*30MM

④x3 Screw



M6*25MM



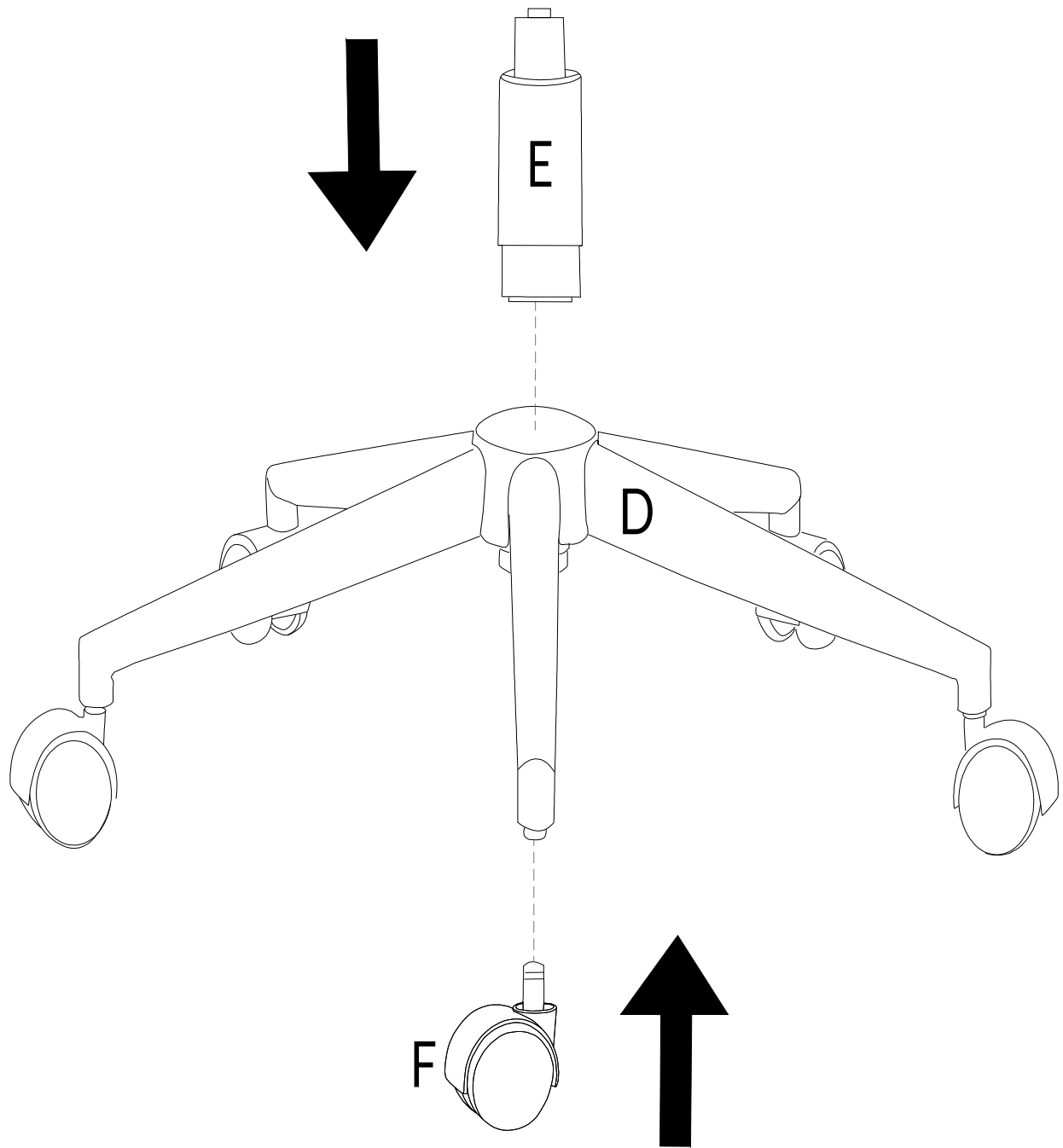

Note: Before installing the screws, please first distinguish the length of the screw rods.

Step 1

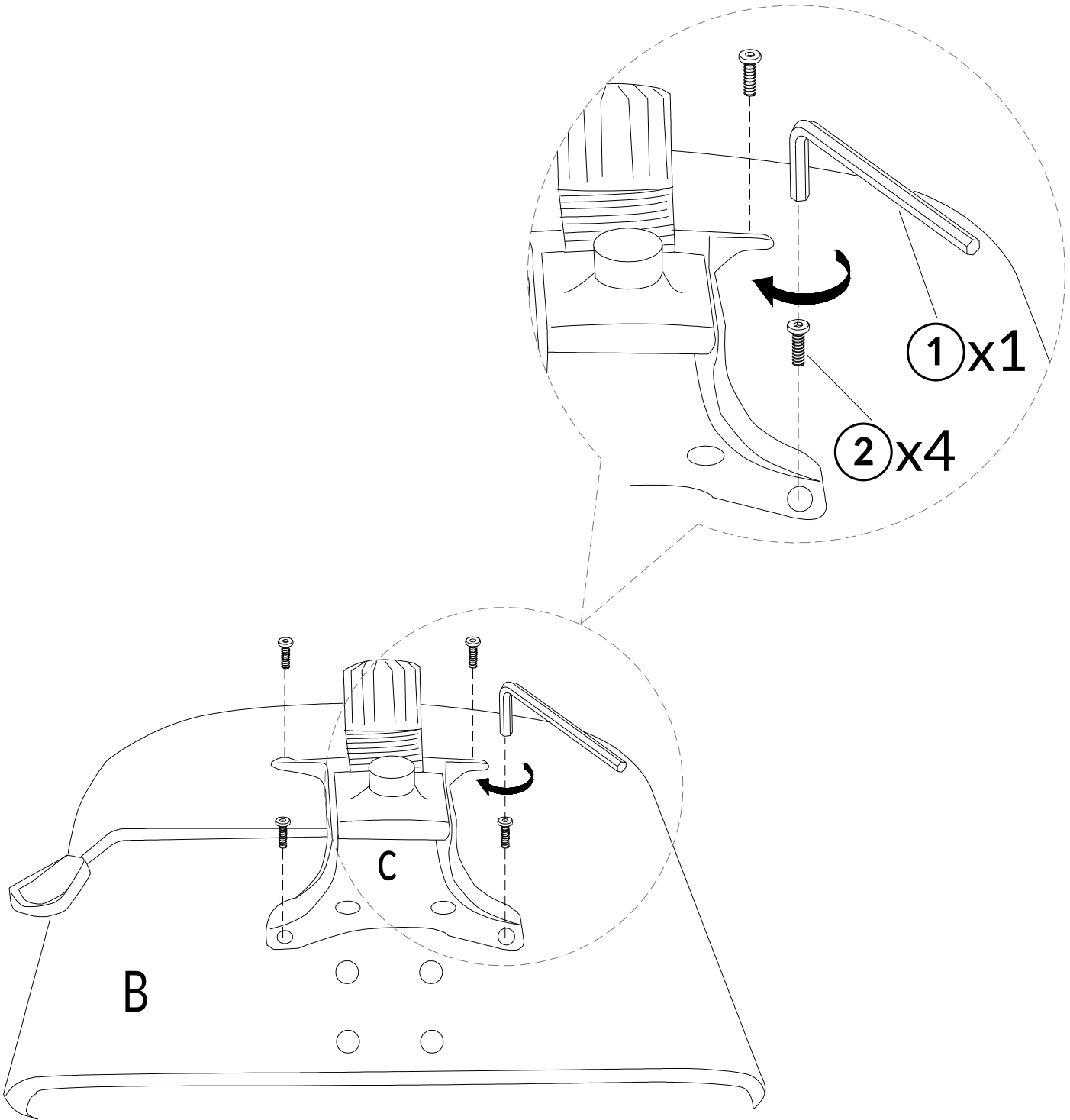

Step 2

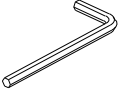

②x4	①x1
	
M6*20MM	

Step 3

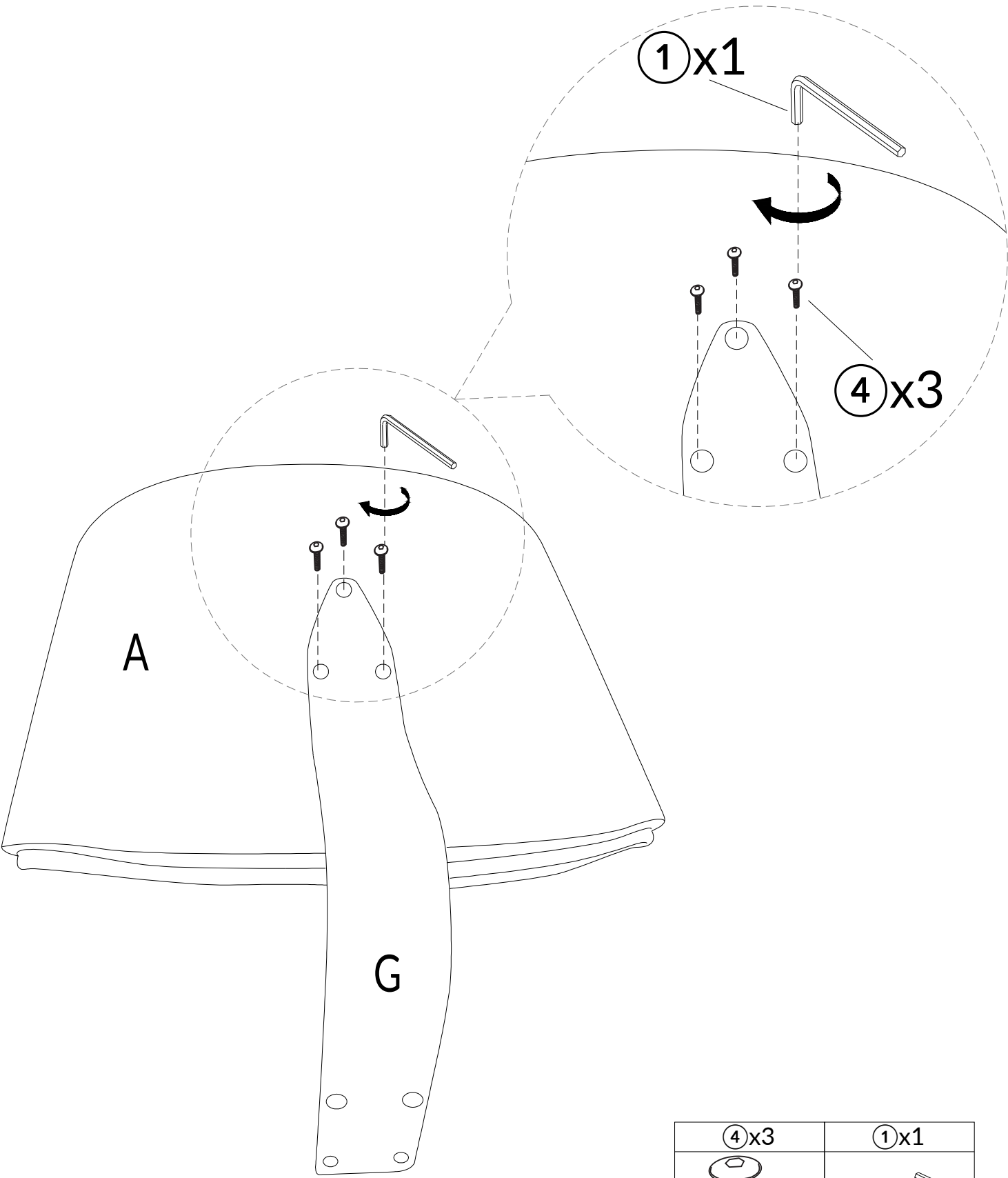

①x1

④x3

A

G

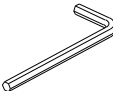
④x3	①x1
	
M6*25MM	

Step 4

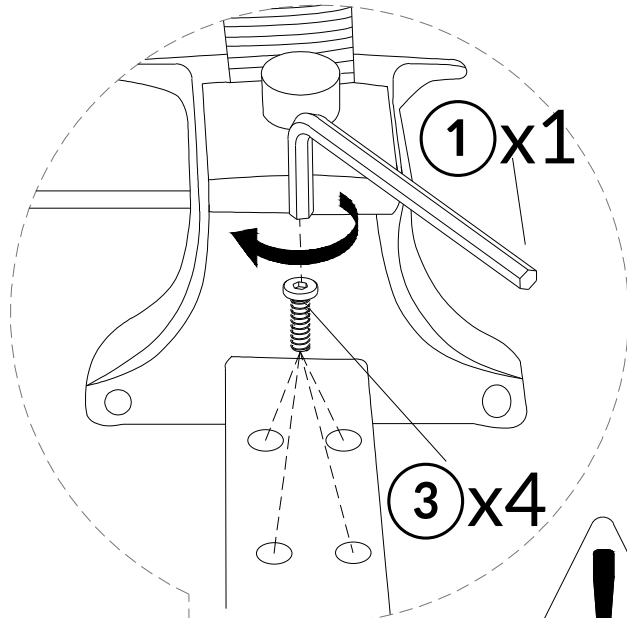

!
The connecting rod (G) is installed above the regulator (C).

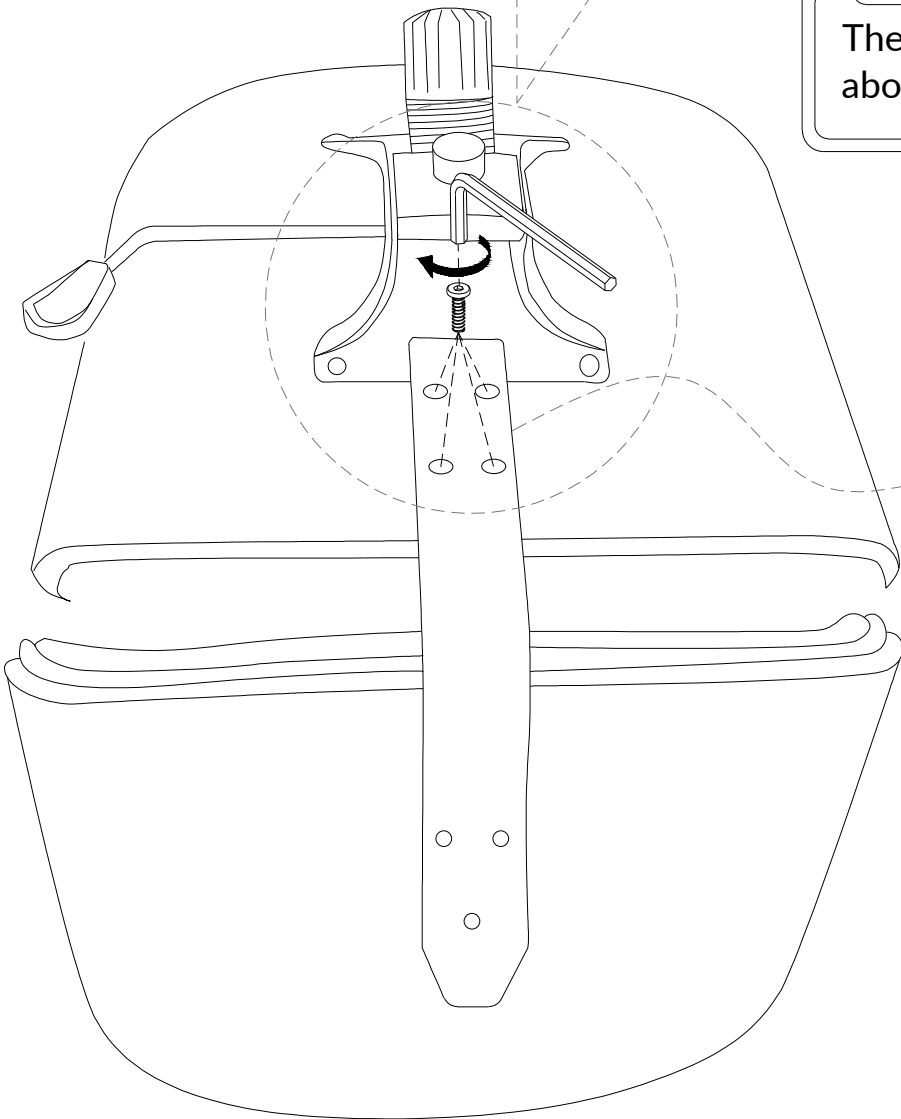
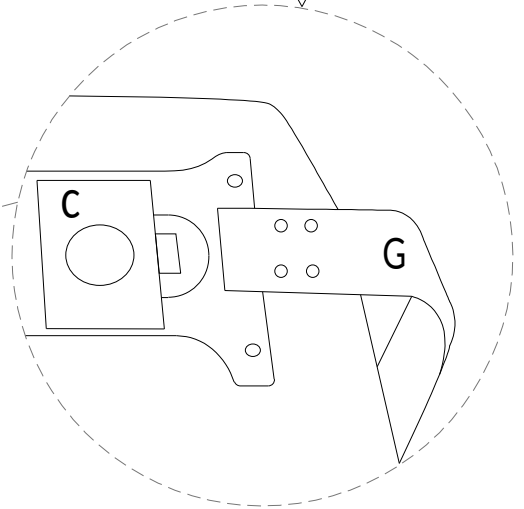

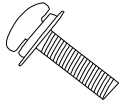
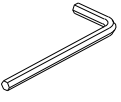
3×4	1×1
	
M6*30MM	

Step 5

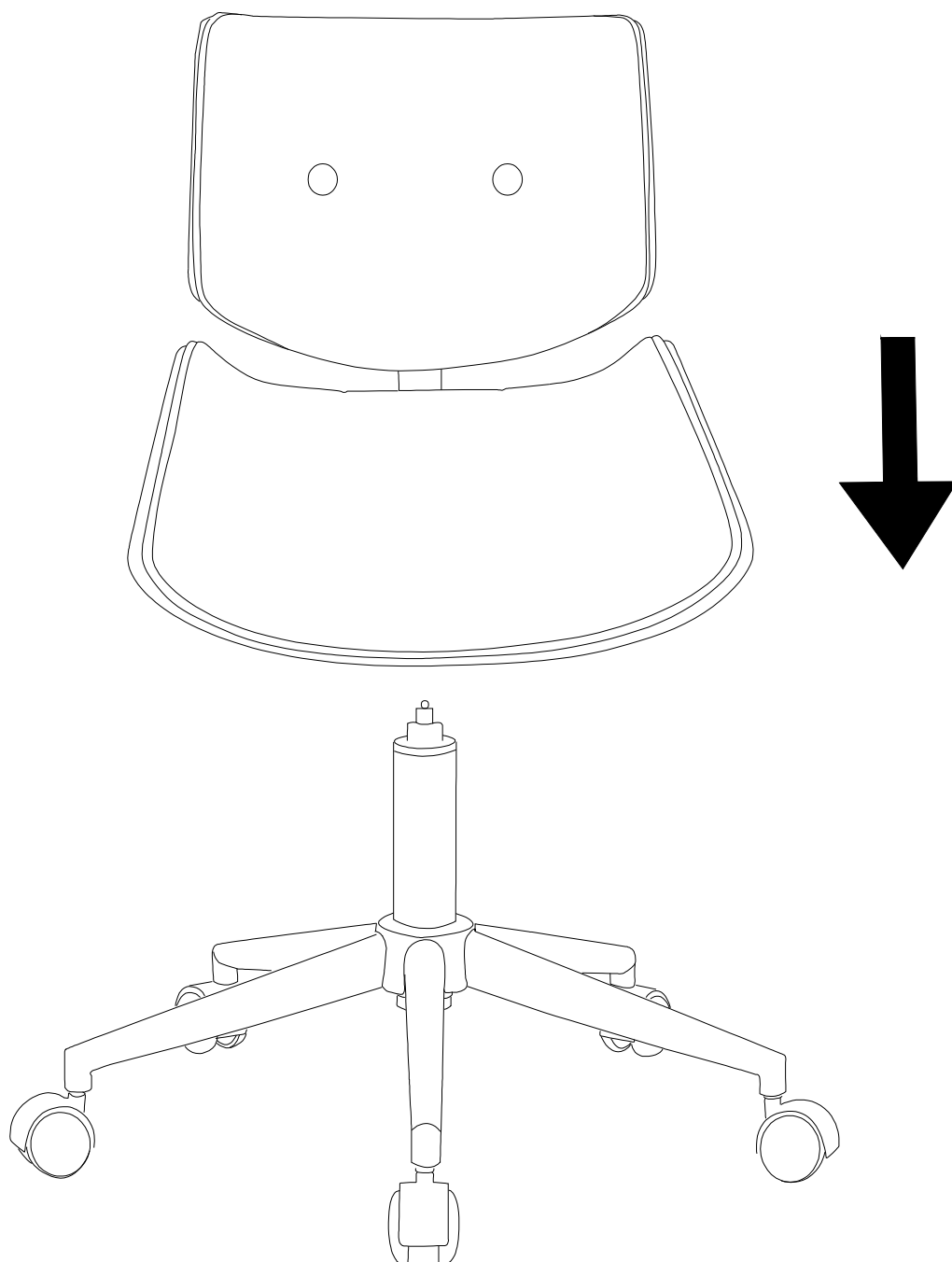

Step 6

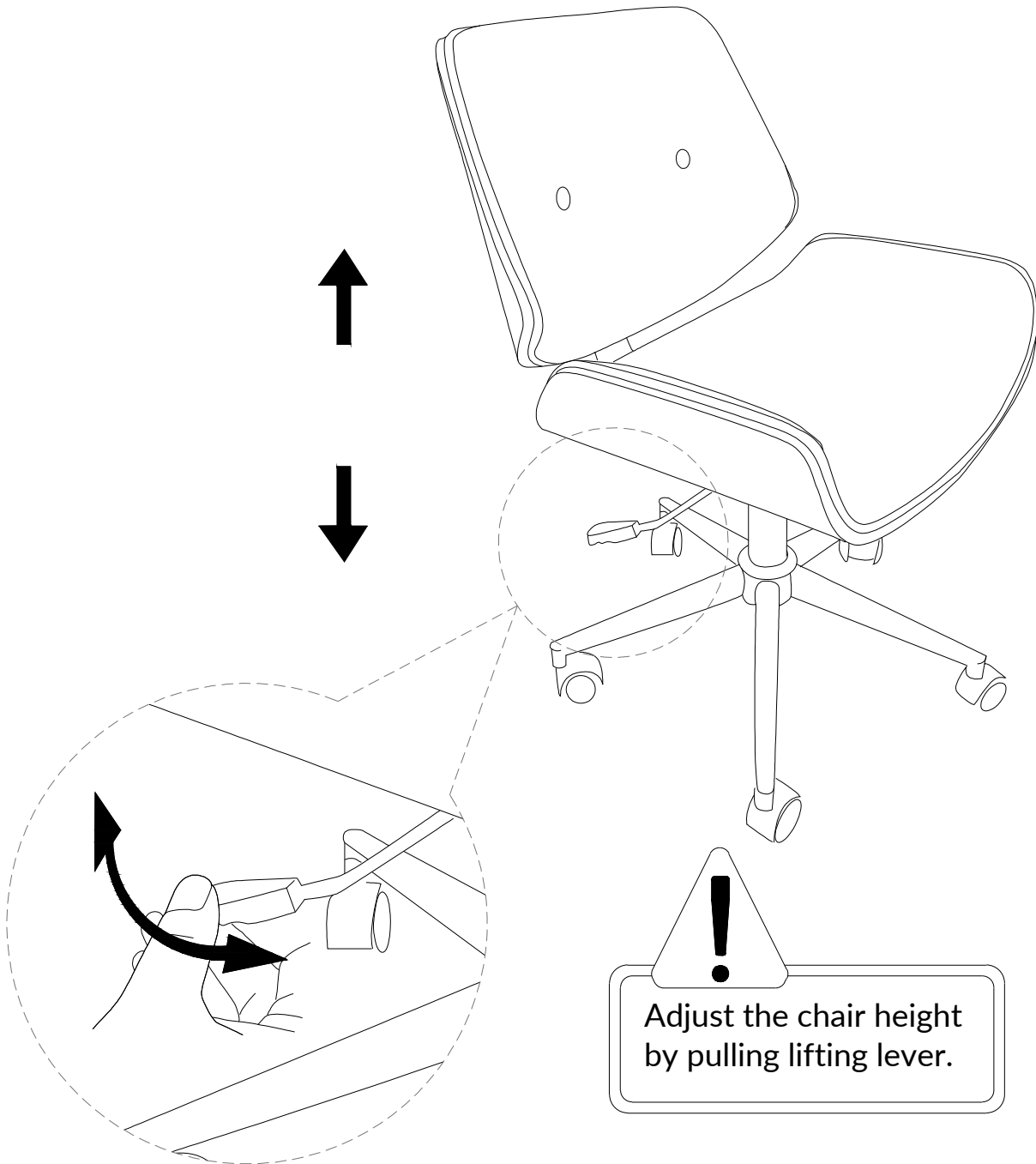

Step 7

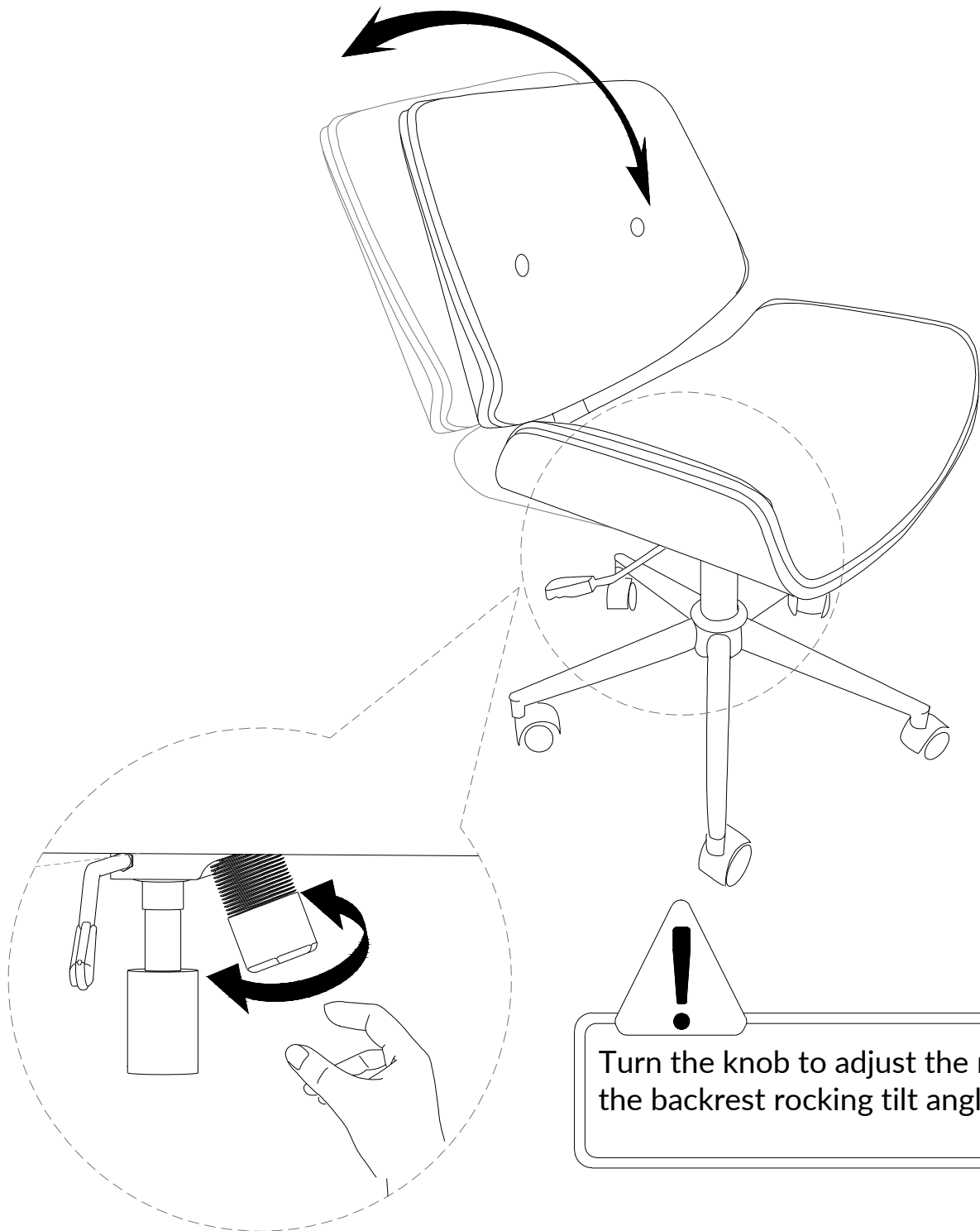

Step 8

