

# IMPORTANT INSTRUCTIONS & OPERATING MANUAL

**Model#:EFW-HT48FC1 / EFW-HT54FC1 / EFW-HT70FC1**

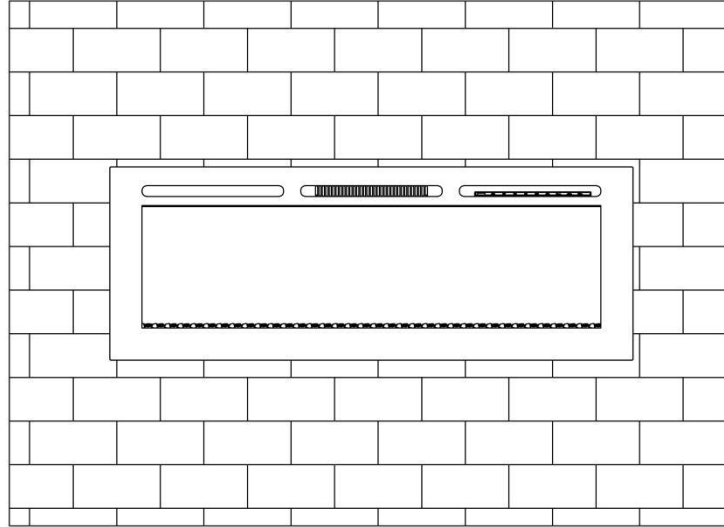

Wall mounted / Wall recessed

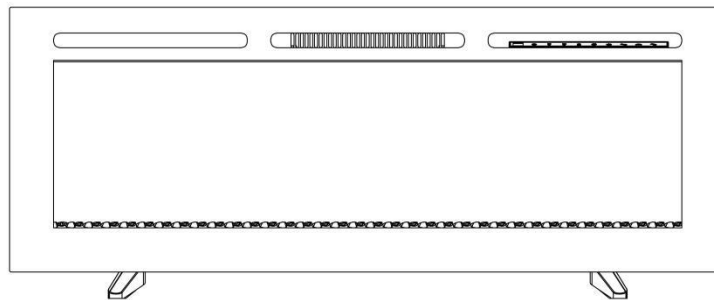

Free standing

## **⚠ WARNING**

**Read and understand** this entire owner's manual, including **all safety information**, before plugging in or **using** this product. Failure to do so could result in **fire, electric shock, or serious personal injury**.

## **⚠ CAUTION**

**Keep this owner's manual** for future reference. If you sell or give this product away, **make sure this manual accompanies this product**.

**NO VENTIN GREQUIRED**  
**120V AC; 60 Hz; 1500 Watts**

# CONTENTS

Important Information.....	1
Packing List.....	2
Specification.....	3
Installation.....	3
Heater Rating.....	9
Operation.....	9
Remote Control Battery Information .....	12
Temperature Limiting Control.....	12
Care and Maintenance.....	12
Safety Instructions .....	13
Trouble shooting .....	14
Limited Warranty .....	15



**IMPORTANT:** It is important to read these instructions carefully before using the appliance for the first time. Keep the instructions safe so that you can refer to them later if necessary.

## 【 Important Information 】

When using electrical appliances basic precautions should always be followed to reduce the risk of fire, electric shock and injury to persons, including the following:

**Read all instructions before using this heater.**

- 1) This heater is hot when in use. To avoid burning, do not touch hot surface. If provided, use handles when moving this heater. Keep combustible materials, such as furniture, pillows, bedding, papers, clothes, and curtains at least 1 m from the front of the heater and keep them away from the sides and rear. In order to avoid overheating, do not cover the heater.
- 2) Extreme caution is necessary when any heater is used near children or the infirm and whenever the heater is left operating and unattended.
- 3) Always unplug heater when not in use.
- 4) Do not operate any heater with a damaged cord or plug or after the heater malfunctions, has been dropped or damaged in any manner, return heater to authorized service facility for examination, electrical or mechanical adjustment, or repair.
- 5) Do not use outdoors.
- 6) This heater is not intended for use in bathrooms, laundry areas and similar indoor locations. Never locate heater where it may fall into a bathtub or other water container.
- 7) Do not run cord under carpeting. Do not cover cord with throw rugs, runners, or similar coverings. Arrange cord away from traffic area and where it will not be tipped over.
- 8) To disconnect heater, turn controls to off, then remove plug from outlet.
- 9) Do not inset or allow foreign objects to enter any ventilation or exhaust opening as this may cause an electric shock or fire, or damage the heater.
- 10) To prevent a possible fire, do not block air intakes or exhaust in any manner. Do not use on softsurfaces, like a bed, where openings may become blocked.
- 11) A heater has hot and arcing or sparking parts inside. Do not use it in areas where gasoline, orflammable liquids are used or stored.
- 12) Use this heater only as describes in this manual. Any other use not recommended by the manufacturer may cause fire, electric shock, or injury to persons.
- 13) DANGER-HIGH Temperatures may be generated under certain abnormal conditions. Do not partially or fully cover or obstruct the front of this heater.
- 14) Replacement of the lamps should be done only while the heater is disconnected from the supplycircuit.
- 15) This appliance is not intended for use by persons (including children) with reduced physical, sensory or capabilities, or lack of experience and knowledge, unless they have been given supervision or instruction concerning use of the appliance by a person responsible for their safety.
- 16) Children should be supervised to ensure that they do not play with the appliance.
- 17) CAUTION: In order to avoid a hazard due to inadvertent resetting of the thermal cut-out, this appliance must not be supplied through an external switching device, such as a timer, or connected to a circuit that is regularly switched on and off by the utility.

## ● Unpacking And Testing Appliance

Remove all parts and hardware from the carton and place them on a clean, soft, dry surface. Check the parts list to make sure no parts are missing. If parts are missing, please contact technical support for replacement. Prior to installing the appliance, test to make sure the appliance operates properly by plugging the power supply cord into a conveniently located 110-120 Volt grounded outlet.

**NOTE:** Dispose of plastic bag, as it may cause choking hazard with young children. Do not let children play with plastic bag.







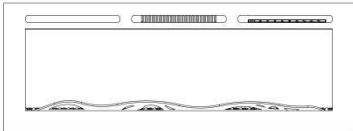

## ● Grounding Appliance

This appliance is for use on 120 Volts. For connecting three-blade grounding type plugs to three -slot receptacles. The green grounding lug extending from the adapter must be connected to a permanent ground such as a properly grounded outlet box. The adapter should not be used if a three-slot grounded receptacle is available. To disconnect appliance, turn controls off, then remove the plug from outlet.

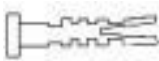
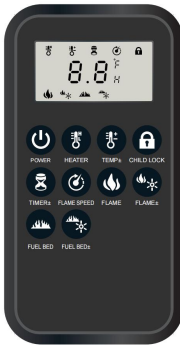
### WARNING:

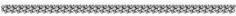
Keep the front of the appliance through which the heat is radiated at least 1 meter away from furniture, curtains and other flammable objects at all time. Never use an extension lead. The main cable must remain at the back of the appliance and must not be in contact with any hot elements.

## 【 Packing List 】

PARTS AND HARDWARE			
 <p>Fireplace(A)</p>	 <p>7-Screws(B)</p>	 <p>7-Drywall Anchors(C)</p>	 <p>Remote Control</p>
	 <p>7-Metal Washers(D)</p>	 <p>4-M6x12 Bolts(E)</p>	
 <p>Decorative Crystals(F)</p>	 <p>2-Foot Brackets(G)</p>		
 <p>Log (H)</p>	 <p>Log set(I)</p>		

## 【 Specification 】

Model	EFW-HT48FC1/EFW-HT54FC1/EFW-HT70FC1
Power supply	120V-60Hz
Amps	15
Power consumption	Max1500
Light bulb	LED
Cord length	6 ft

## 【 Installation 】

WARNING: Find a safe location and build a suitable hole for fireplace. Minimum clearance from the ceiling and the mantel must be at least 8 inches (200mm); minimum clearance from the front must be at least 3 feet (900mm). Choose a location near an outlet so an extension cord is not required.

### Dimension

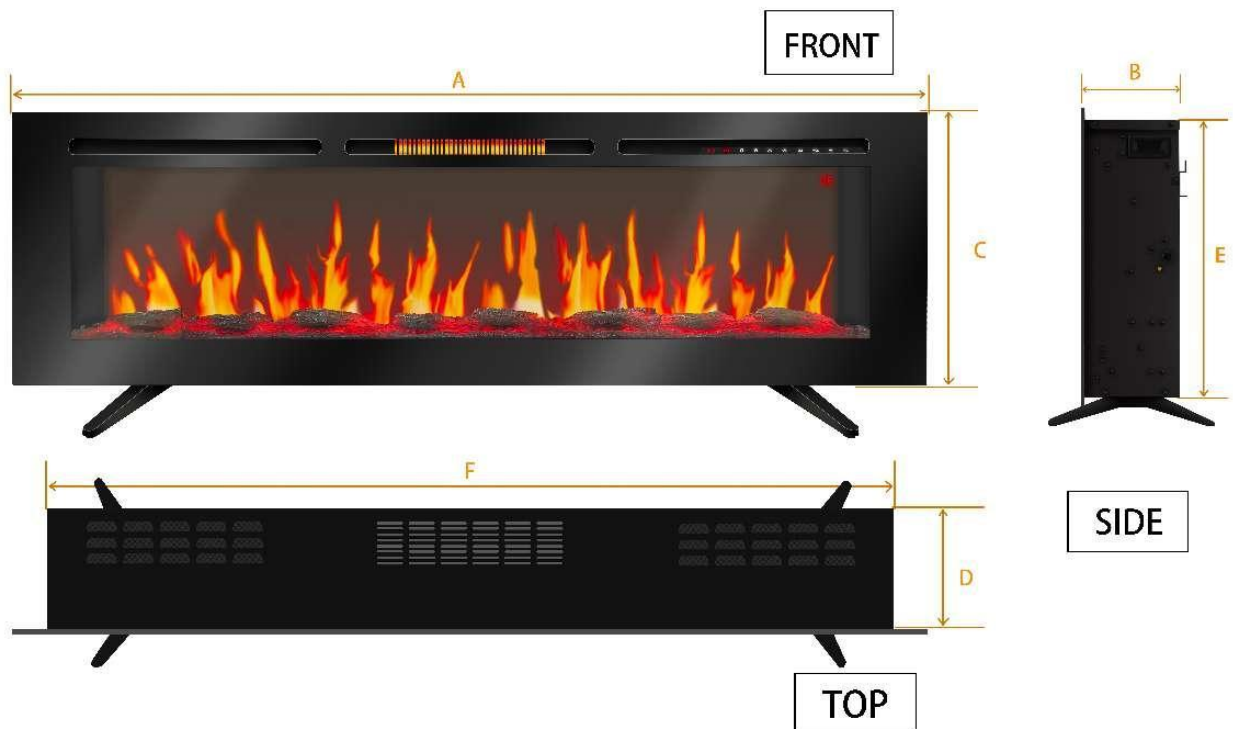

MODEL	EFW-HT48FC1	EFW-HT54FC1	EFW-HT70FC1
A(Inch)	48"(1220mm)	53.94"(1370mm)	70"(1780mm)
B(Inch)	5.3"(135mm)	5.3"(135mm)	5.3"(135mm)
C(Inch)	17.7"(450mm)	17.7"(450mm)	17.7"(450mm)
D(Inch)	5.1"(130mm)	5.1"(130mm)	5.1"(130mm)
E(Inch)	15.7"(399.4mm)	15.7"(399.4mm)	15.7"(399.4mm)
F(Inch)	43.92"(1115.6mm)	49.83"(1265.6mm)	65.97"(1675.6mm)

- ⚠ Before installing the in-wall fireplace, please read the following steps carefully.**
- ⚠ ALWAYS unplug this fireplace heater before assembly, cleaning, or relocating. Failure to do so could result in electric shock, fire, or personal injury.**

### Recessed Fireplace Style

STEP 1: Have two competent adults hold the front glass panel and use a screwdriver to remove the two screws in the top corner of the fireplace (keep the removed screws in place). Lift the glass and remove the two hooks in the bottom corner. Together, carefully remove the front glass plate and place it on a clean, soft surface. Remove the two pieces of pearl cotton and the charcoal fire that are supported inside, and remove the protective film of the back plate.

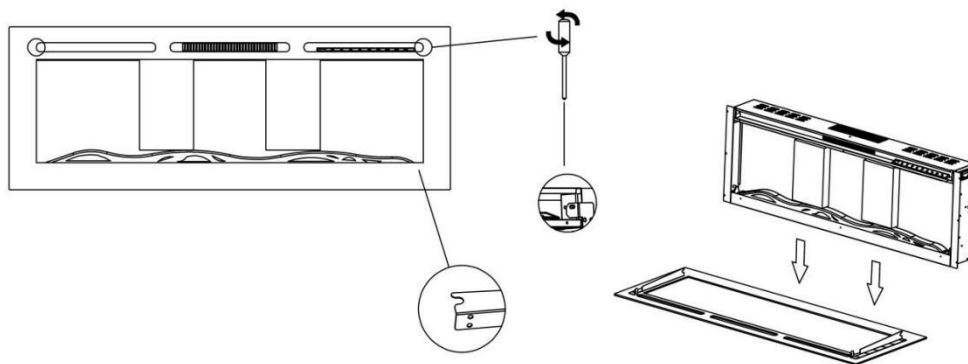

STEP 2: Select a dry wall, open a hole for fireplace box. Size of the hole as below:

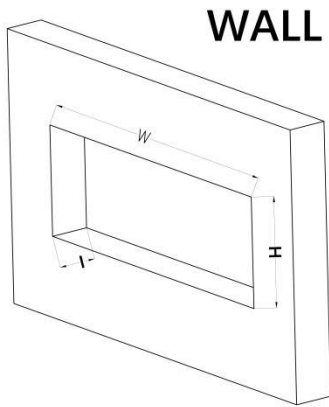

Hole size			
Model Number	w	H	l
EFW-HT48FC1	44.88"(1140mm)	16.14" (410mm)	5.79"(147mm)
EFW-HT54FC1	50.79"(1290mm)	16.14" (410mm)	5.79"(147mm)
EFW-HT70FC1	66.93"(1700mm)	16.14" (410mm)	5.79"(147mm)

STEP 3: Punch 6 holes in the wall and install 6 Drywall anchors (C), please drive the anchors completely into the wall. **Note: Make sure the holes in the wall are aligned with the holes in the electric fireplace.**

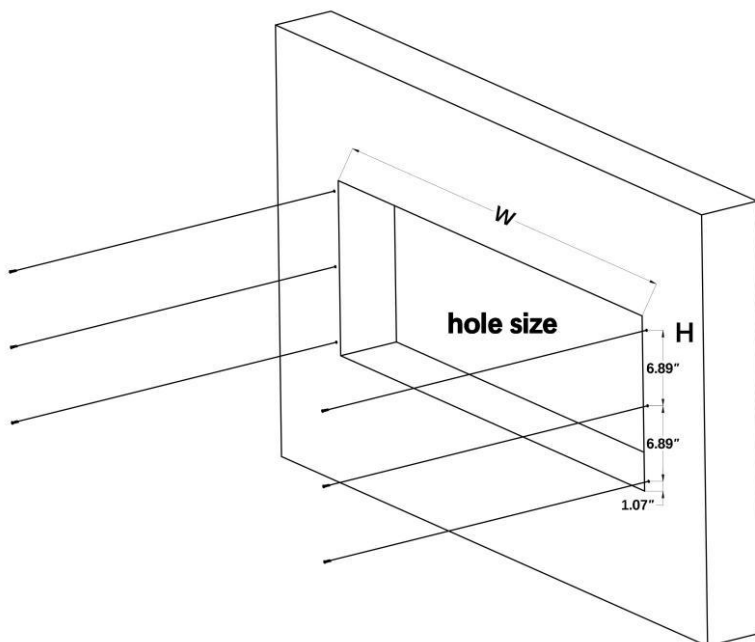
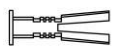

STEP 4: Fit the fireplace (without front panel) into the hole in wall. Make sure the appliance is fully recessed into the wall, then use 6 screws (B) and 6 metal washers (D) to lock the appliance into wall.

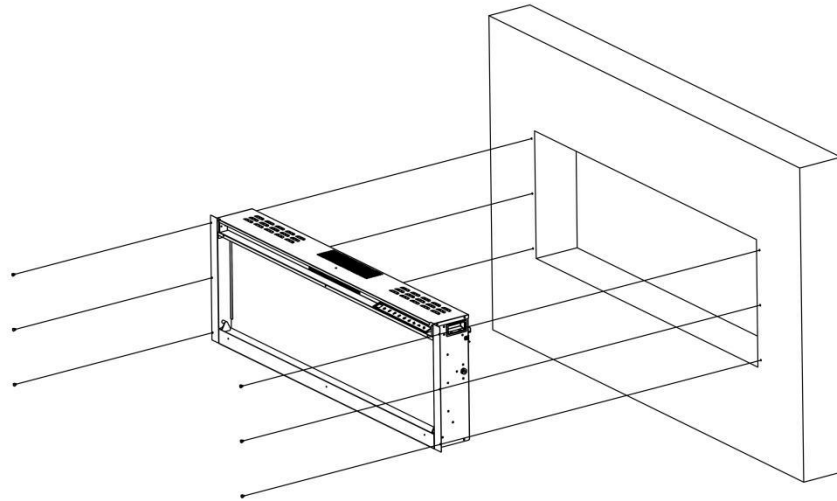

STEP 5: Install the media (decorative crystals/Log/Log set) into place.

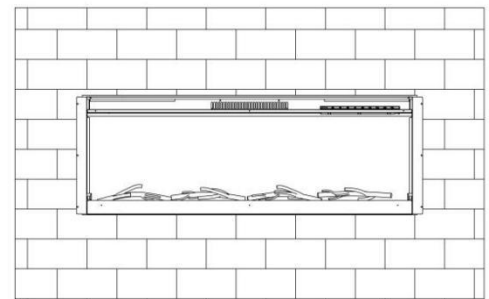
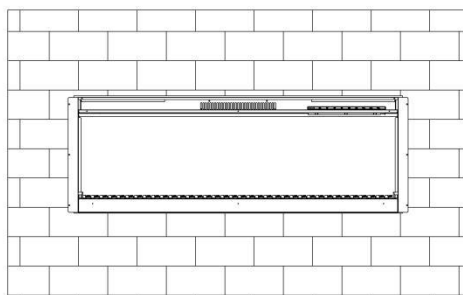
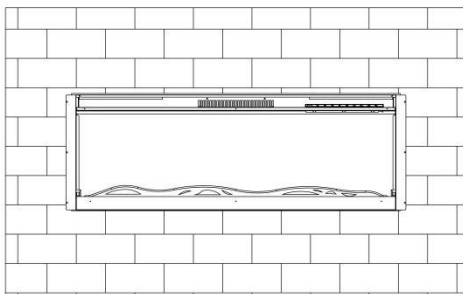

STEP 6: Re-install the front panel by two capable adults, hook the two clips on both bottom corners of the fireplace, then tighten the two screws on both top corners.

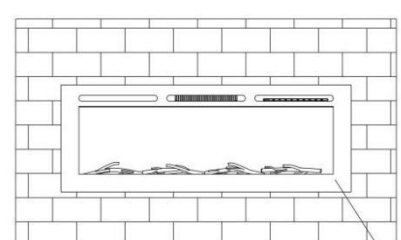
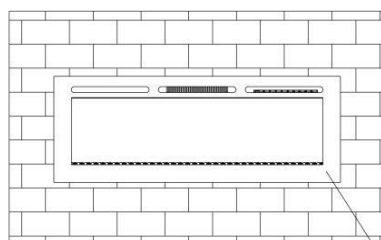
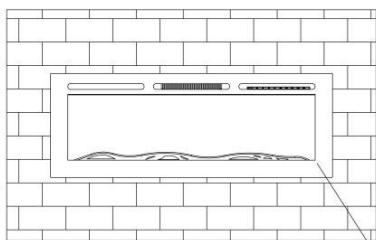

## Wall-Mounted Fireplace Style



This next step involves GLASS! ALWAYS Use extreme caution when handling glass. Failure to do So could result in personal injury or property damage.

Due to various types of walls, it is highly recommended that you consult your local builder before you install this appliance on the wall.

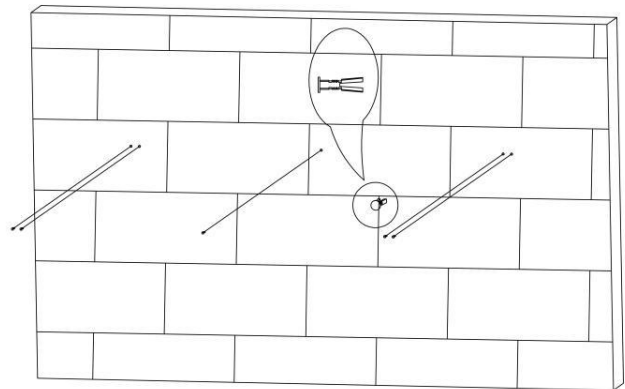
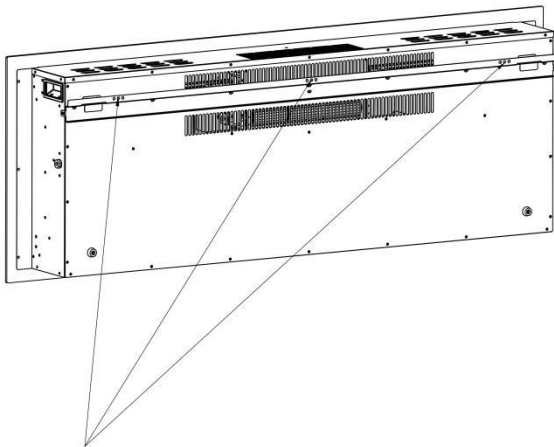

1. Untighten the three screws here and remove the hanging bar.

2. Install 5 drywall anchors (C) completely into wall and make sure they are on a horizontal line.

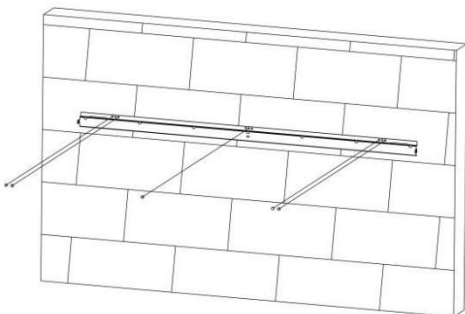

3. Install the hanging bar onto wall by using 5 screws (B) and 5 metal washers (D). Ensure hanging bar level. Screw them in completely.

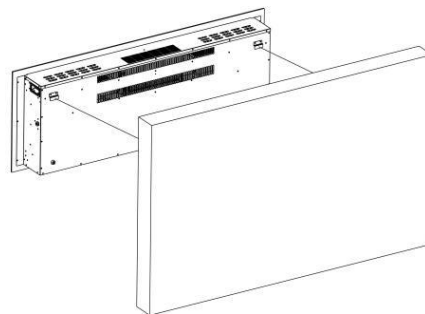

4. Have two capable adults lift the fireplace and hang it on. Make sure both ends are secured.

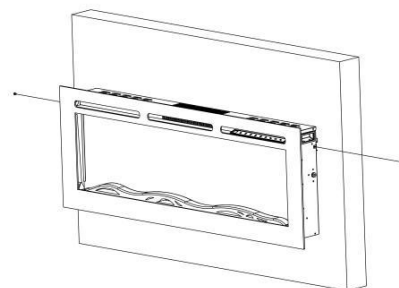

5. Make sure the electric fireplace is in a level line.

## Foot Assembly For Free Standing Option

STEP 1: With the help of a capable adult, carefully lay the fireplace on a protected work surface.

STEP 2: Secure the Foot Bracket(G) to the bottom of the fireplace with two M6x12 Bolts(E) .Tighten each screw securely with a screwdriver.Repeat the steps to install another Foot Bracket(G).

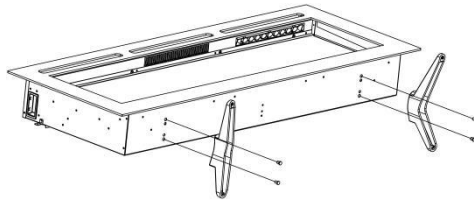

STEP 3: Remove the two screws in the top corner of the fireplace with a screwdriver, and two competent adults lift the glass and remove the two hooks in the bottom corner. Together, carefully remove the front glass plate and place it on a clean, soft surface.

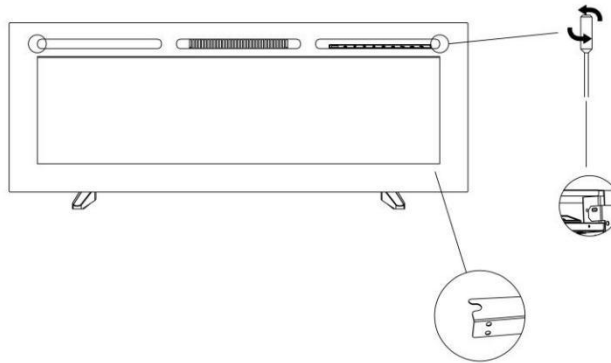

STEP 4: Install the media (decorative crystals/Log/Log set) into place.

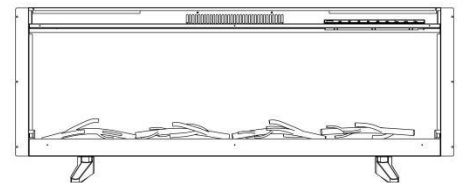
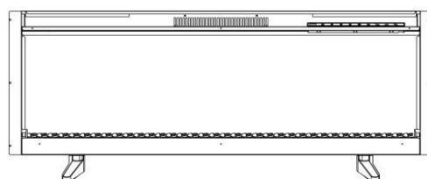
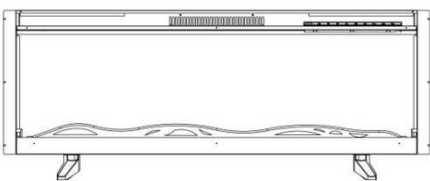

STEP 5: Re-install the front panel by two capable adults, hook the two clips on both bottom corners of the fireplace, then tighten the two screws on both top corners.

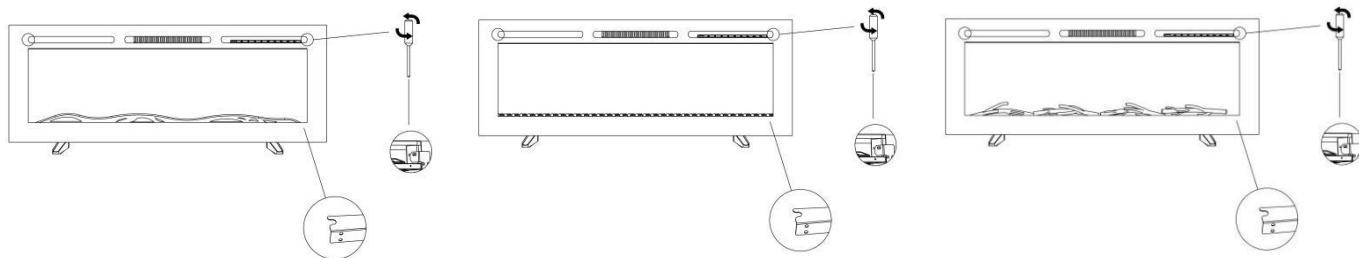

## 【 Heater Rating 】

Maximum heat output: 1500W (5120BTU);

Maximum heating area: 400 square feet.

## 【 Operation 】









Read and understand this entire owner's manual, including all safety information, before plugging in or using this product. Failure to do so could result in electric shock, fire, serious injury, or death.

### POWER

Plug the power cord into a 110-120 Volt 15 Amp outlet. Make sure the outlet is in good condition and that the plug is not loose. NEVER exceed the maximum amperage for the circuit. DO NOT plug other appliances into the same circuit.

## Control Panel Functions

**NOTICE** When the heat function is used for the first time, a slight odor may be present. This is normal and should not occur again unless the heater is not used for an extended period of time.

CONTROLS		FUNCTION																																																						
	<b>POWER</b>	<p><b>Press ON.</b>Power turns ON. All functions are enabled.</p> <p><b>Press OFF.</b>Power, flame effect, and all functions turn off.</p>																																																						
	<b>HEATER</b>	Press to turn the heater on.'LL' indicates low with 750 Watt applied; 'HH' indicates high with 1500 Watt applied; '- -' indicates heater is off.																																																						
	<b>TEMP(+/-)</b>	<p>1.Press once: Touch panel indicator becomes active.</p> <p>2.Press the button for 10 seconds, the temperature setting will switch from °C to °F. Same way from °F to °C.</p> <table border="1"> <tr> <td></td> <td>1</td><td>2</td><td>3</td><td>4</td><td>5</td><td>6</td><td>7</td><td>8</td><td>9</td><td>10</td><td>11</td><td>12</td><td>13</td><td>14</td><td>15</td><td>16</td><td>17</td> </tr> <tr> <td>°C</td> <td>17</td><td>18</td><td>19</td><td>20</td><td>21</td><td>22</td><td>23</td><td>24</td><td>25</td><td>26</td><td>27</td><td>28</td><td>29</td><td>30</td><td>32</td><td>34</td><td>37</td> </tr> <tr> <td>°F</td> <td>62</td><td>64</td><td>66</td><td>68</td><td>69</td><td>71</td><td>73</td><td>75</td><td>77</td><td>78</td><td>80</td><td>82</td><td>84</td><td>86</td><td>89</td><td>93</td><td>99</td> </tr> </table>		1	2	3	4	5	6	7	8	9	10	11	12	13	14	15	16	17	°C	17	18	19	20	21	22	23	24	25	26	27	28	29	30	32	34	37	°F	62	64	66	68	69	71	73	75	77	78	80	82	84	86	89	93	99
	1	2	3	4	5	6	7	8	9	10	11	12	13	14	15	16	17																																							
°C	17	18	19	20	21	22	23	24	25	26	27	28	29	30	32	34	37																																							
°F	62	64	66	68	69	71	73	75	77	78	80	82	84	86	89	93	99																																							
	<b>TIMER(+/-)</b>	This fireplace is equipped with a timer ranging from 1hr to 9hrs(0H,1H,2H...9H,Off shown on the LCD display),touch the button once for every 1hr increase.																																																						
	<b>FLAME SPEED</b>	Use this button to adjust flame speed from 1(min.) to 3(max.)																																																						
	<b>FLAME</b>	Use this button to desire flame color, 14 options indicate:0-Flame off, 1-6 for solid colors, 7-14 for mixed colors.																																																						
	<b>FLAME(+/-)</b>	Press Flame (+) Button to desired flame brightness.6options indicate: 1-6(Low-High).																																																						
	<b>FUEL BED</b>	Use this button to desire fuel bed color, 14 options indicate.0-Fuel bed off.																																																						

	<p><b>FUEL BED(+/-)</b></p>	<p>Use this button to desire Media bed brightness level, options indicate: 1-6(Low-High).</p>
---	-----------------------------	---

# Remote Control Functions

**NOTICE** Control panel Power Switch must be ON to use remote control. Aim the remote control at the remote receiver. Make sure you hear a beep each time you press the button! If not, the fireplace will not respond to the signal.

REMOTE CONTROL BUTTONS		FUNCTION																																																						
	<p><b>POWER</b></p>	<p><b>Press ON.</b>Power turns ON. All functions are enabled. <b>Press OFF.</b>Power, flame effect, and all functions turn off.</p>																																																						
	<p><b>HEATER</b></p>	<p>Press to turn the heater on.'LL' indicates low with 750 Watt applied; 'HH' indicates high with 1500 Watt applied; '-- ' indicates heater is off.</p>																																																						
	<p><b>TEMP(+/-)</b></p>	<p>1.Press once: Touch panel indicator becomes active. 2.Press the button for 10 seconds, the temperature setting will switch from °C to ° F. Same way from °F to °C.</p> <table border="1" data-bbox="608 1104 1552 1211"> <tr> <td></td> <td>1</td><td>2</td><td>3</td><td>4</td><td>5</td><td>6</td><td>7</td><td>8</td><td>9</td><td>10</td><td>11</td><td>12</td><td>13</td><td>14</td><td>15</td><td>16</td><td>17</td> </tr> <tr> <td>°C</td> <td>17</td><td>18</td><td>19</td><td>20</td><td>21</td><td>22</td><td>23</td><td>24</td><td>25</td><td>26</td><td>27</td><td>28</td><td>29</td><td>30</td><td>32</td><td>34</td><td>37</td> </tr> <tr> <td>°F</td> <td>62</td><td>64</td><td>66</td><td>68</td><td>69</td><td>71</td><td>73</td><td>75</td><td>77</td><td>78</td><td>80</td><td>82</td><td>84</td><td>86</td><td>89</td><td>93</td><td>99</td> </tr> </table>		1	2	3	4	5	6	7	8	9	10	11	12	13	14	15	16	17	°C	17	18	19	20	21	22	23	24	25	26	27	28	29	30	32	34	37	°F	62	64	66	68	69	71	73	75	77	78	80	82	84	86	89	93	99
		1	2	3	4	5	6	7	8	9	10	11	12	13	14	15	16	17																																						
	°C	17	18	19	20	21	22	23	24	25	26	27	28	29	30	32	34	37																																						
	°F	62	64	66	68	69	71	73	75	77	78	80	82	84	86	89	93	99																																						
	<p><b>TIMER(+/-)</b></p>	<p>This fireplace is equipped with a timer ranging from 1hr to 9hrs(0H,1H,2H...9H,Off shown on the LCD display),touch the button once for every 1hr increase.</p>																																																						
	<p><b>CHILD LOCK</b></p>	<p>Long press for 10 seconds, the display will appear a lock sign, the function key on the remote control will be disabled. After pressing and holding again for 10 seconds, the locked icon disappears and the remote control can control the fireplace normally. (The control panel still works while the remote is locked)</p>																																																						
	<p><b>FLAME SPEED</b></p>	<p>Use this button to adjust flame speed from 1(min.) to 3(max.)</p>																																																						
<p><b>FLAME</b></p>	<p>Use this button to desire flame color, 14 options indicate:0-Flame off, 1-4 for solid colors, 5-14 for mixed colors.</p>																																																							
<p><b>FLAME(+/-)</b></p>	<p>Press Flame (+) Button to desired flame brightness.6options indicate: 1-6(Low-High).</p>																																																							
<p><b>FUEL BED</b></p>	<p>Use this button to desire fuel bed color, 14 options indicate.0-Fuel bed off.</p>																																																							

	<b>FUEL BED(+/-)</b>	Use this button to desire Media bed brightness level, options indicate: 1-6(Low-High).
--	--------------------------	--

## 【 Remote Control Battery Information 】

- This remote control uses Two AAA7#battery (not included).
- Instructions for battery installation are on the Remote control Battery compartment.



### NOTICE

The remote control not include the batteries. Do not mix old and new batteries. Do not mix alkaline, standard(carbon zinc), or rechargeable(nicad, nimh, ect.) batteries.

### NOTICE

NEVER dispose of batteries in fire. Failure to observe this precaution may result in an explosion. Dispose of batteries at your local hazardous material processing center.

## 【 Temperature Limiting Control 】

This heater is equipped with a Temperature Limiting Control. Should the heater reach an unsafe temperature, the heater will automatically turn OFF.

To reset:

1. Unplug the power cord from the outlet.
2. Turn the ON/OFF switch on the **CONTROL PANEL to OFF**. Wait 5 minutes.
3. Inspect the fireplace to make sure no vents are blocked, or clogged with dust or lint. If they are, use a vacuum to clean the vent areas.
4. With the POWER switch in the OFF position, plug the power cord back into the outlet.
5. If the problem continues, have your outlet and wiring inspected by a professional.

## 【 Care and Maintenance 】

## NOTICE

Always turn the heater OFF and unplug the power cord from the outlet before cleaning , performing maintenance , or moving this fireplace. Failure to do So could result in electric shock fire or personal injury.

## NOTICE

NEVER immerse in water or spray with water or other liquids (ex: cleaning solutions) . Doing So could result in electric shock, fire, or personal injury.

## CLEANING

### Metal:

- Dust using a brush or lint-free cloth , slightly dampened with a citrus oil-based product. DO NOT Use brass polish or household cleaners as these will damage the metal.

### Glass:

- Spray glass cleaner onto soft cloth (NOT directly on to glass) . Dry thoroughly with a paper towel or lint-free cloth.
- NEVER Use abrasive cleansers or any cleaner that could scratch the surface.

### Plastic:

- Wipe with a slightly damp cloth and a mild solution of dish soap and warm water, Dry off surface.

### Vents:

- Use a vacuum or duster to remove dust and dirt from the heater and vent areas as needed.

## Maintenance

- After installation, the power plug should be accessible.
- The heater must not be located immediately below a socket.
- The appliance is not intended for use by young children or infirm persons. Young children should be supervised to ensure that they do not play with the appliance.
- In order to avoid overheating, do not cover the heater.
- Electrical and Moving Parts:The fan motors are lubricated at the factory and will not require lubrication. Electrical components are integrated in the fireplace and are not serviceable by the customer.
- Storage:Store fireplace in a clean, dry place when not in use.

## 【 Safety Instructions 】

- Only use the appliance in accordance with the instructions in this manual! It cannot be used for any other purpose.
- Never operate the appliance when the appliance itself or the main cable show any signs of damage. In order to avoid overheating, do not cover the heater.
- Be responsible when handling the packing material. Warning: plastic wrapping may be lethal to children. Do not place the appliance next to a socket.

- Never operate the heater on a program switch, timer switch or any other appliance for automatic operation.
- The heater is only suitable for indoor use.
- Never use the heater in the bathroom, shower or near a swimming pool. The heater must not be located immediately below a socket- outlet
- If the supply cord is damaged, it must be replaced by the manufacturer or its service agent or a similarly qualified person in order to avoid a hazard.
- Never leave small children unattended near the appliance. In case of malfunction, disconnect the plug immediately.
- When not in use for a considerable amount of time, unplug the appliance. Components should only be serviced by an approved electric technician.

## **【 Trouble shooting 】**

1.Q: Unit does not heat?

A: 1.Turn on the heater to see if the heater will work continuously.

2.If not, unplug the unit for a whole night. And then turn it on again.

3.If still not, contact service team for help

2.Q: Why is there no flame effect?

A:1. Make sure the unit is plugged into a power outlet.

2.Check if the main power on the right side of the fire place is turned on.

3.Switch the flame color by the remote or touch screen to check whether there is flame effect. 4.If still not, please contact service team for help.

3.Q: Fireplace turns off and will not turn on.

A: Fireplace has overheated and safety devise has caused thermal switch to disconnect or home circuit breaker has opened.Reset switch by turning main power off and waiting turning it back on or breaker circuit breaker.

4.Q: The remote does not work and the new unit cannot be turned on.

A: 1. Replace batteries in remote control.

2.Aim control at sensor located directly behind glass screen in center of unit just above logs.

3.Replace remote control and/or sensor.

5.Q: The front trim is out of shape, the remote is missed or the log is broken.

A: Please contact customer service for a replacement and instruction.

6.Q: There is a black tie inside the unit or there is a small spot on the glass.

A: Please contact customer service for an instruction of removing the glass.

7.Q:There is a noise only when the flame is on.

A:The spindle touches the wires or panels around, please contact customer service team for a checking instruction manual.

8.Q:The heater of my new product does not work.

1.There is no air blowing.

Check if the connector on the PCB board that links to the fan is loosen, if not, the problem might the PCB board.

2. There is only cold air.

The heating element might be broken. Please contact customer service team for help.

3. It blows a little heat and then shut off and never come back unless re-plug it.

The fan might be stuck or the heat motor is fall off. Confirm if there is something getting red inside the air outlet when turn the heater on, then contact customer service for help.

4. The blower works for about 5s then shuts off.

Press the temperature on the remote until there is no temp number showing on the

remote display to see if the blower will work. If not, check if the sensor is loosen, if yes, please kindly noted that there would be a 3 degree deviation between the temp the sensor feels and the room temperature.

## **【 Limited Warranty 】**

- This warrants to the original purchaser that this product is free from defects in material and workmanship as of the date of purchase and that it will, under normal use and proper care, remain so for one year from the date of purchase.
- Missing or initially defective parts will be replaced free of charge during the period of this limited warranty. If parts are unavailable, comparable replacement or refund will be given. The original dated sales receipt is required for all warranty claims.
- This warranty does not cover damage which has occurred during transport from the point of purchase to the consumer's home.
- This warranty does not cover glass, light bulbs, batteries, transportation, labor, or other issues not associated with the manufacture of the product.
- This product is for residential use only. Any and all commercial use of this product voids all warranties, and frees the manufacturer from all liability.
- Read and understand all assembly and operating instructions, and all safety information and warnings before use.
- The following will void this warranty: Damage caused from tampering with, modifying, or altering the fireplace insert in any manner; Damage due to incorrect assembly, improper care, misuse, or abuse; Damage from being used with the wrong power source; Water damage; Damage caused from this insert being used outdoors; Damage caused from this insert being used for excessive periods of time; Damage caused by the insert being used in a commercial application; Damage from use as a primary heat source; Other misuse or abuse not specifically listed herein.
- This product is not intended to be used as a primary heat source. It is for supplemental heating purposes only.

**Thank you for purchasing this product!**

For immediate help with assembly, product information or if your product arrives damaged, please contact us first. Our staff is ready to provide assistance.

**E-mail: [service@velayhome.com](mailto:service@velayhome.com)**

**Tel.: 1-302-281-1886**