

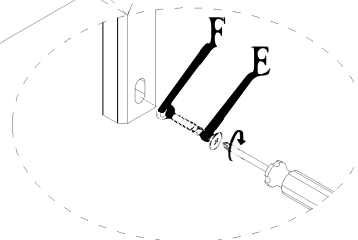

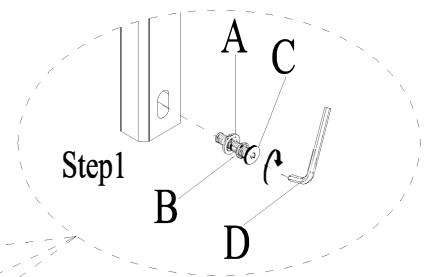

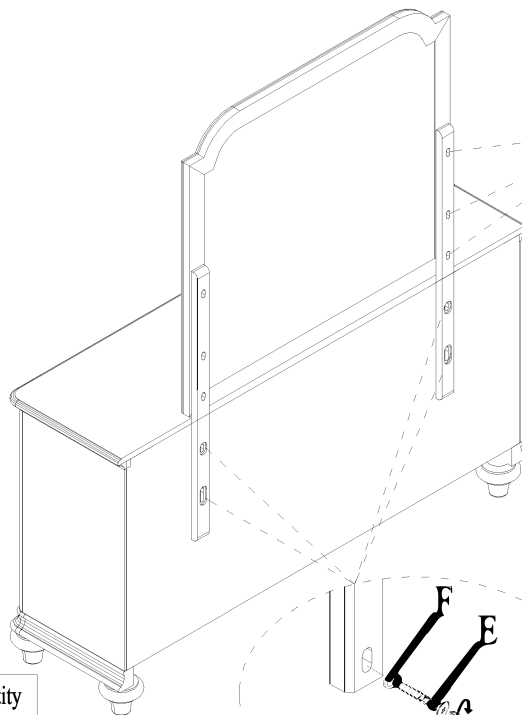
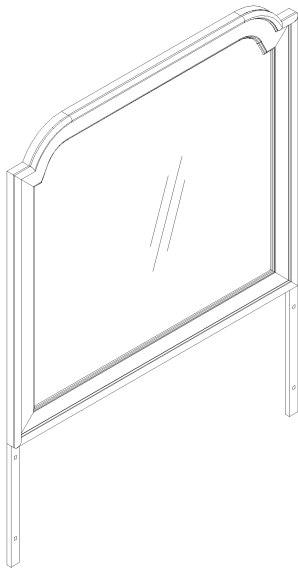

# ASSEMBLY INSTRUCTION

## 75-118 WESTLAND MIRROR

### IMPORTANT NOTES :

- . Place all wooden parts on a clean and smooth surface such as a rug or carpet to prevent the parts from being scratched.
- . Check to be sure that you have all parts and hardware.
- . Remove all wrapping materials, including staples and packing straps before you start to assemble.
- . Do not tighten all screws and bolts until completely assembled.
- . Keep all hardware out of the reach of children.



	Dimension	Shape	Quantity
A	flat washer #5/16"*19		10pcs
B	lock washer Ø5/16"		10pcs
C	bolt 5/16*35mm		10pcs
D	allen key 4mm		1pcs
E	Screw (#8*32mm)		4pcs
F	flat washer #1/4"*19		4pcs