

## CARE AND MAINTENANCE

Store outdoor furniture indoors or cover well when not in use.  
 Remove wicker furniture from standing water. Dust regularly with small brush or vacuum  
 Spills should be taken care of immediately before they harden or stain with a slightly dampened sponge.









## NOTICE

- \* Please make sure that you have all parts indicated before you begin assembly of this item
- \* This item should be assembled on a soft surface to prevent scratching the finish during assembly
- \* This item may require periodic tightening

**Weight Capacity : 275 Lbs (chair)  
 550 Lbs (bench)**

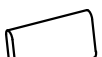
**Warning : Do not stand on corner  
 Warning : Do not over torque bolts/screws**

## Part List and Hardware List

PIECE	DESCRIPTION	PICTURE	QUANTITY
B	<b>Chair Leg - 1</b>		2X
G	<b>Corner Seat Frame</b>		1X
H	<b>Corner Right Seat Frame</b>		1X
I	<b>Corner Left Seat Frame</b>		1X
J	<b>Corner Seat Cushion</b>		3X
K	<b>Corner Back Long Cushion</b>		3X
L	<b>Corner Back Short Cushion</b>		1X
M	<b>Chair Leg - 2</b>		1X
HW1	<b>Socket Screws 6x0.5x15mm</b>		18X
HW2	<b>Allen key</b>		3X

Model# PAT7521 - 2/2  
 Product Dimensions:  
 23.62"x26.38"x29.13" H (Chair)  
 39.37"x25.59"x14.96" H (Table)  
 26.38"x26.38"x29.13" H (Corner)

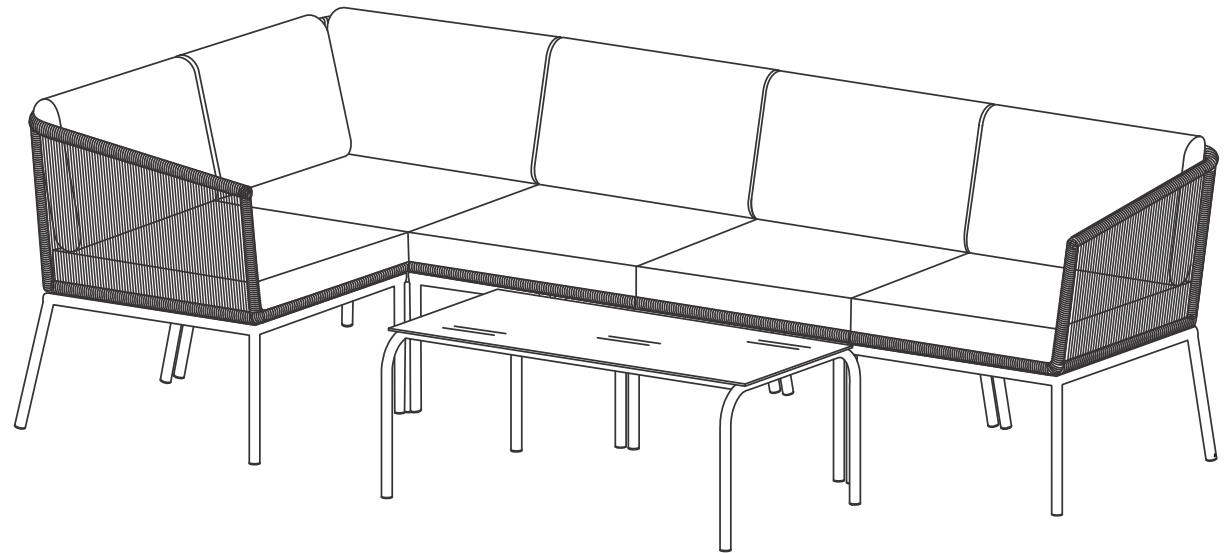

## CARE AND MAINTENANCE

Store outdoor furniture indoors or cover well when not in use.  
Remove wicker furniture from standing water. Dust regularly with small brush or vacuum  
Spills should be taken care of immediately before they harden or stain with a slightly dampened sponge.

## NOTICE

- \* Please make sure that you have all parts indicated before you begin assembly of this item
- \* This item should be assembled on a soft surface to prevent scratching the finish during assembly
- \* This item may require periodic tightening





**Weight Capacity : 275 Lbs (chair)  
550 Lbs (bench)**

**Warning : Do not stand on corner**

**Warning : Do not over torque bolts/screws**

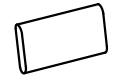

## Part List and Hardware List

PIECE	DESCRIPTION	PICTURE	QUANTITY
B	<b>Chair Leg - 1</b>		1X
I	<b>Corner Left Seat Frame</b>		1X
J	<b>Corner Seat Cushion</b>		1X
K	<b>Corner Back Long Cushion</b>		1X
HW1	<b>Socket Screws 6x0.5x15mm</b>		6X
HW2	<b>Allen key</b>		1X

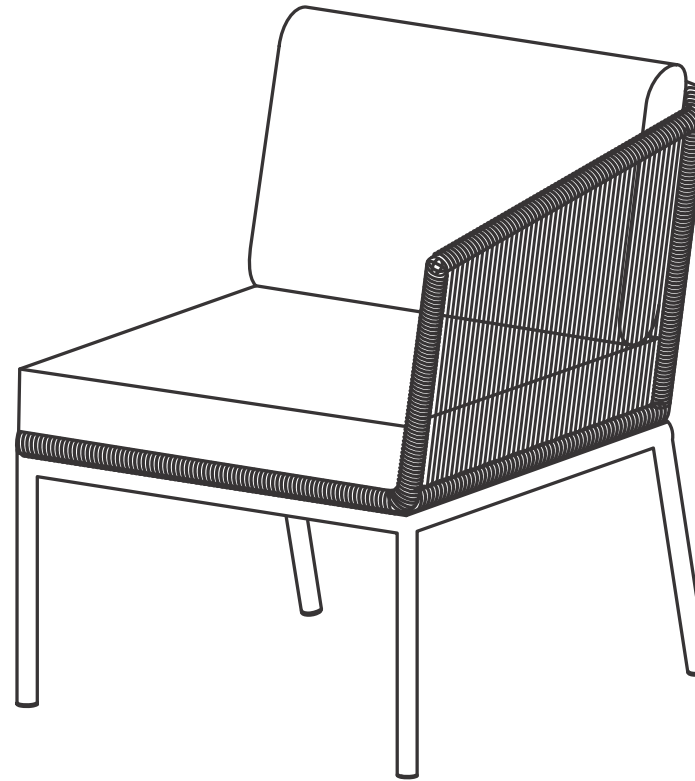

## PREPARATION

Before beginning assembly of product, make sure all parts are present. Compare parts with package contents list and hardware contents list.

If any part is missing or damaged, do not attempt to assemble the product.

Estimated Assembly Time: 15 minutes.

Tools Required for Assembly (included): Allen Key

1

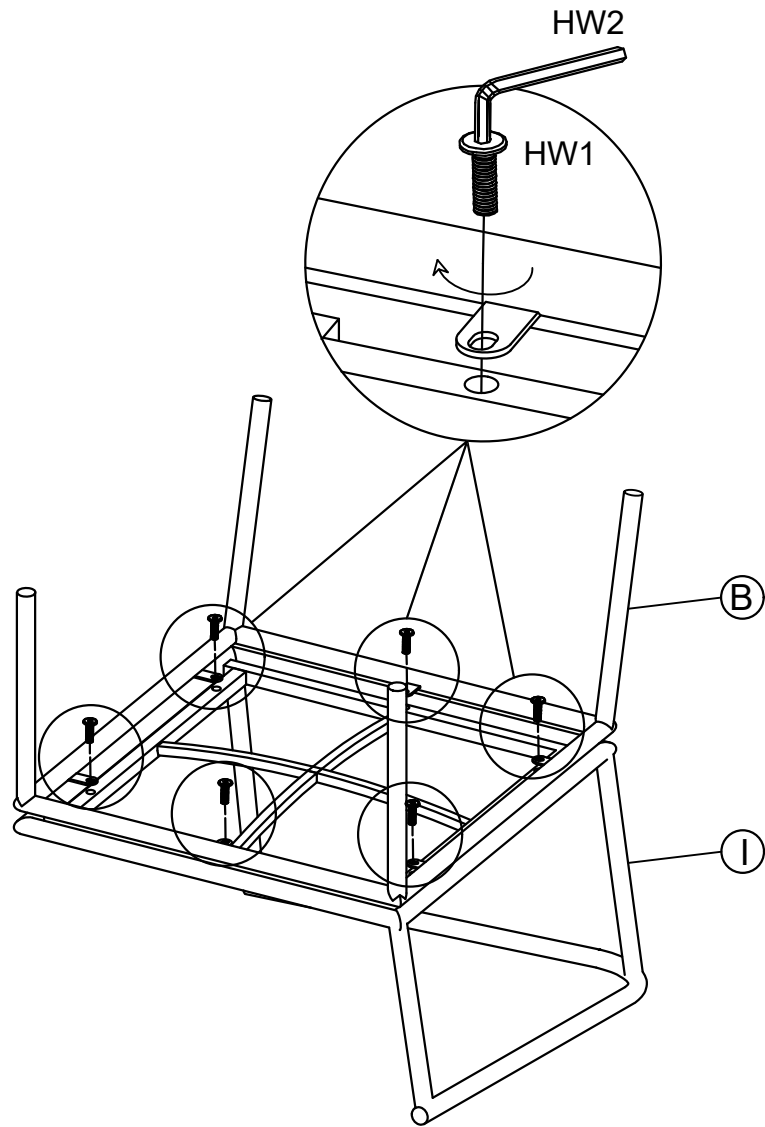

Step 1  
Attach Chair Leg - 1 (B) to Corner Left Seat Frame (I). Use Bolt (HW1) tighten with Allen Key (HW2)

2

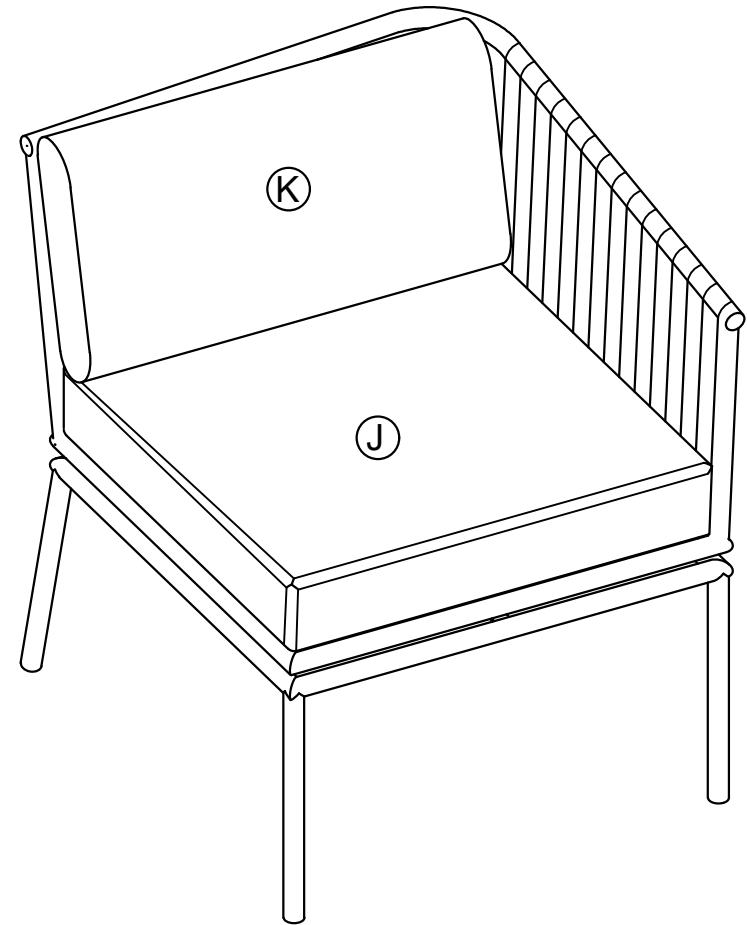

Step 2  
Put on Corner Seat Cushion (J) & Corner Back Long Cushion (K) to complete Corner