

# INSTRUCTION MANUAL

## SECTIONAL SOFA

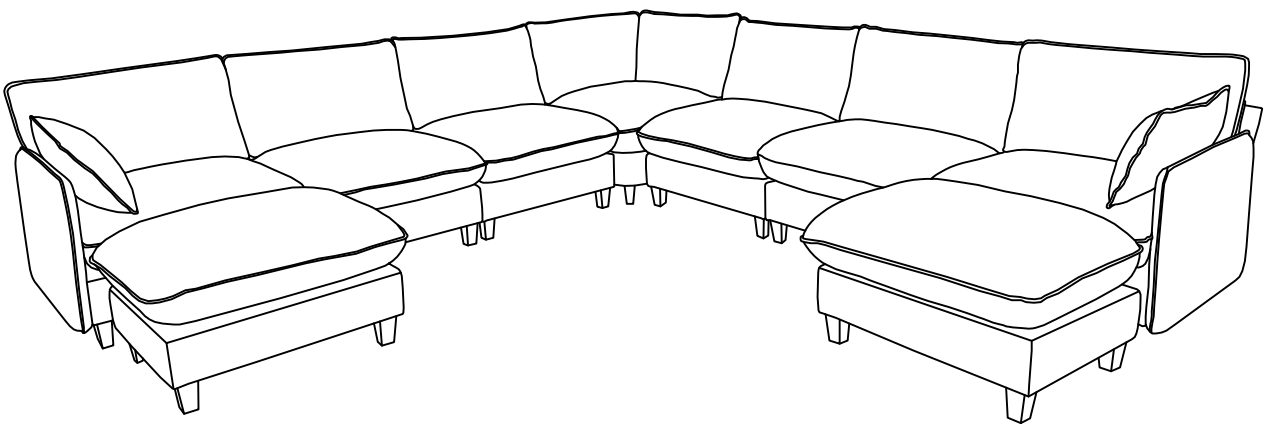

### **Note:**

1. Please confirm all parts are correct before you assemble.
2. This product is shipped in 2-5 boxes (Depending on the seat number you choose), if you only receive one box first, don't worry, other boxes are on the way.
3. Do not tighten fastening fully until assembly is complete.
4. **DO NOT USE POWER TOOLS.** Power tools can over tighten screws.

If you have any questions, please feel free to contact us:

## FAQ

Q1:Missing parts when received.

A1:If you find some parts are missing from the box, please kindly send us messages to let us know the name of missing parts according to the parts list of the instruction, we will send you the replacement asap.

Q2:Difficult to assemble.

A2:It is best for two people to install the sofa. If there are any problems during the installation process, you can take photos and send them to us, and we will reply promptly. There are also installation videos on our Amazon page that you can view online.

Q3:Some parts were damaged when arrived.

A3:Please send us the clear photo of the damaged part as an attachment, we will check it and offer you the best solution soon.

Q4:Only received one or two boxes.

A4:We normally ship all boxes on the same day, but the boxes may not be delivered together because of the carrier. The delivery time interval between the packages will not normally exceed three days. And you can also contact the seller and ask for the delivery time of the other boxes.

Q5:Want to return the product.

A5: Before returning the item, please contact us regarding the return issue. Please make sure that the box packaging is complete, the product is not damaged, stained, and does not affect secondary sales. Products returned without the original packaging may be rejected, and we may request pictures to be provided.

## QUICK START:

1. Find your variant & check boxes. Different variants ship with different boxes. Before assembly, confirm you've received all boxes. If any box or part is missing or damaged, please contact us by email or through the platform and we'll help right away.

Box	Name
A	Side seat and center seat
B	Side seat and Ottoman
C	Center seat and Ottoman
E	Center seat

Variant	Expected Boxes	Total
3 SEATS & 1 OTTOMANS L SHAPE SOFA	A+B	2
4 SEATS & 2 OTTOMANS U SHAPE SOFA	A+B+C	3
5 SEATS V SHAPE SOFA V SHAPE SOFA	A+A+E	3
7 SEATS & 2 OTTOMANS V SHAPE SOFA	A+A+C+C+E	5

2. Color may vary slightly. Due to lighting and display differences, the actual material color may differ slightly from the photos.

3. Vacuum-packed cushions. To reduce shipping volume, cushions are vacuum-packed. After unsealing, gently pat and fluff each cushion and allow 24–72 hours to fully recover as shown in the images.

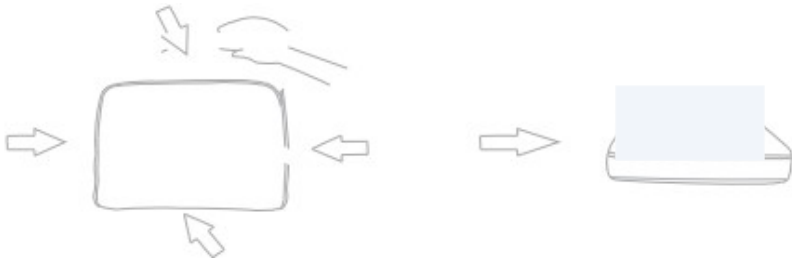

1. Pat to make it rebound better and fluffy.

2. Knead your cushion like giving your cushion a massage while allowing the air to flow through the foam.

## RETURN ISSUE

We offer 30-day returns, please feel free to contact us if you have any questions.

Return requirements:

1. Original carton in good condition.

2. No damage to the product.

Contact Customer Service Team.

# Different Sectional(3 Seats-7 Seats)

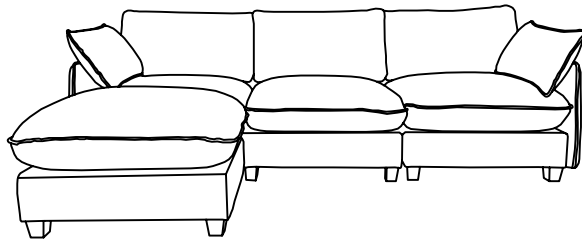
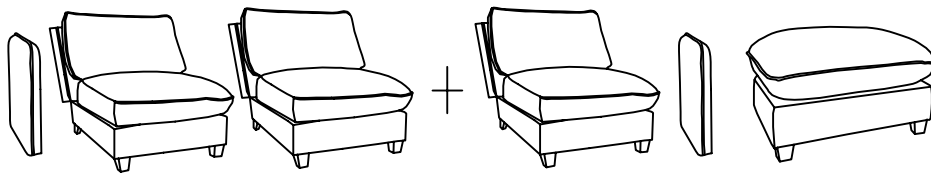

**BOX A+B**

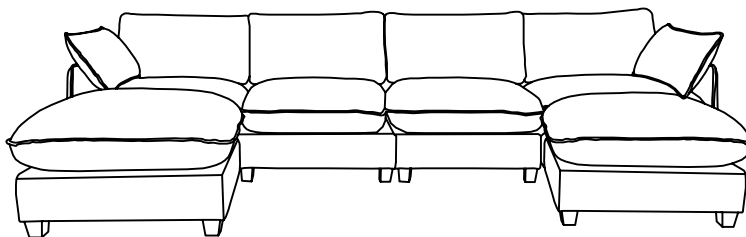
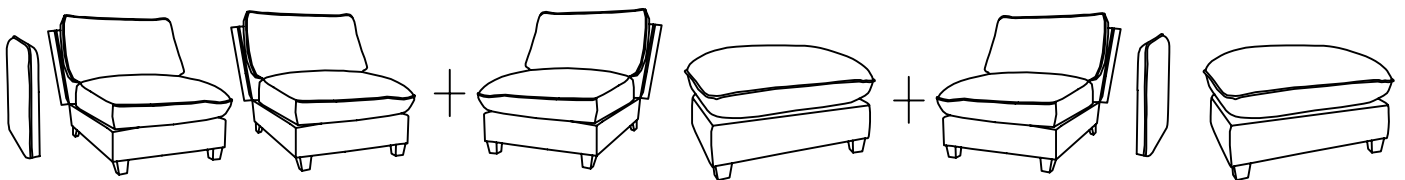

**BOX A+C+B**

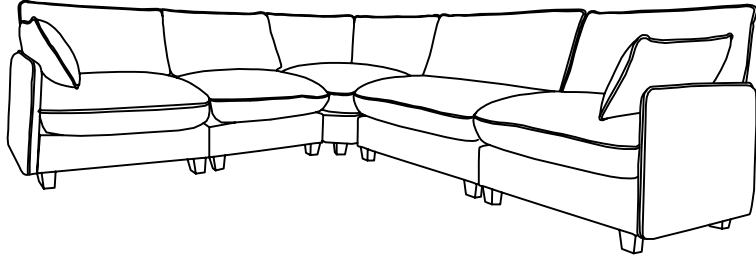
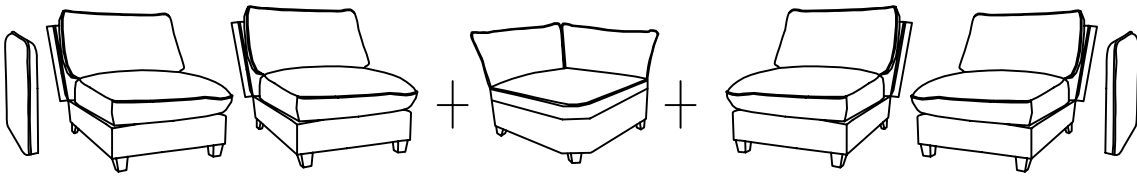

BOX A+E+A

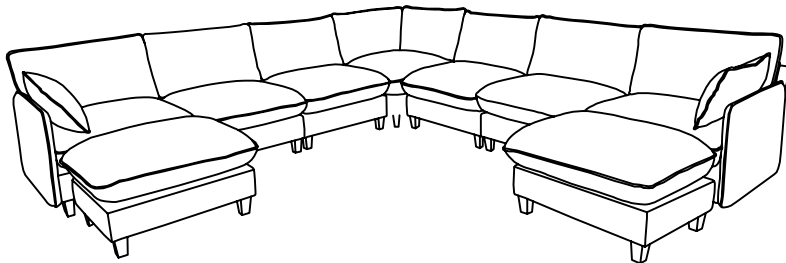
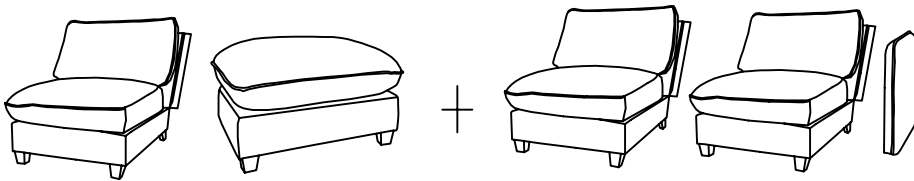

BOX A+C+E+C+A

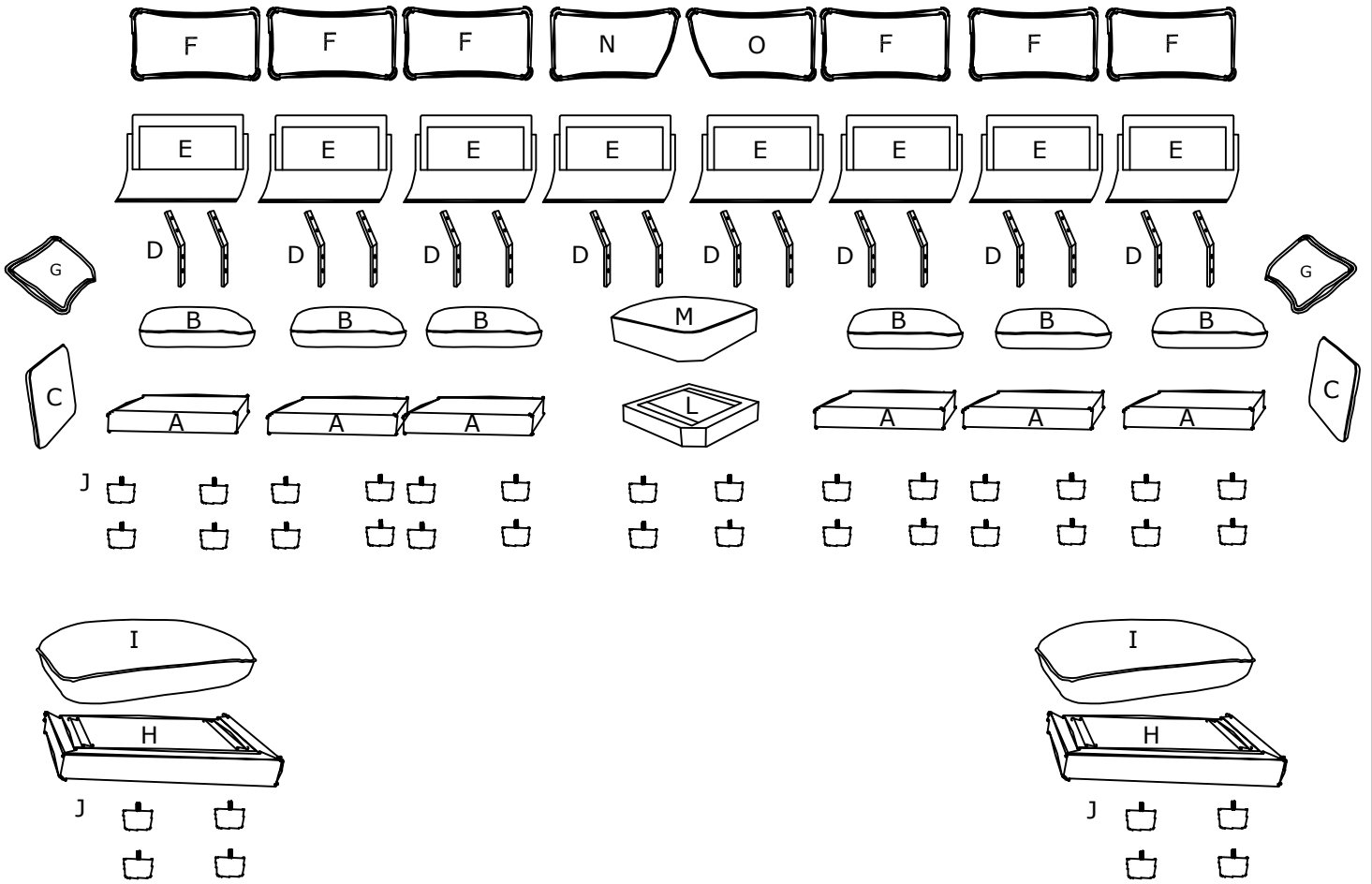

TOOLS REQUIRED:  SCISSORS(NOT INCLUDED)



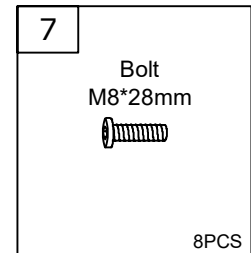
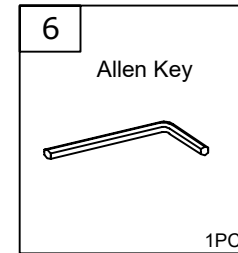
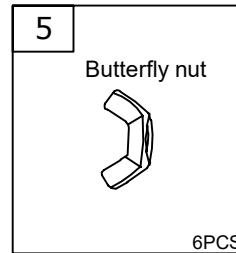
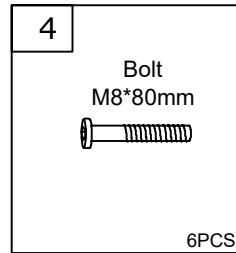
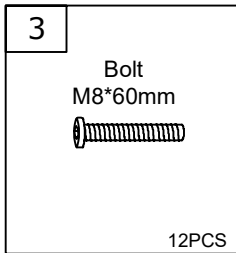
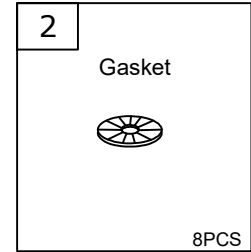
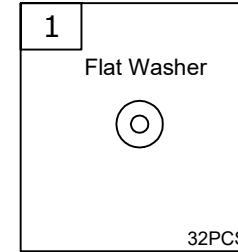
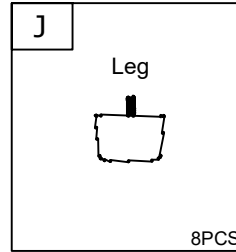
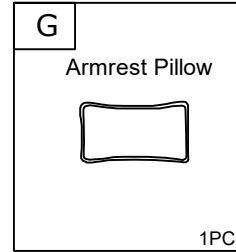
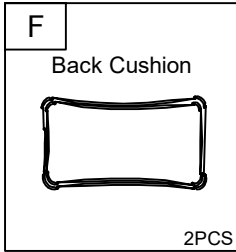
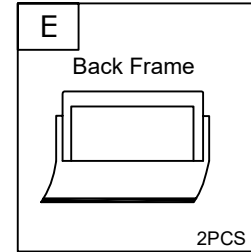
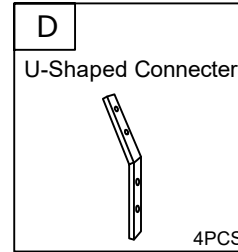
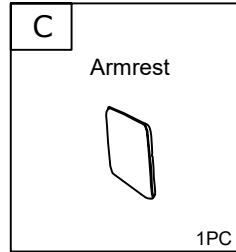
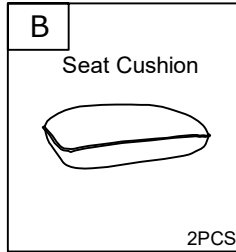
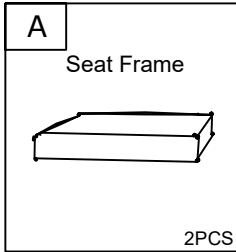



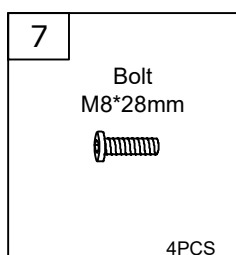
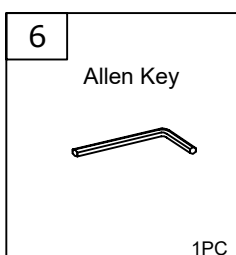
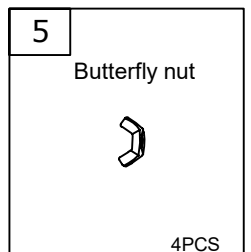
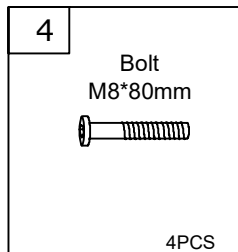
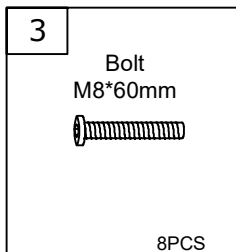
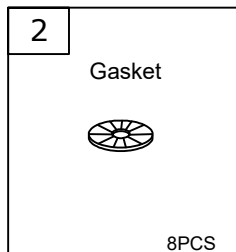
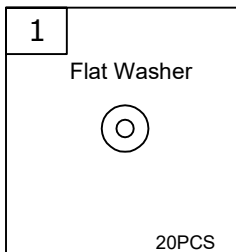
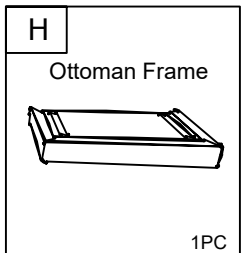
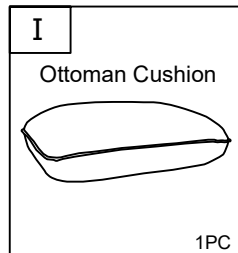
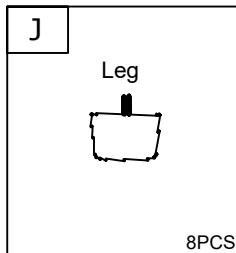
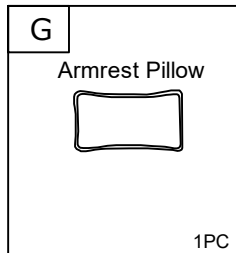
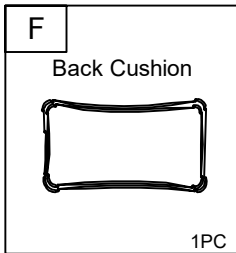
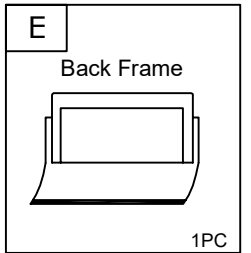
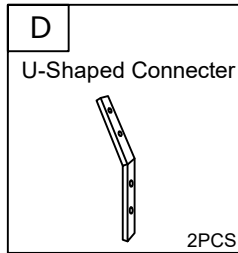
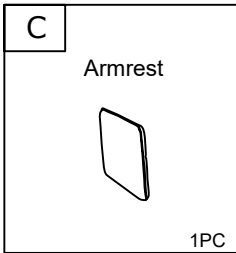
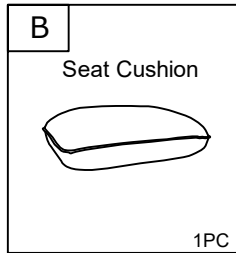
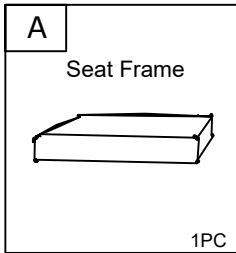



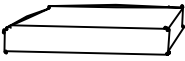

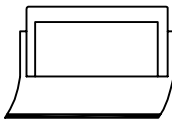

## BOX A

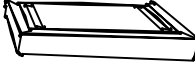



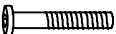







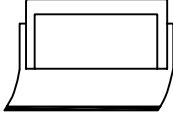
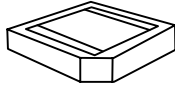

## BOX B



## BOX C





<p><b>A</b></p> <p>Seat Frame</p>  <p>1PC</p>	<p><b>B</b></p> <p>Seat Cushion</p>  <p>1PC</p>	<p><b>D</b></p> <p>U-Shaped Connector</p>  <p>2PCS</p>	<p><b>E</b></p> <p>Back Frame</p>  <p>1PC</p>	<p><b>F</b></p> <p>Back Cushion</p>  <p>1PC</p>
<p><b>J</b></p> <p>Leg</p>  <p>8PCS</p>	<p><b>I</b></p> <p>Ottoman Cushion</p>  <p>1PC</p>	<p><b>H</b></p> <p>Ottoman Frame</p>  <p>1PC</p>	<p><b>1</b></p> <p>Flat Washer</p>  <p>16PCS</p>	<p><b>2</b></p> <p>Gasket</p>  <p>8PCS</p>
<p><b>3</b></p> <p>Bolt M8*60mm</p>  <p>4PCS</p>	<p><b>4</b></p> <p>Bolt M8*80mm</p>  <p>4PCS</p>	<p><b>5</b></p> <p>Butterfly Nut</p>  <p>4CS</p>	<p><b>6</b></p> <p>Allen Key</p>  <p>1PC</p>	<p><b>7</b></p> <p>Bolt M8*28mm</p>  <p>4PCS</p>

## BOX E

<p><b>D</b></p> <p>Back support brace</p>  <p>4PCS</p>	<p><b>J</b></p> <p>Leg</p>  <p>4PCS</p>	<p><b>E</b></p> <p>Back Frame</p>  <p>2PCS</p>	<p><b>L</b></p> <p>Seat Frame</p>  <p>1PC</p>	<p><b>M</b></p> <p>Seat Cushion</p>  <p>1PC</p>
<p><b>N</b></p> <p>Back Cushion</p>  <p>1PC</p>	<p><b>O</b></p> <p>Back Cushion</p>  <p>1PC</p>	<p><b>P</b></p> <p>U-Shaped Connector</p>  <p>4PCS</p>	<p><b>1</b></p> <p>Flat Washer</p>  <p>24PCS</p>	<p><b>2</b></p> <p>Gasket</p>  <p>4PCS</p>
<p><b>3</b></p> <p>Bolt M8*60mm</p>  <p>8PCS</p>	<p><b>6</b></p> <p>Allen Key</p>  <p>1PC</p>	<p><b>7</b></p> <p>Bolt M8*28mm</p>  <p>16PCS</p>		

## DIAGRAM 1 Assemble the Armrest(left)

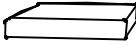

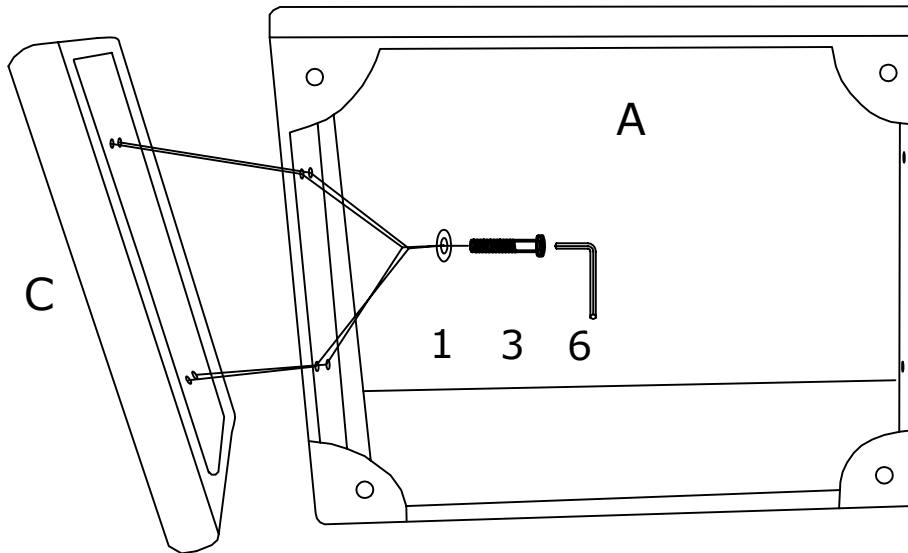

Assemble the left armrest (part C ) to the seat frame (part A) with washers (hardware 1) and screws (hardware 3)

1		4PCS
3		4PCS
A		1PC
C		1PC





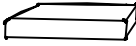

## DIAGRAM 2 Assemble the Armrest(Right)

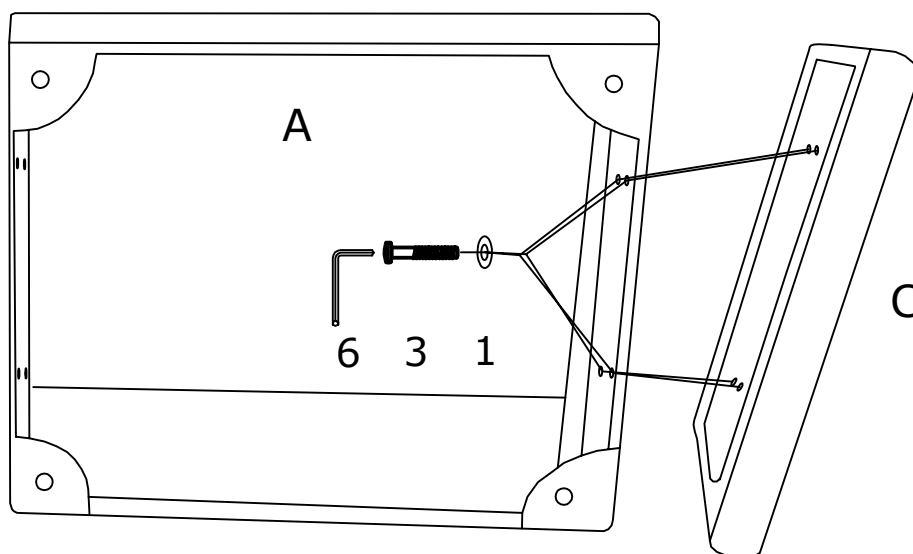
Assemble the left armrest (part C ) to the seat frame (part A) with washers (hardware 1) and screws (hardware 3)

1		4
3		4
A		1
C		1



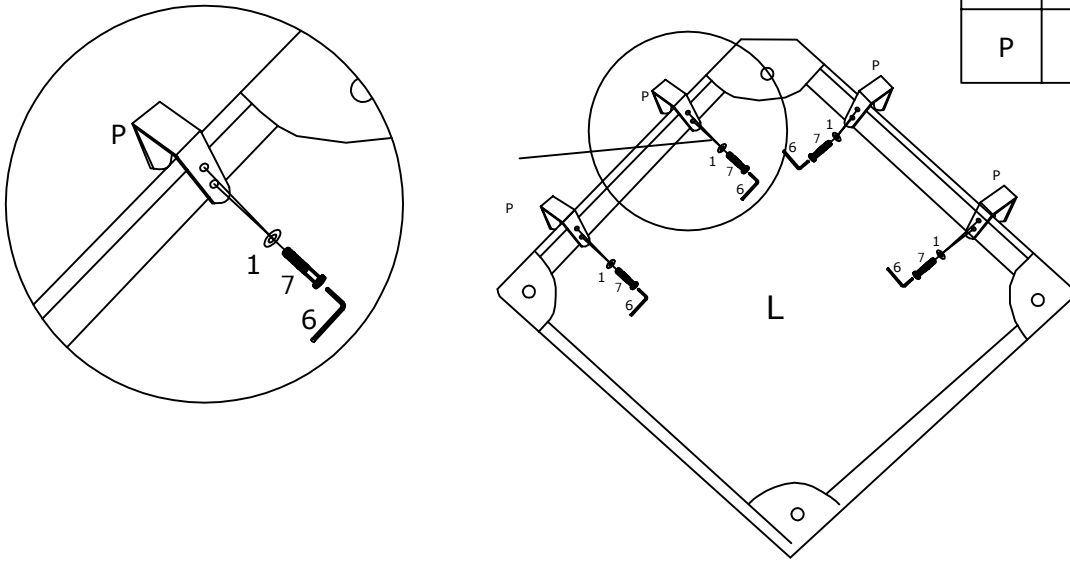

### DIAGRAM 3 Assemble the U-Shaped Connector

1		8PCS
8		8PCS
L		1PC
P		4PCS



### DIAGRAM 4 Assemble the seat frame

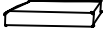

Assemble the seat frame (part A) and seat frame(part A) with butterfly nuts (hardware 5) washers (hardware 1) and screws (hardware 4).

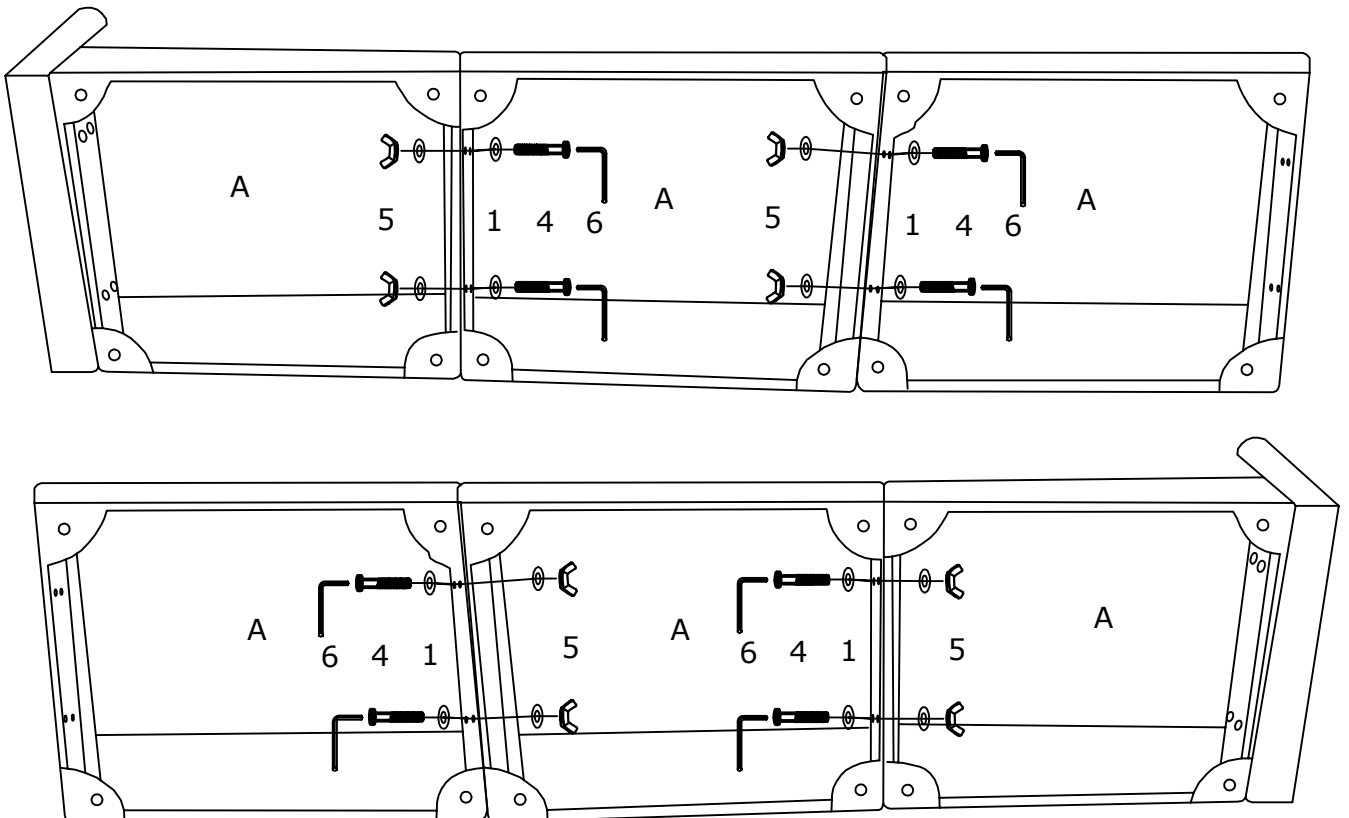
1		32PCS
4		16PCS
4		16PCS
A		6PCS



### DIAGRAM 5 Assemble the sofa feet.

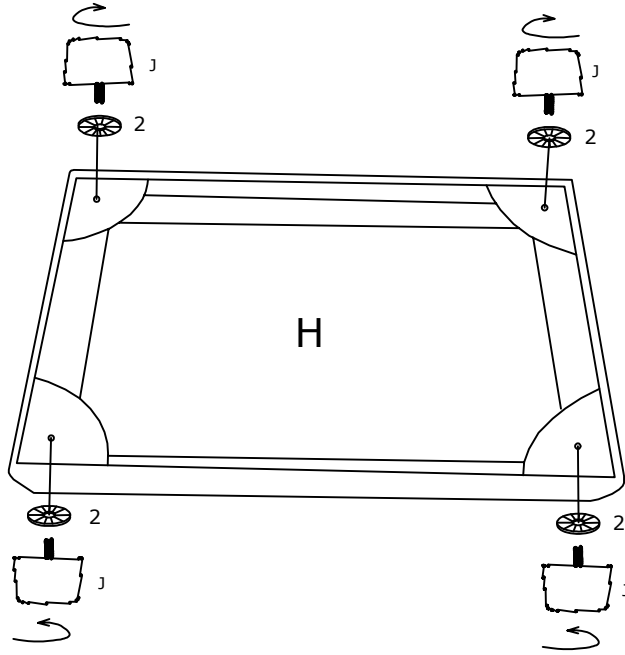

Assemble the Legs (Part J) on the sofa with Gaskets (Hardware 2)

J		4PCS
2		4PCS



### DIAGRAM 6 Assemble the sofa feet

Assemble the Legs (Part J) on the sofa with Gaskets (Hardware 2)

J		28PCS
2		28PCS

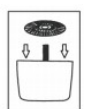
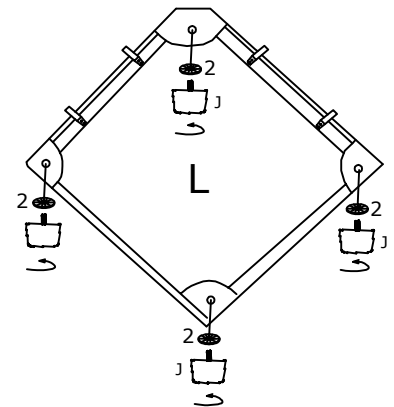
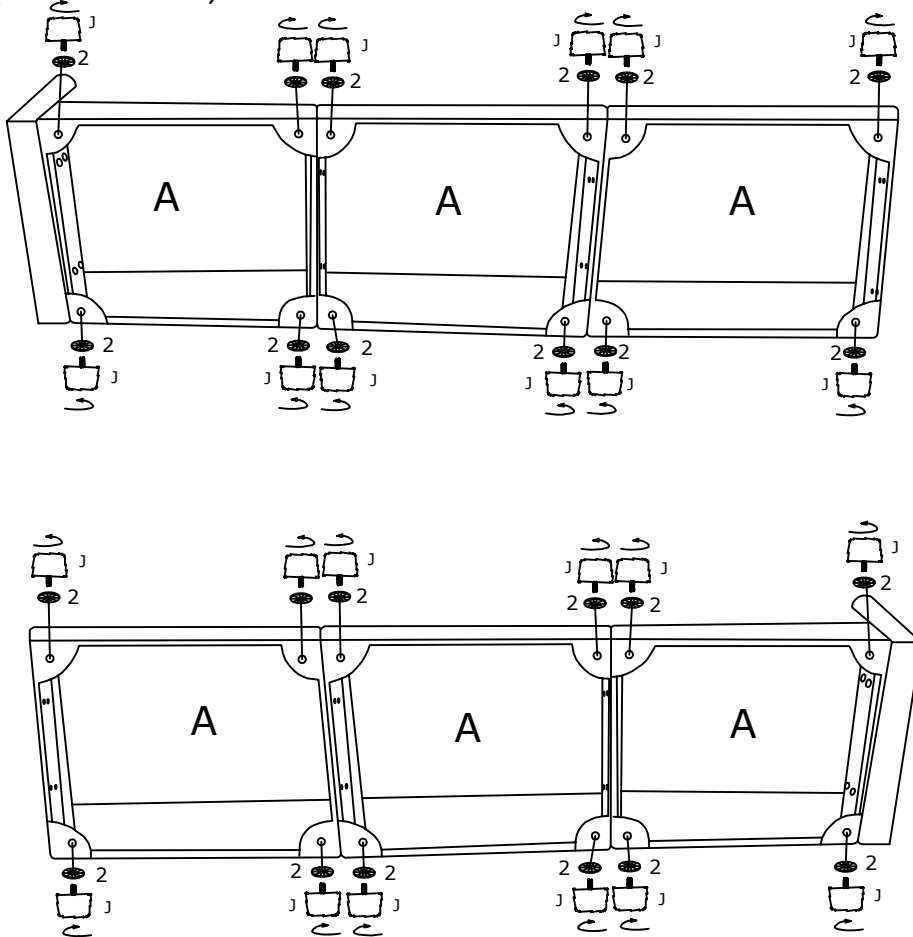

## DIAGRAM 7 Assemble the seat frame onto the U-Shaped Connector

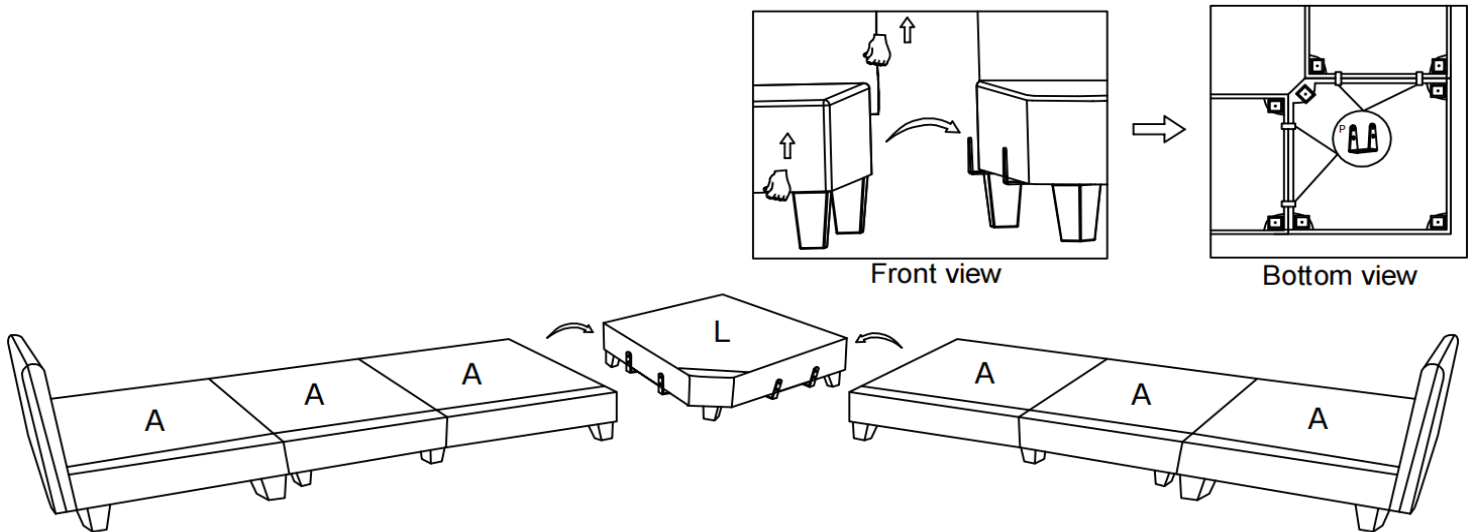

## DIAGRAM 8

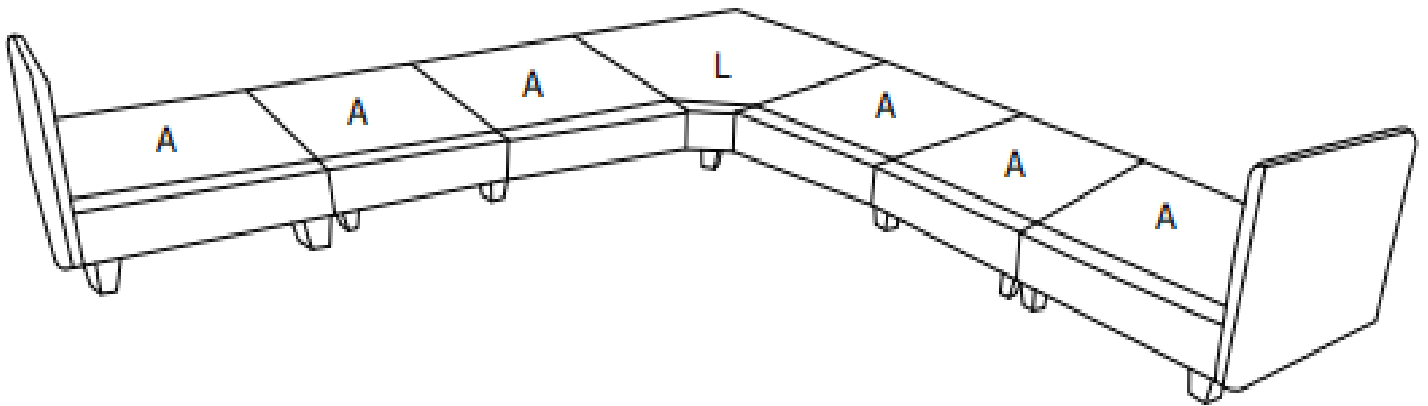

## DIAGRAM 9 Assemble the back frame bracket

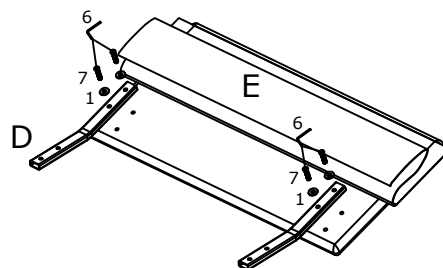

1		4PCS
7		4PCS
D		2PCS
E		1PC

First, tighten the screw to about 80%

DIAGRAM 10 Assemble the back frame bracket with seatframe.

1	⊙	24PCS
3	—	24PCS

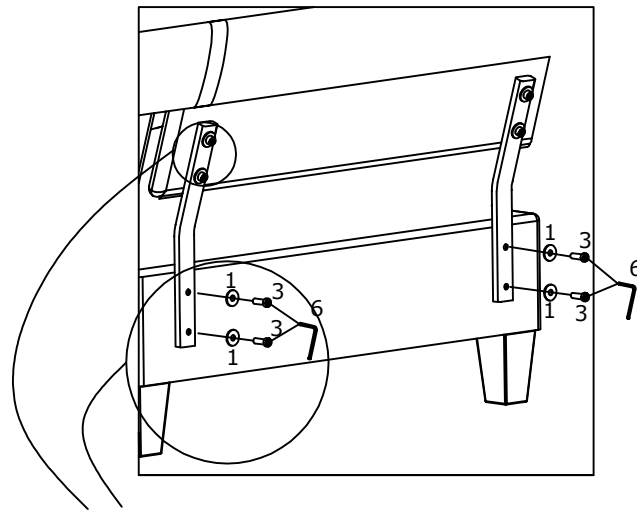
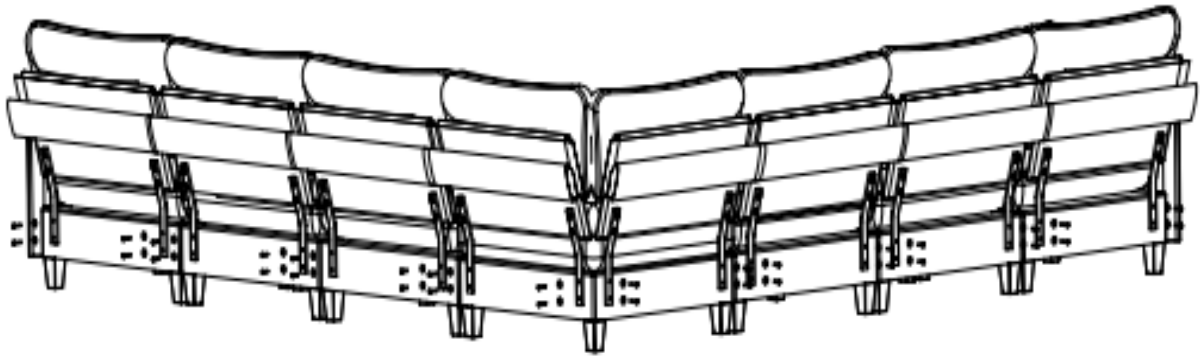

After the screw which connected to the seatframe is tightened to 100%, the screw from the previous step is also tightened to 100%.

DIAGRAM 11

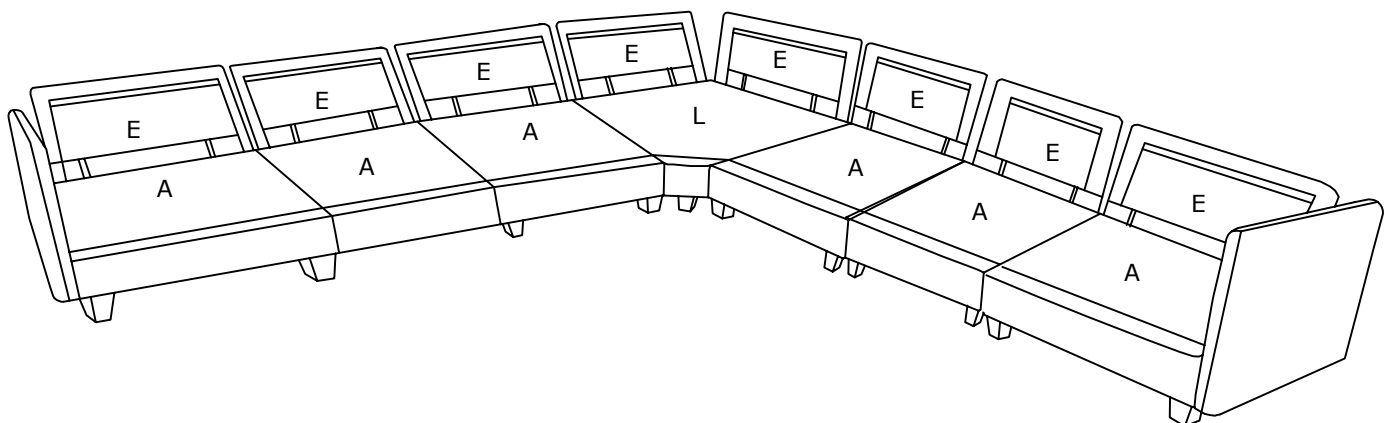

# DIAGRAM 12

The cushions are packaged by vacuum compression. After opening the package, they rebounds quickly within 4 hours, If the fabric has wrinkles, they will basically disappear after about 72 hours.

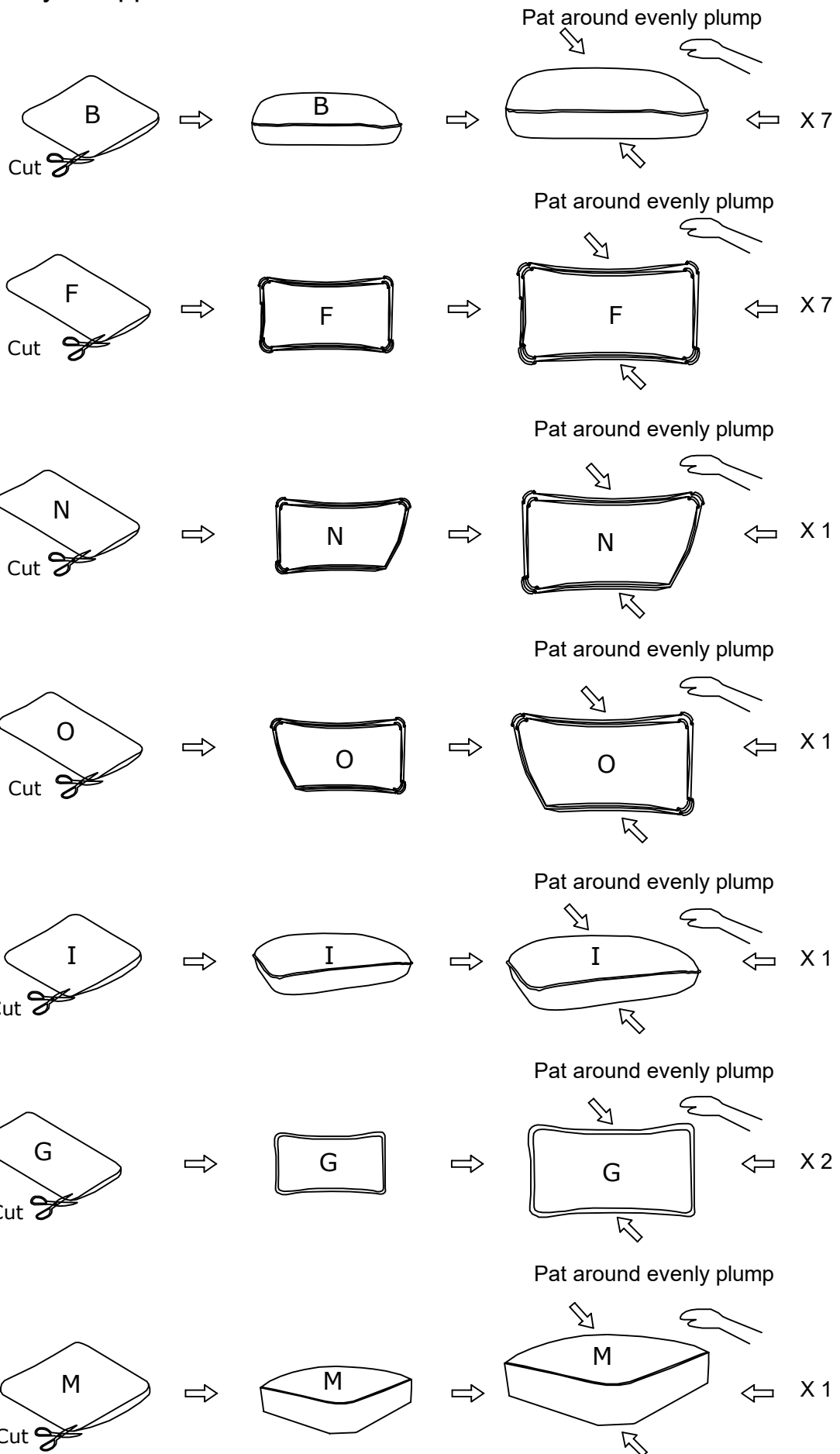

### DIAGRAM 13

**Pleas note:** Peel of the protective black strip from the Velcro.

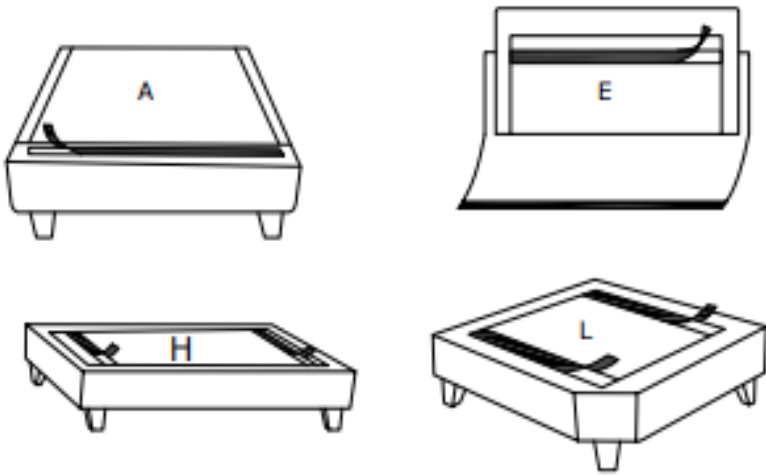

### DIAGRAM 14

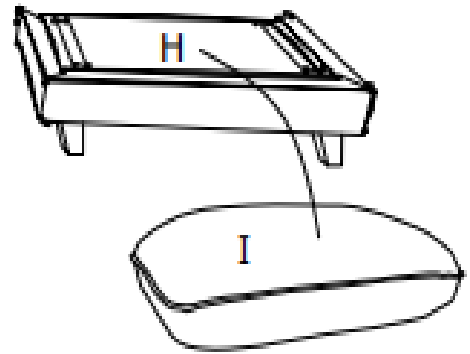

### DIAGRAM 15 Assemble the ottoman cushion.

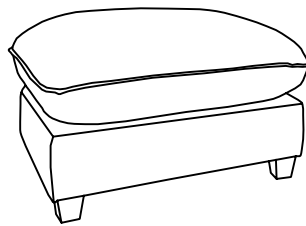

### DIAGRAM 16

