

15'

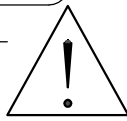

1

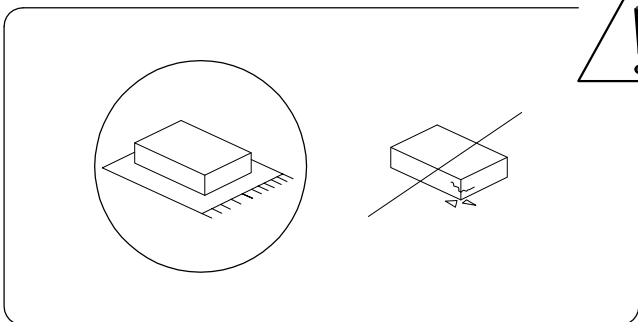

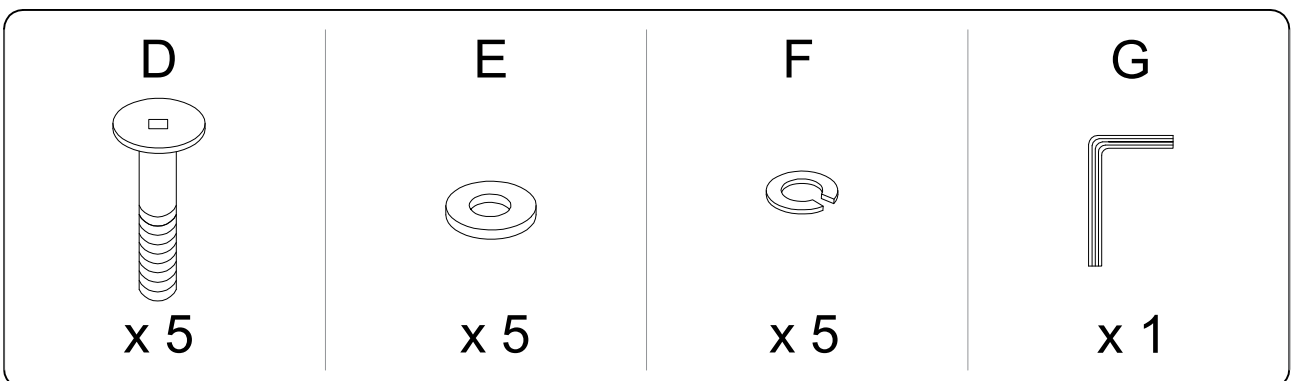
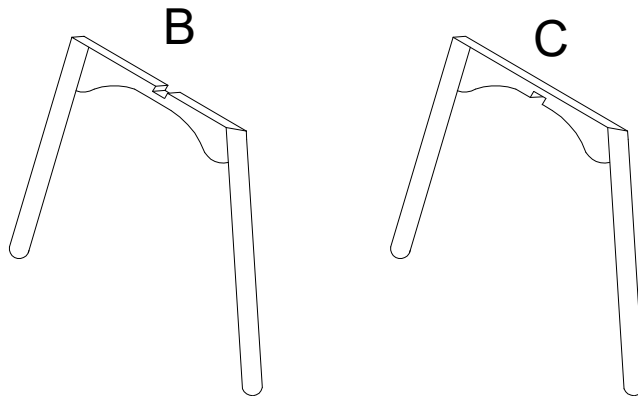
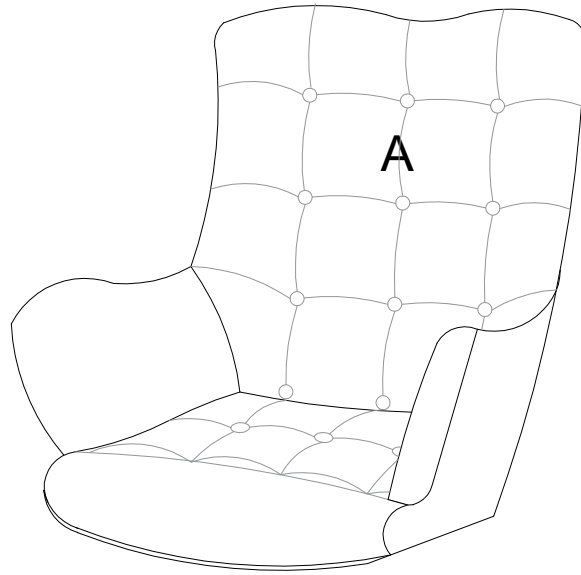
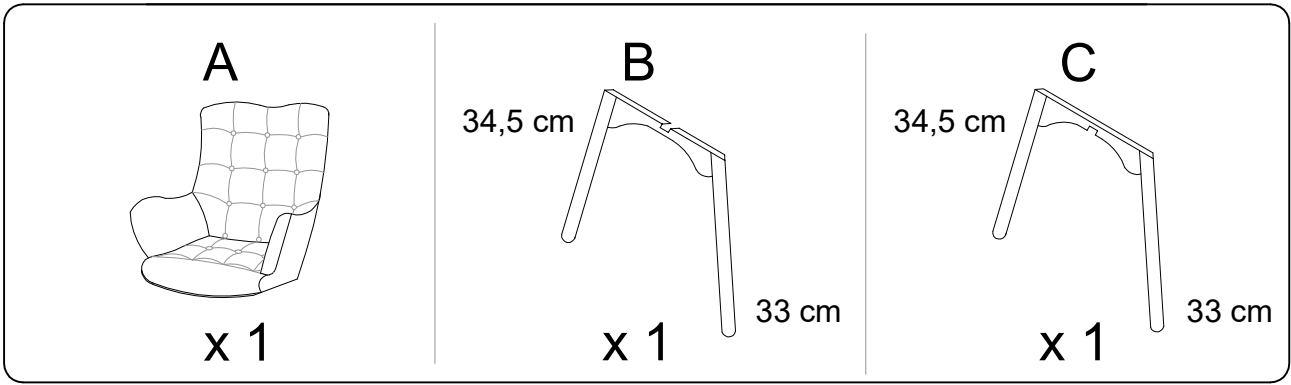

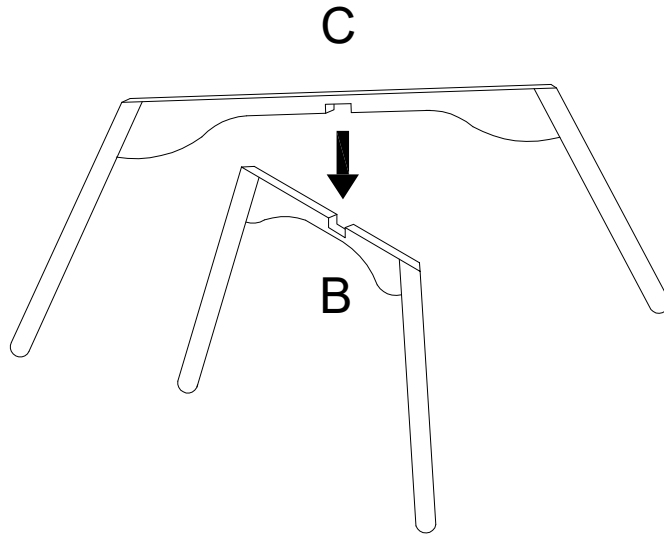
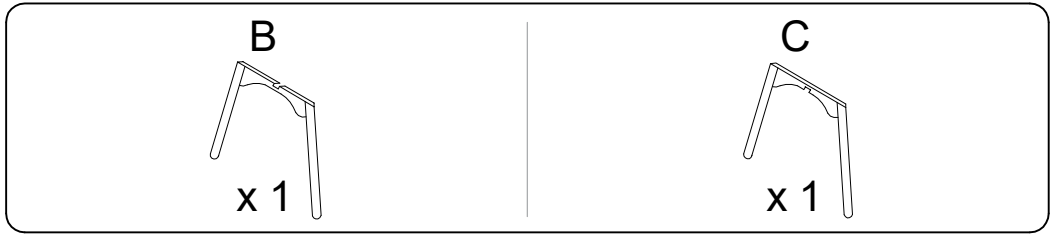

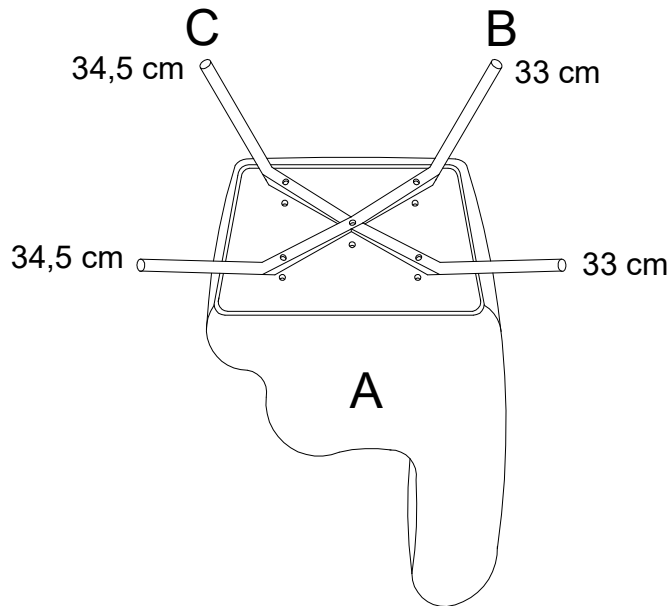
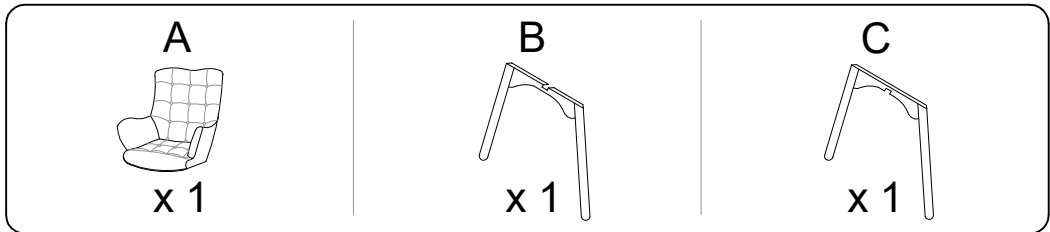

1



2

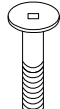

3

A  x 1	B  x 1	C  x 1	D  x 5	E  x 5	F  x 5	G  x 1
--	--	--	--	--	--	--

