

Step 1

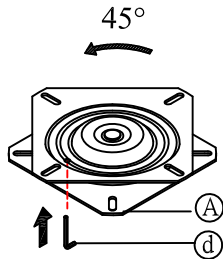

Step 3

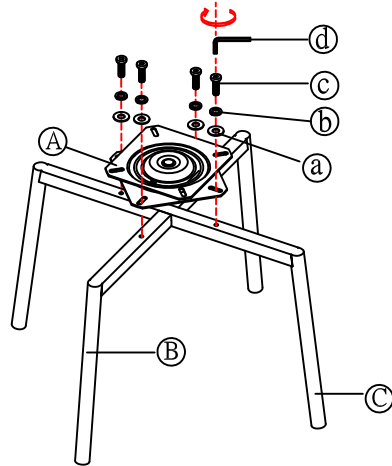

Step 4

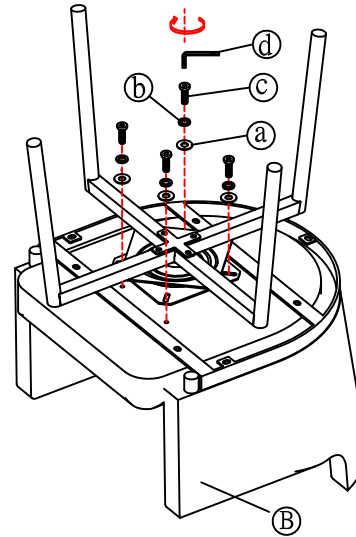

FINISH

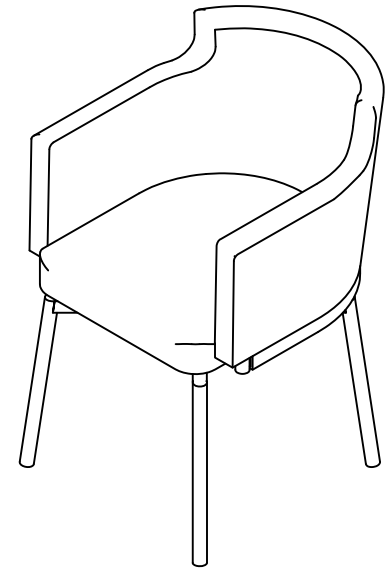



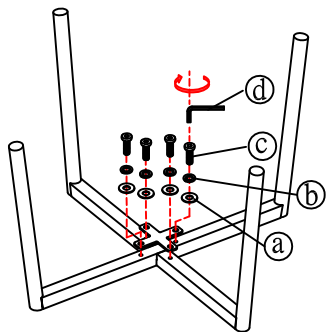

Step 2







BRACKET PACKED WITH SWIVEL PLATE
SEPARATELY FROM THE HARDWARE

PARTS LIST:

NO	DESCRIPTION	SKETCH	QTY
A	SWIVEL		1PC
B	LEG		1PC
C	LEG		1PC
D	SEAT		1PC
E	CORNER BRACKET		1PC

HARDWARE LIST:

NO	DESCRIPTION	SKETCH	QTY
a	WASHER		12PCS
b	SPRING WASHER		12PCS
c	BOLT		12PCS
d	ALLEN KEY		2PCS