

# Owner Manual

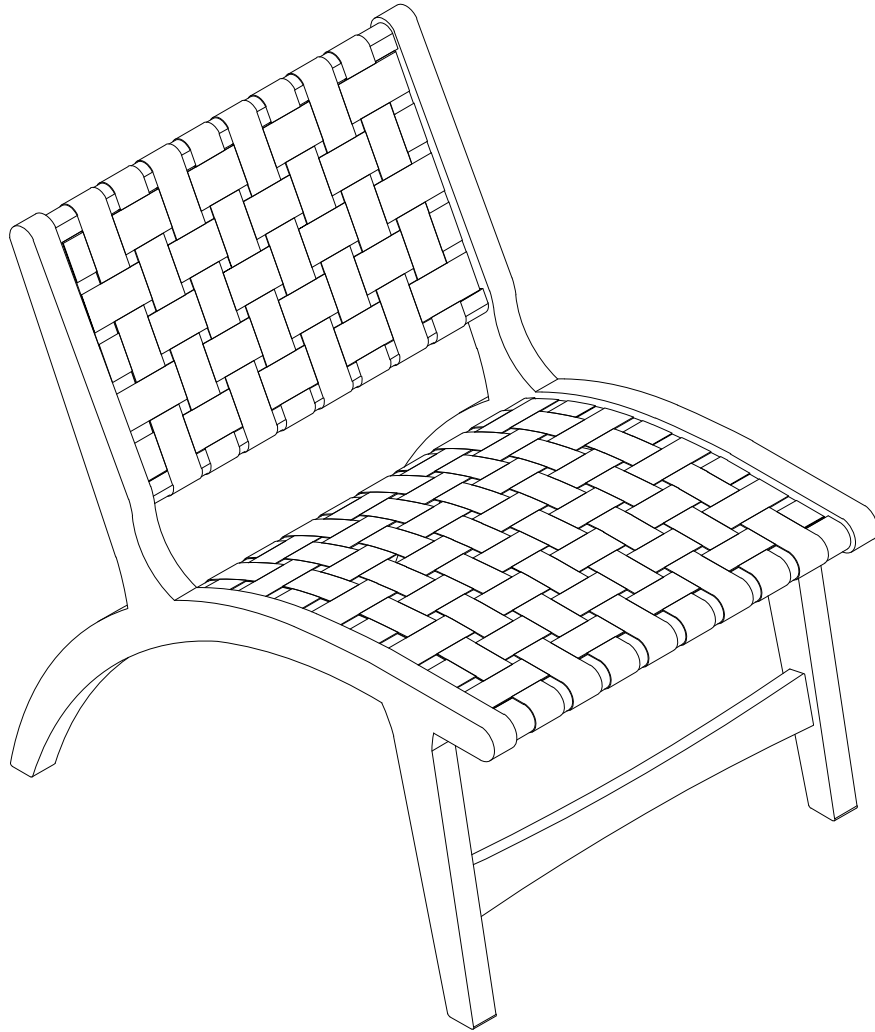

---

## NOTE:

This brochure contains **IMPORTANT** safety info. Please read and keep for future reference.

---

# MAINTAINANCE AND WARNING

- 1.Keep furniture away from heat sources.
- 2.Do not clean furniture with harsh cleaner or polishes.Do not use detergents,solvents,abrasives,spray packs or leather cleaner. Use non-color mild soa with warm water to clean spills(Mix 1:10 soap to water).
- 3.Do not place furniture under direct sunlight,material will possibly fade over time.
- 4.Do not use on site dry cleaning machine.Children should not climb or jump on the furniture.
- 5.Do not write on furniture that is not protectedby a padded barrier.
- 6.Not for commercial use,only for residential use.

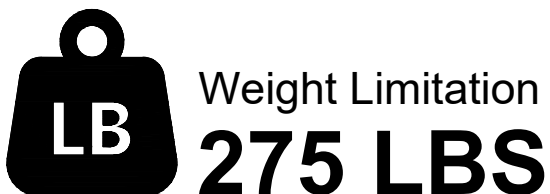

# PARTS LIST

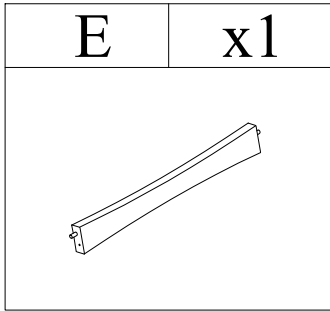
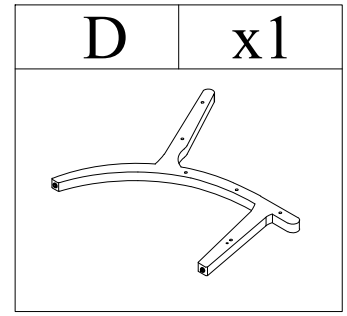
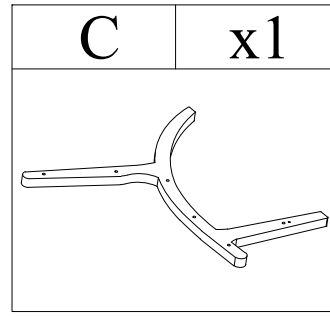
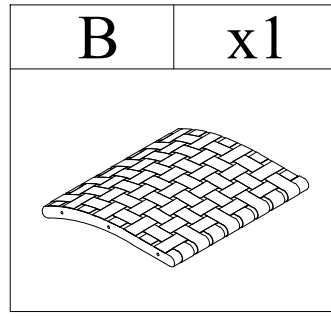
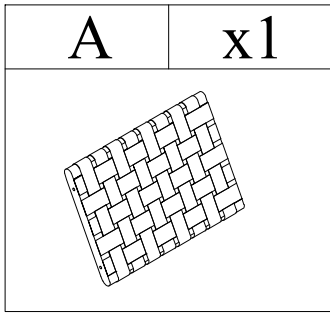

# HARDWARE LIST

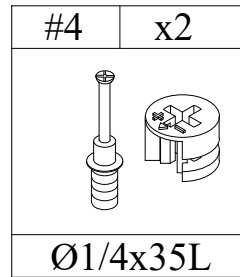
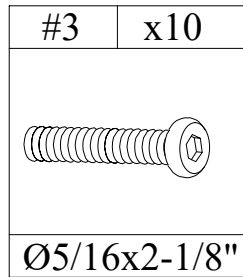
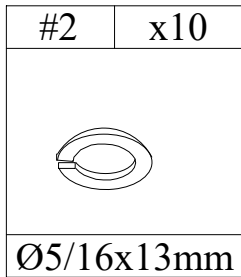
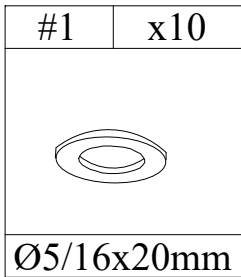

# TOOL LIST

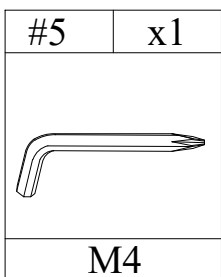

# HARDWARE SPARE LIST

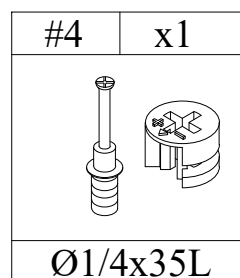
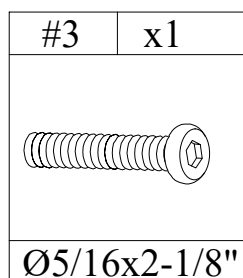
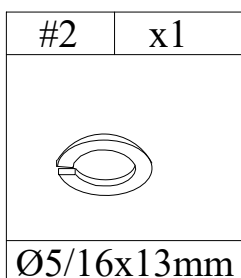
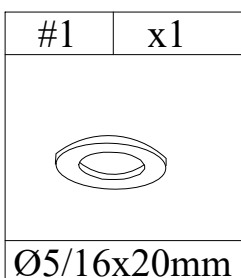

# ASSEMBLY INSTRUCTIONS

## STEP- 1

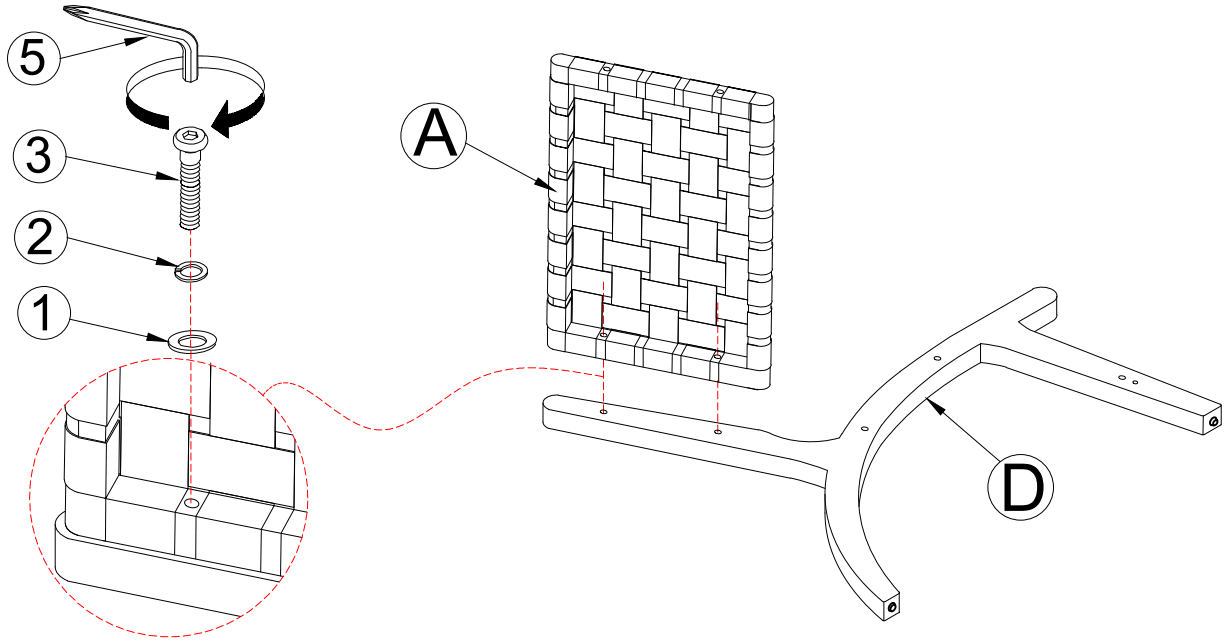

Turn the right leg frame (D) upside down onto a clean, soft surface. Attach the chair back (A) to the right leg frame (D) by using Flat washer (1), Lock Washer (2), Bolt (3) with Allen Key (5) .(Don't tighten bolt).

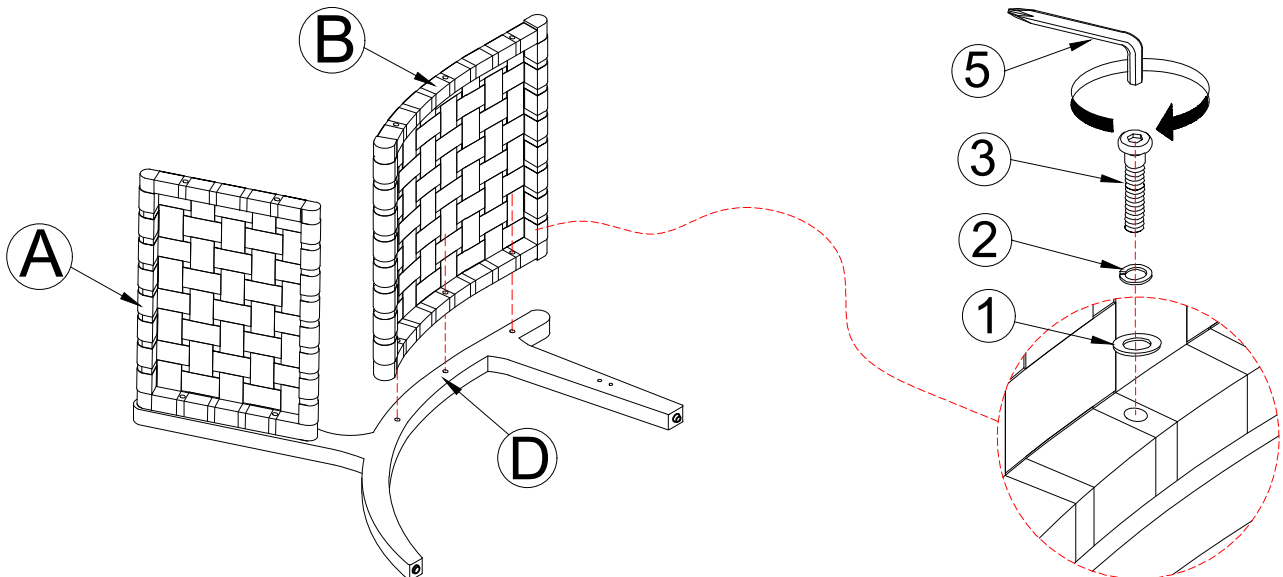

## STEP- 2

Attach the seat frame (B) to the right leg frame (D) by using Flat washer (1), Lock Washer (2), Bolt (3) with Allen Key (5) .(Don't tighten bolt).



1		x5
2		x5
3		x5

5		x1
---	---	----

# ASSEMBLY INSTRUCTIONS

## STEP- 3

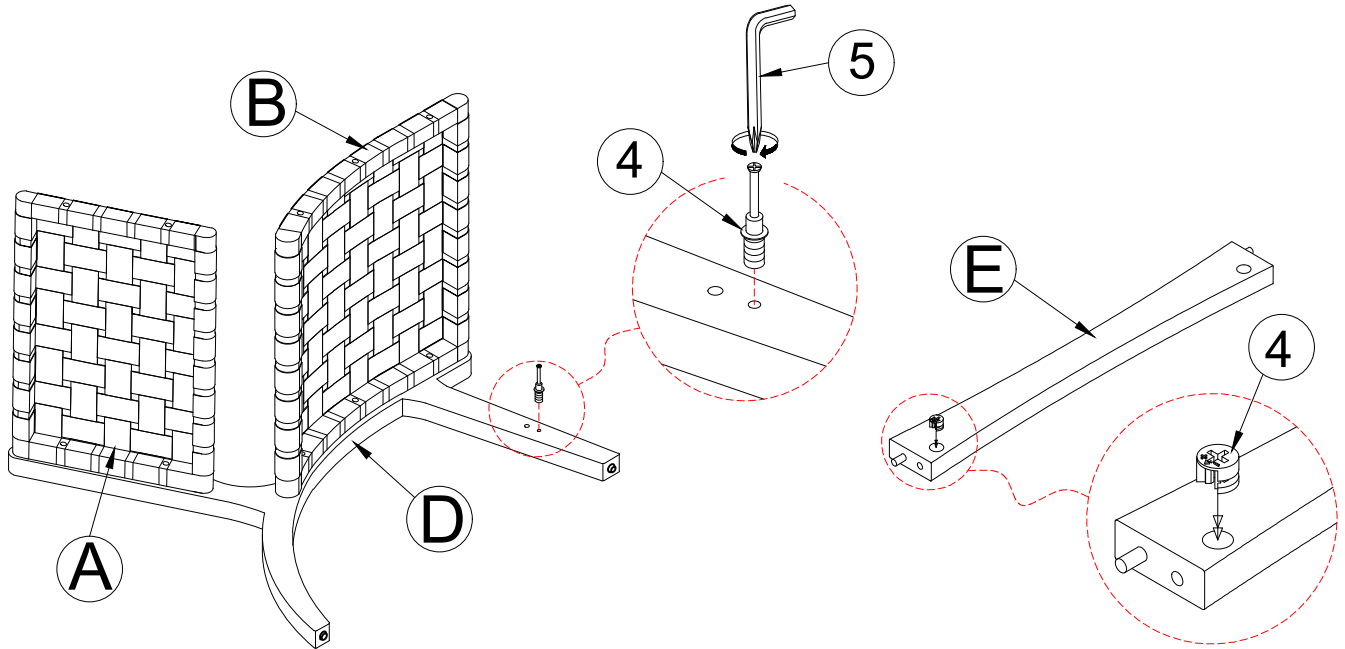

Attach Cam bolt (4) on the right/left leg frame (D),(C) by using Allen Key (5) and Cam lock nut (4) on the stretcher (E).

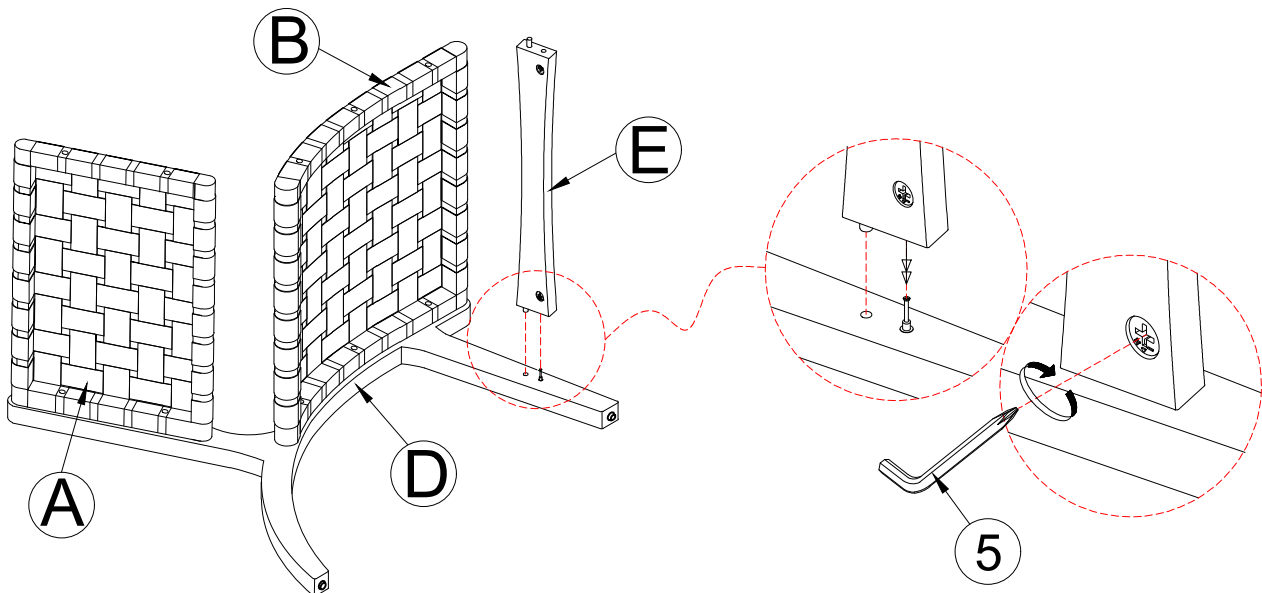

## STEP- 4

Attach Stretcher (E) on the right leg frame (D) by using Allen Key (5).

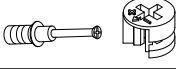



4		x2
5		x1

# ASSEMBLY INSTRUCTIONS

## STEP- 5

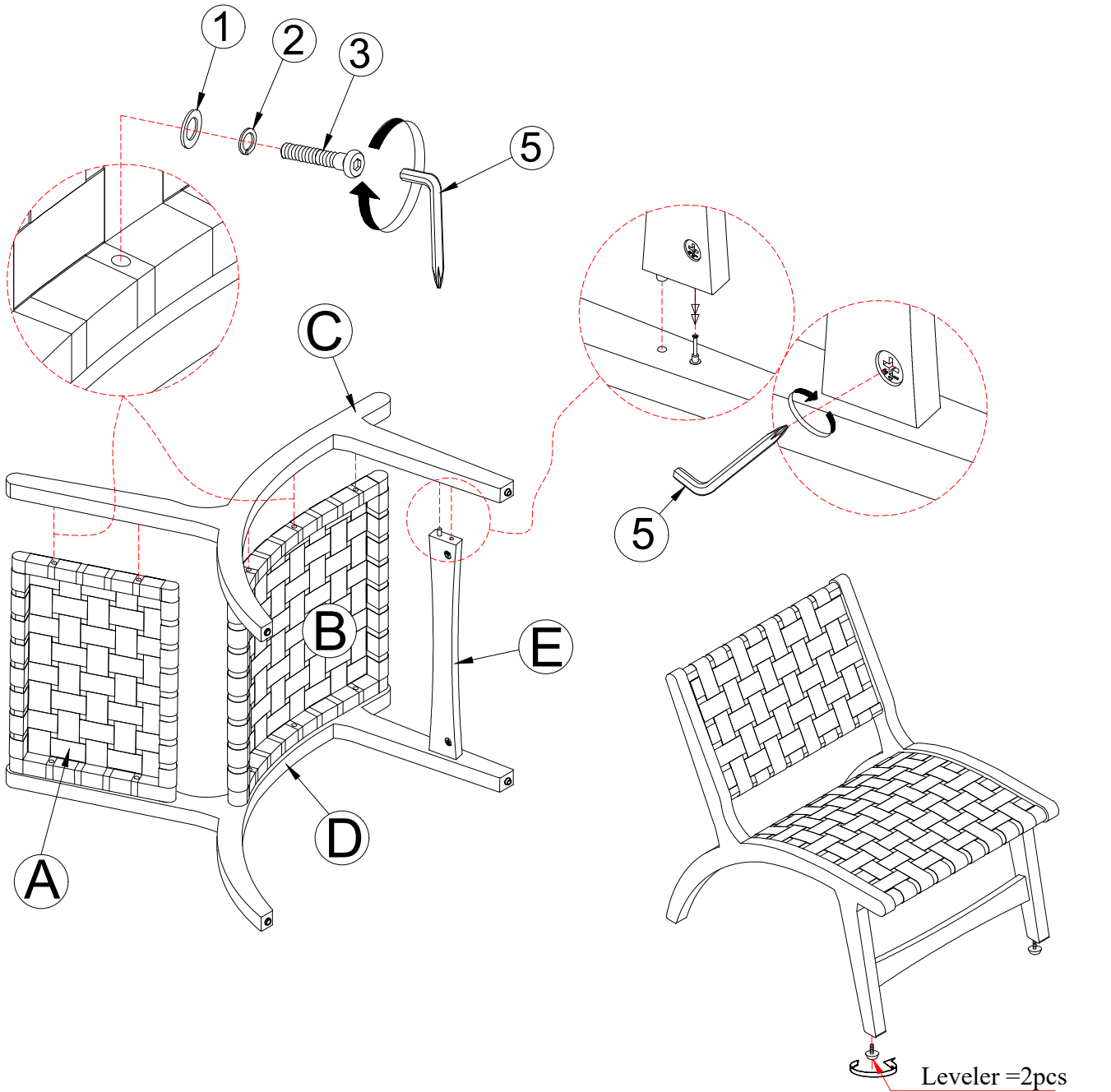
Attach left leg frame (C) on the chair of step 4 by using Flat washer (1), Lock Washer (2), Bolt (3) with Allen Key (5), and using Allen Key (5) connect left leg frame(C) to the stretcher (E).

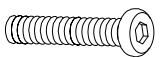

1		x5
2		x5
3		x5

5		x1
---	---	----

 After installation, please keep the chair balanced, tighten all bolts.

# WARRANTY

1. We strive to offer high-quality products, and we also try our best to satisfy each and every customer that orders from us with product or service as needed.
2. We provide 30 days warranty starting from the time you receive the item. Each customer must provide a record of their order such as the order number, or item receipt for any items that are out of the warranty period you may also still receive.
3. Replacement parts by purchasing them with our company if they are available.