



---

INSTRUCTION OF SKI RACK  
(P1027301)

# PARTS

**Bracket 1** x 1

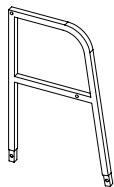

**Bracket 2** x 1



**Bracket 3** x 5



**Bracket 4** x 2

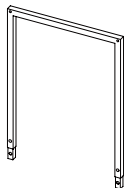

**Bracket 5** x 2

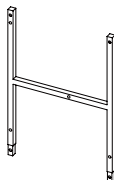

**U-Board 6** x 1

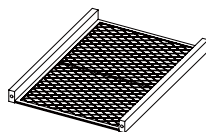

**U-Board 7** x 1

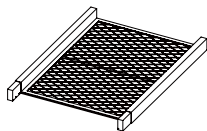

**Iron Net Shelf 8** x 3

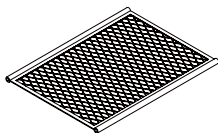

**Round Tube 9** x 2



**Round Tube 10** x 2

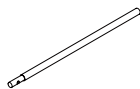

**Wood Shelf 11** x 1

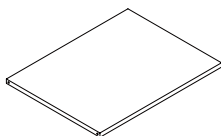

# HARDWARE

**A** x18



M6\*12mm Screw

**B** x22



M6\*30mm Screw

**C** x5

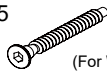

M5\*40mm Screw  
(For Wood)

**D** x 7



Foot Pad

**E** x2

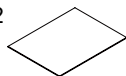

Protective Pad

**F** x6



Protective Pad

x1



(For Wood)  
Small

x1

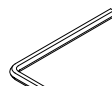

Big

# PARTS OVERVIEW

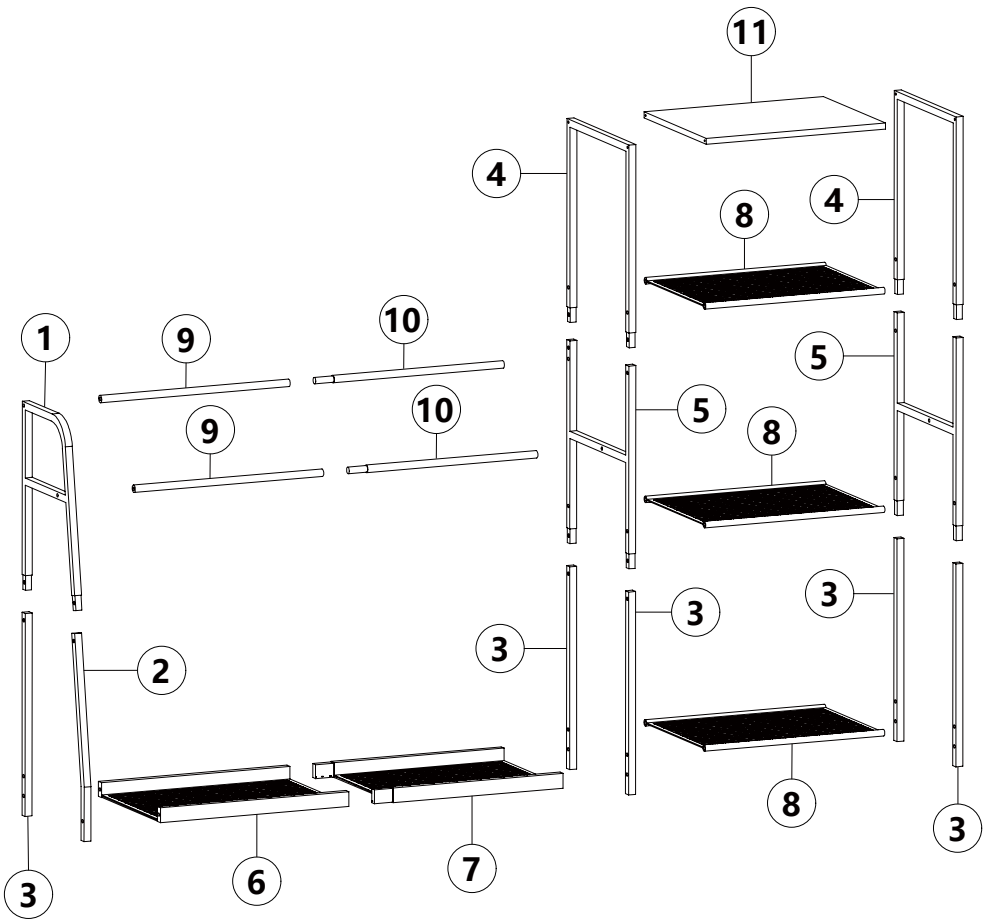

**STEP 1**

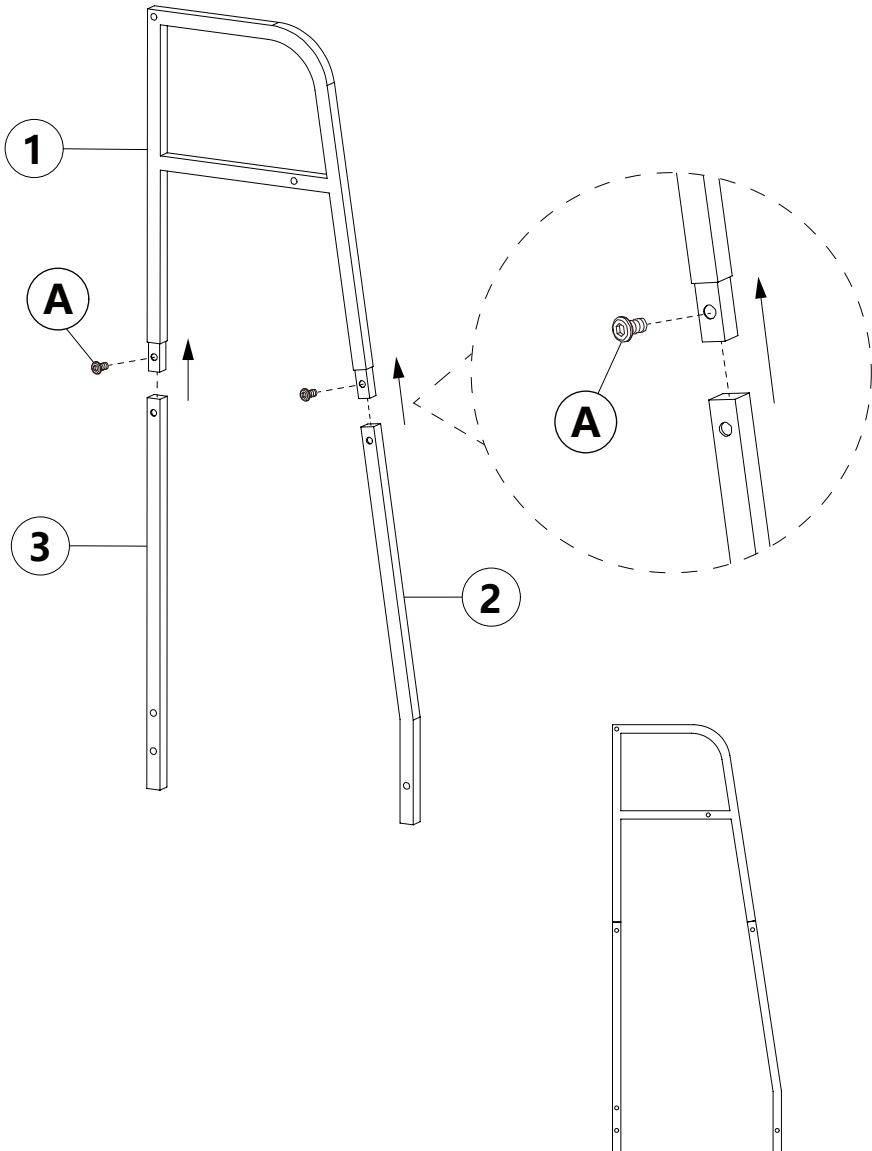
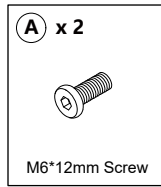
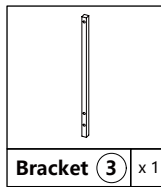
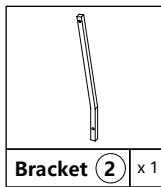
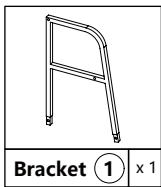

**Assemble one of the brackets**

**STEP 2**

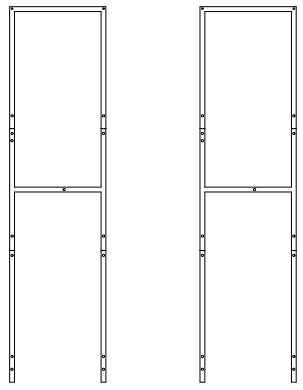
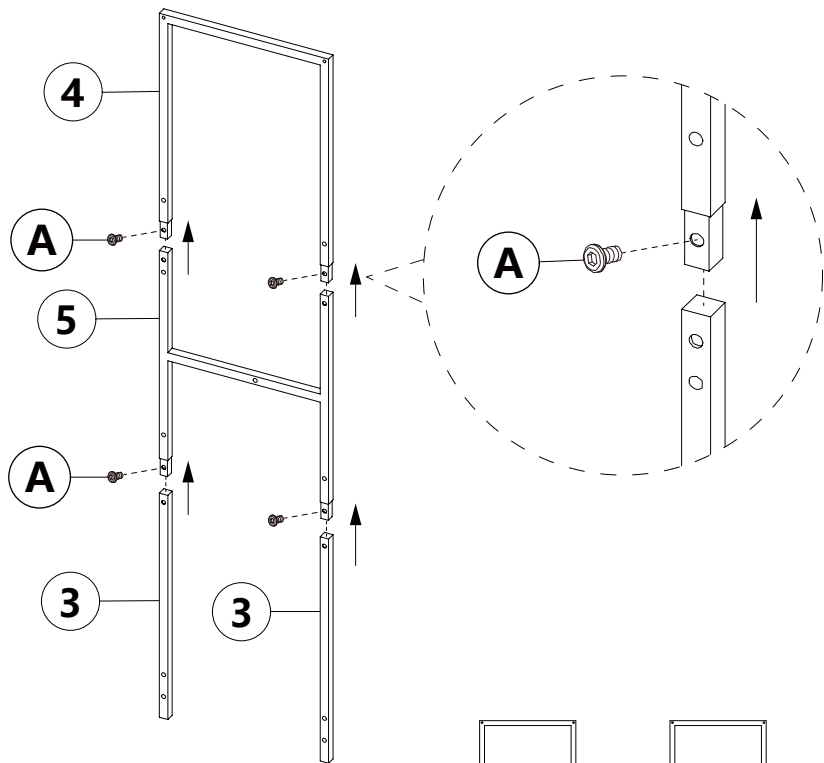
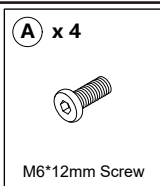
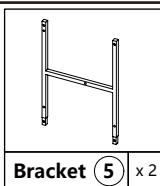
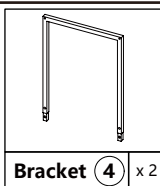
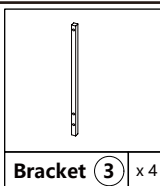

**Assemble two of the brackets**

**STEP 3**

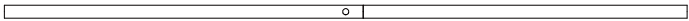
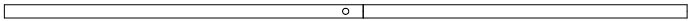
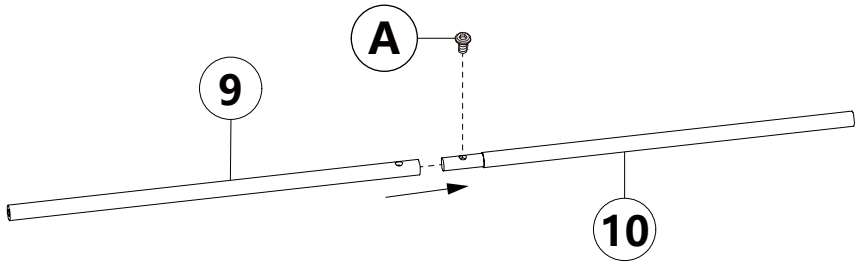
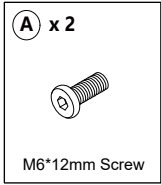
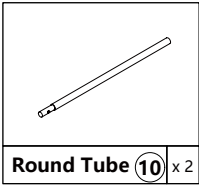
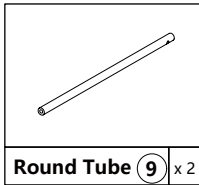

**Assemble two Round Tube**

**STEP 4**

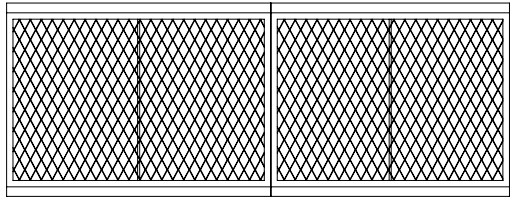
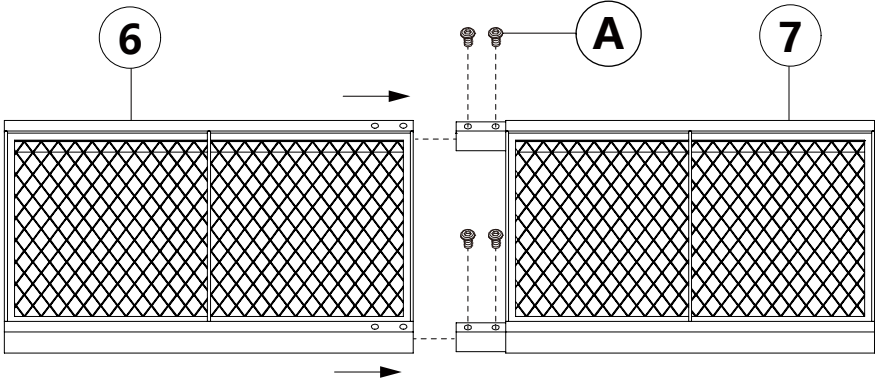
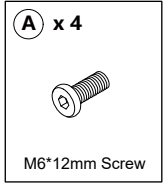
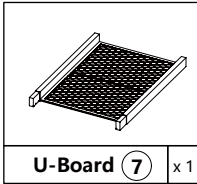
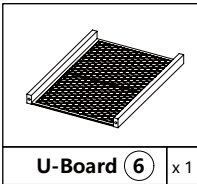

**Assemble U-Board**

**STEP 5**

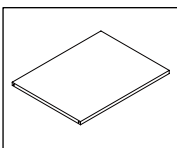

Wood Shelf **(11)** x 1

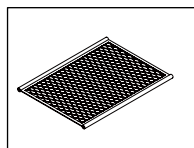

Iron Net Shelf **(8)** x 3

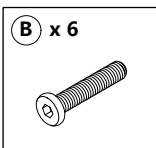

**(B)** x 6  
M6\*30mm Screw

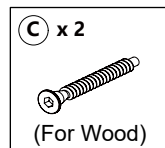

**(C)** x 2  
(For Wood)  
M5\*40mm Screw

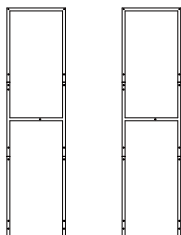

Use the "STEP 2" parts

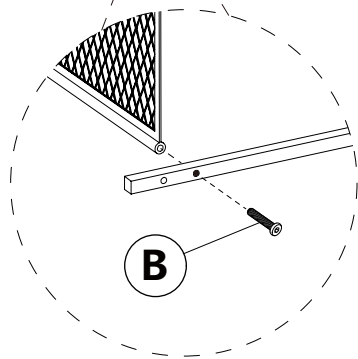
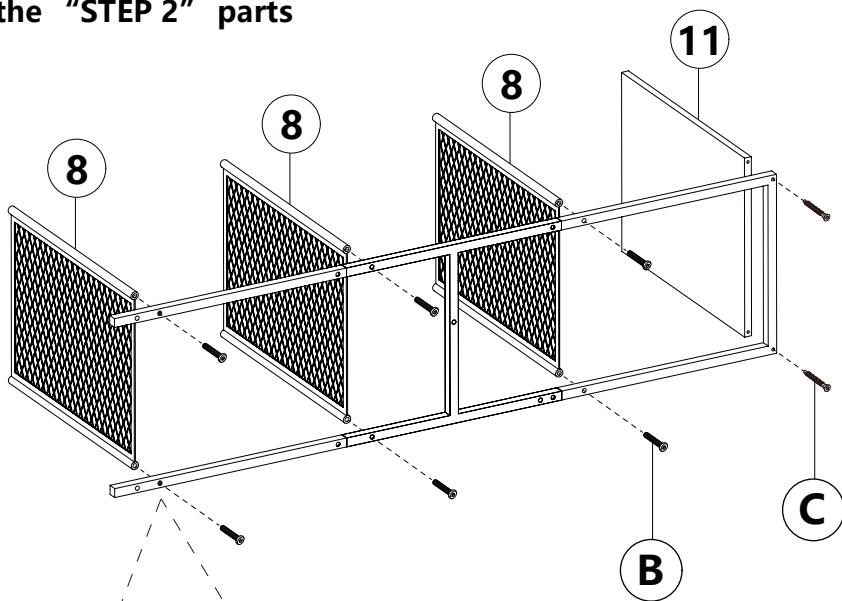

★ Must be this hole

**STEP 6**

**B** x 6



M6\*30mm Screw

**C** x 2



(For Wood)

M5\*40mm Screw

**Align the holes  
on both sides**

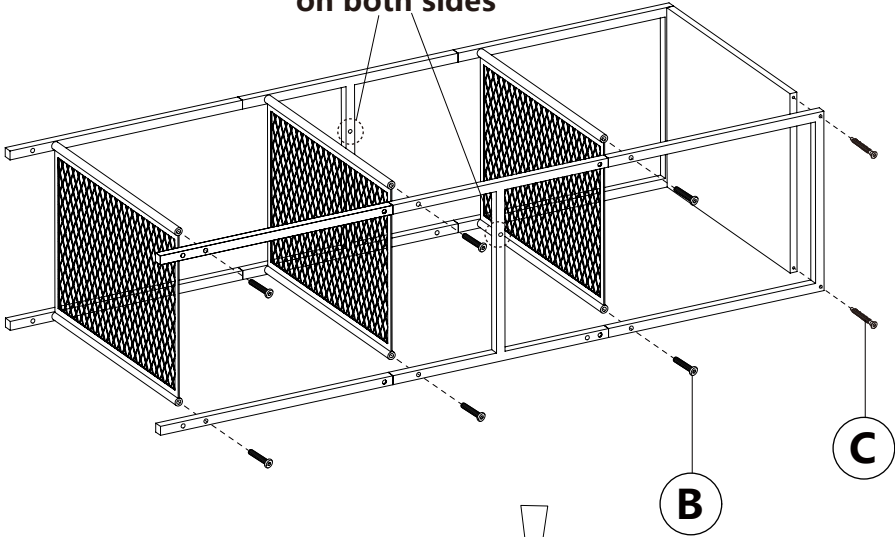

★ **Align the holes  
on both sides**

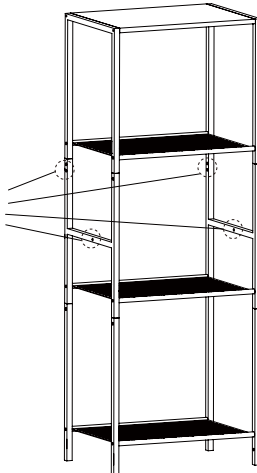

# Choose your preferred option

Option I

Left side



Option II

Right side

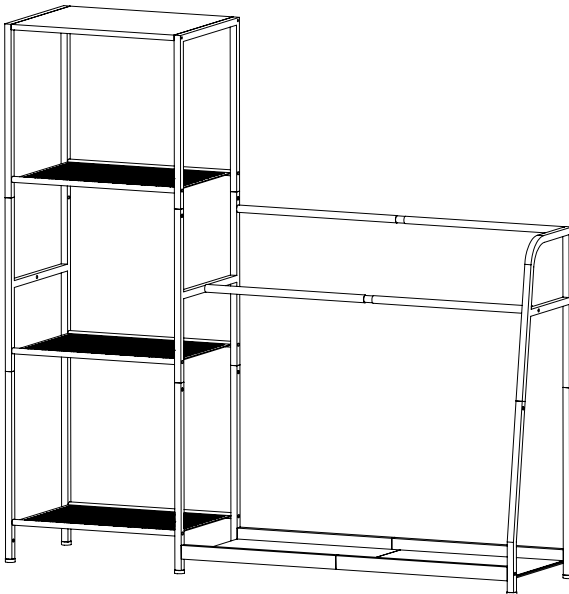

# Installation example for Option I (Left side)

**STEP 7**

**B** x 4



M6\*30mm Screw

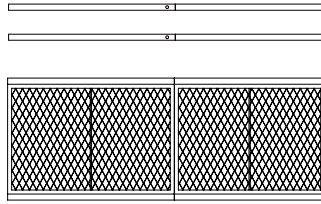

Use the "STEP 3" and "STEP 4" parts

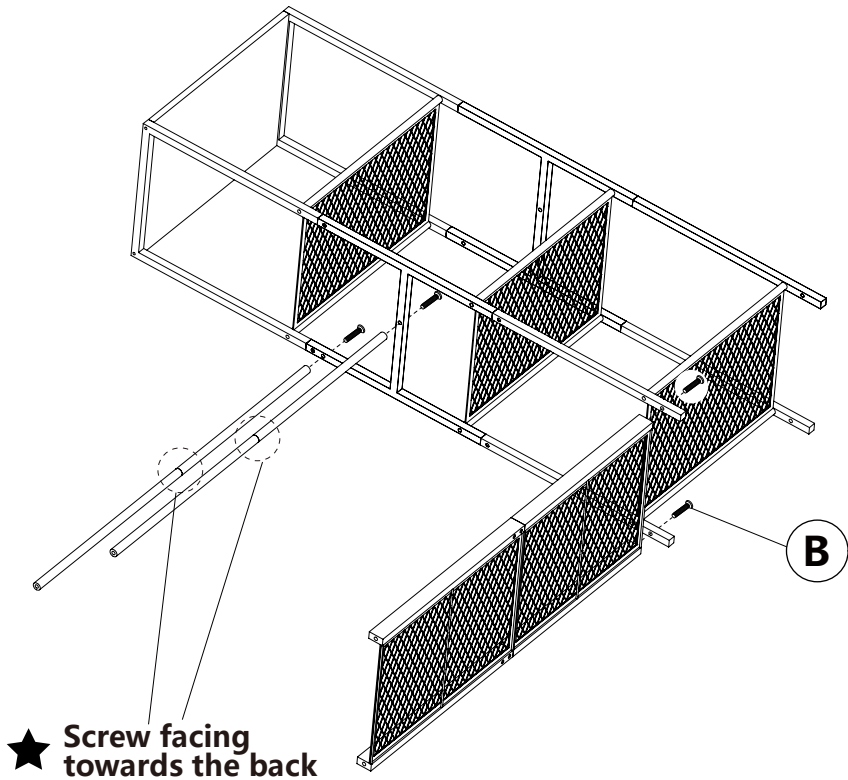

**STEP 8**

**B x 4**

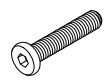

M6\*30mm Screw

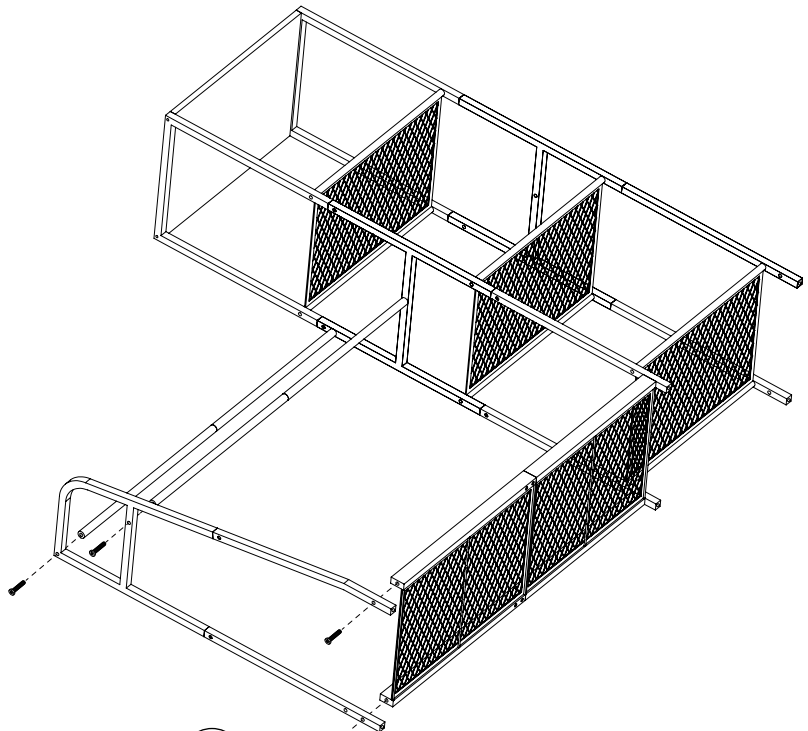

**B**

★ **Must be this hole**

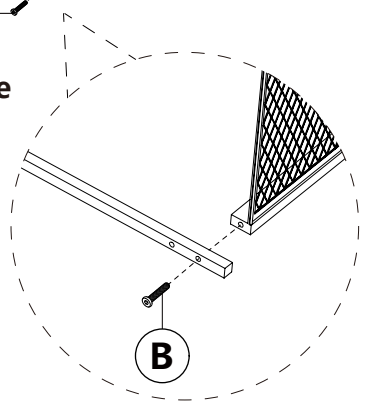

**STEP 9**

**D x 6**



Foot Pad

★ **Screw facing towards the back**

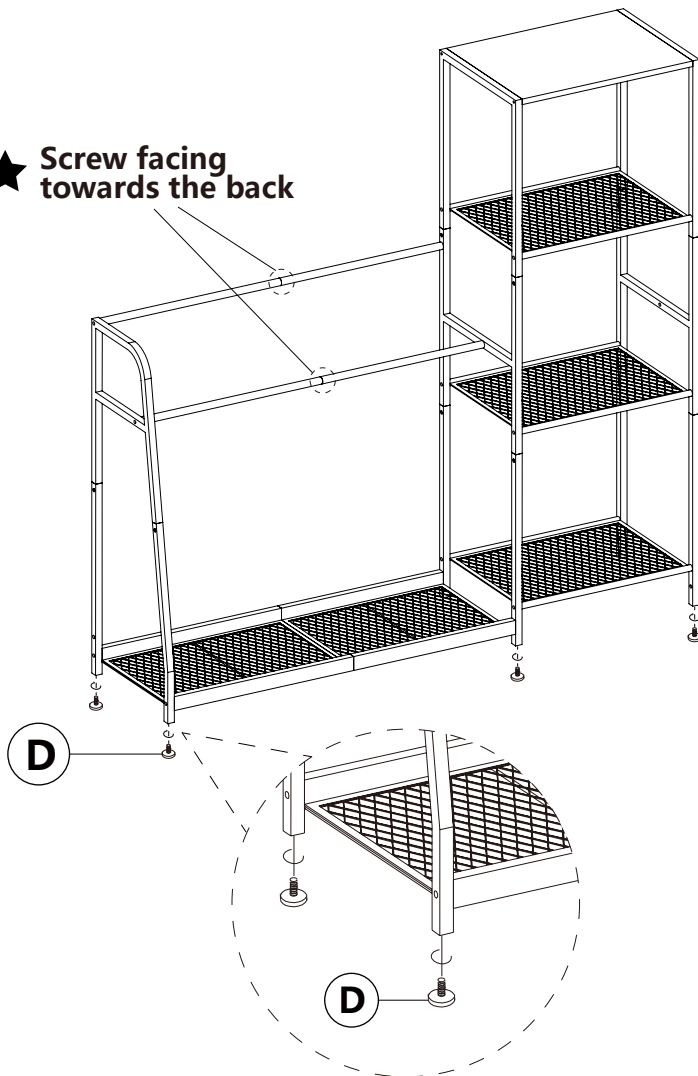

**STEP 10**

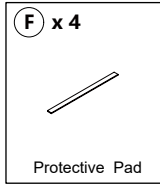
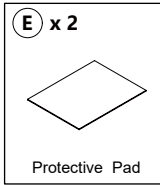

★ **Facing the front**

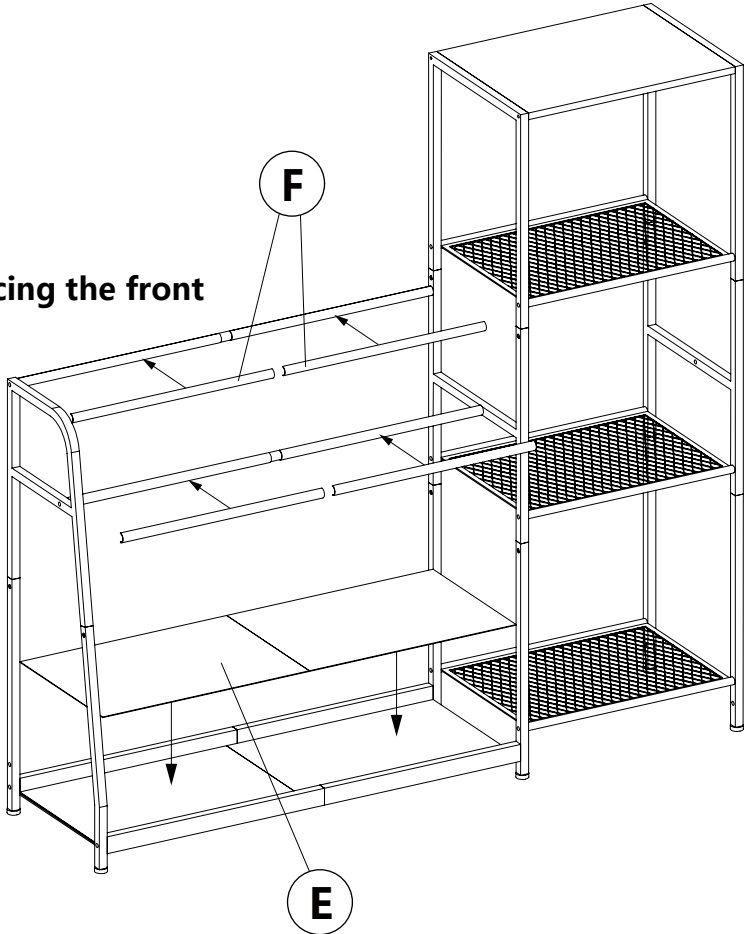

**E**  
**Align bottom**

STEP 11

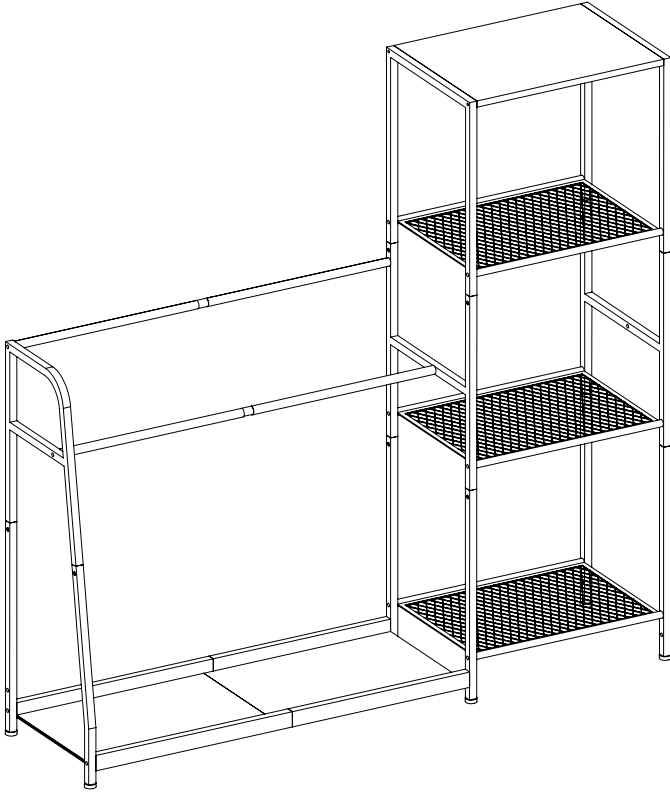

Finished

