

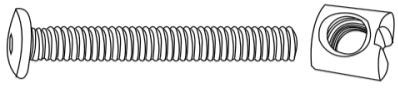

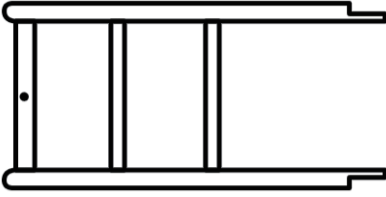







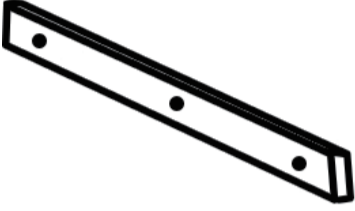

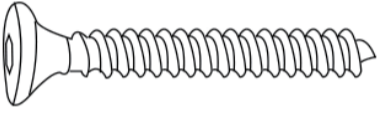
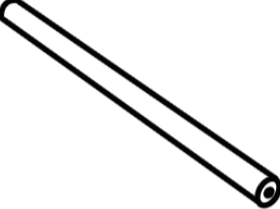
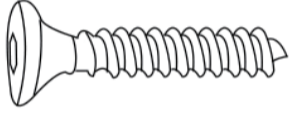
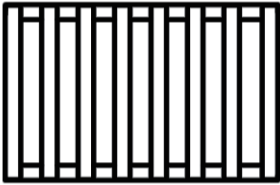
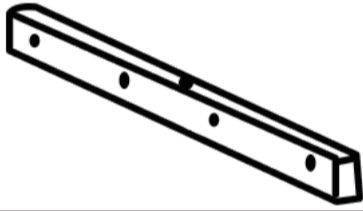

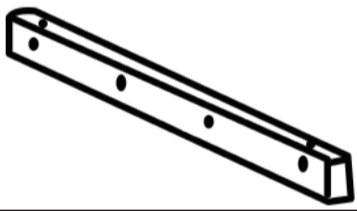
# Components List

Note: Please sort all the spare parts before installation to avoid confusion.

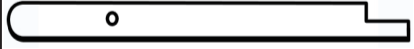
Code	Picture	Name	Quantity	Code	Picture	Name	Quantity
1#		Long Copper Color Screws +Inner Nuts	3 PCS	H		Storage Rack	1 PCS
2#		Middle Copper Color Screws	8 PCS	I		Bottom Rail	1 PCS
3#		Short Copper Color Screws	4 PCS	J		Arc Angle Bracket	1 PCS
4#		Sliver Long Pointed Screws	22 PCS	K		Clothes Hanging Rod	1 PCS
5#		Sliver Short Pointed Screws	4 PCS	L		Storage Laminate	2 PCS
A		5-Hole Bottom Bracket	1 PCS	M		Diagonal Bracing	2 PCS
B		6-Hole Bottom Bracket	1 PCS	N		Hook	6 PCS
C		Bottom Long Rail	4 PCS	O		Small Cork	6 PCS
D		Long Bracket	1 PCS			Universal Wheel	5 PCS
E		Short Bracket	1 PCS			Universal Wheel Wrench	1 PCS
F		Pants Rack (Above )	1 PCS			Wrench	1 PCS
G		Pants Rack (below )	1 PCS				

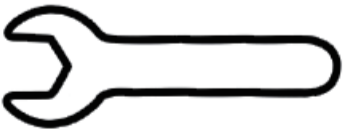
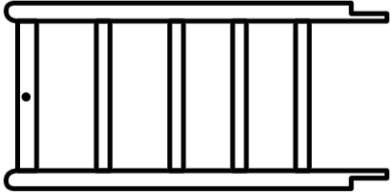
# Installation steps

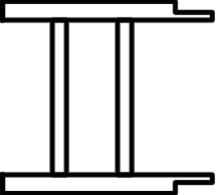
## Step 1

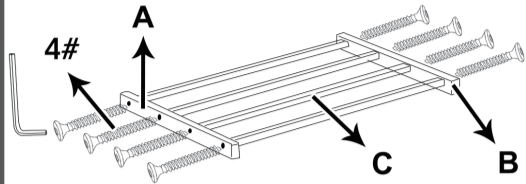

Inset 8pcs Screws(4#) into A and B to connect C

## Step 2

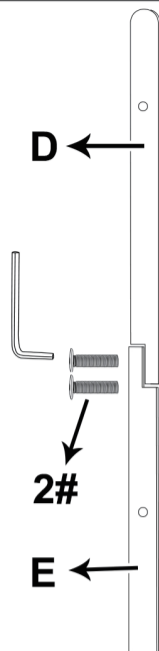

Connect D and E with 2pcs (2 #) screws

## Step 3

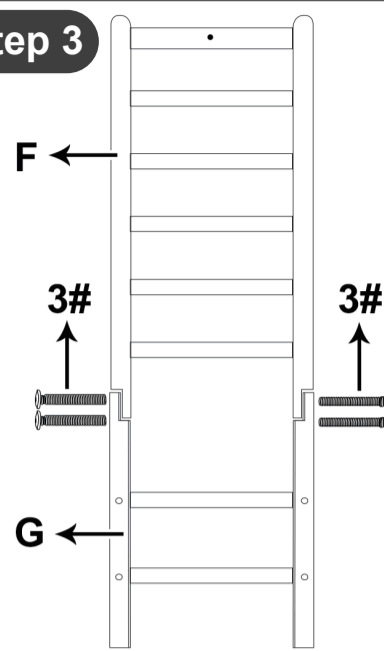

Connect F and G with 4pcs screws (3#)

## Step 4

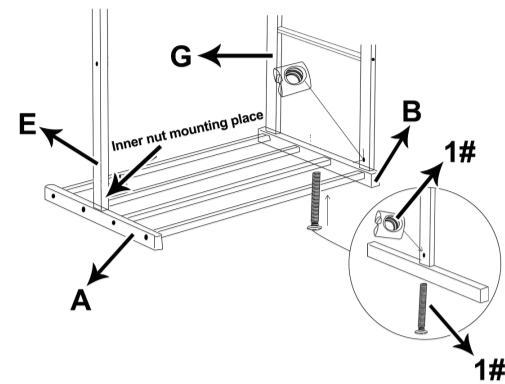

Use 3pcs long screws (1#) to install E on A, G and B. The inner nut is installed on the side of the rack, connected and tightened with the bottom screws as picture

## Step 5

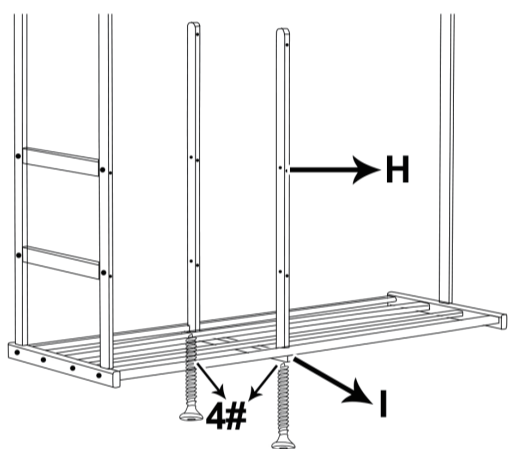

Inset 2pcs screws(4#) to connect H and I as shown (do not tighten the screws at once,needs to adjust the position in the step 8 according to installation needs)

## Step 6

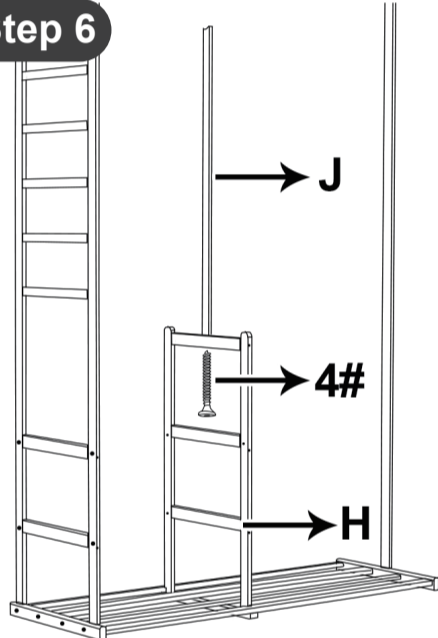

Use 1 pc screw(4#) to install J on H.

## Step 7

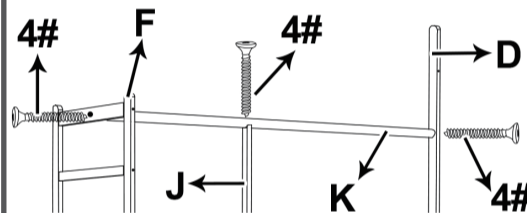

Install K on F and D with 2pcs screws (4#), and fix it on J with 1pc screws (4#)

## Step 8

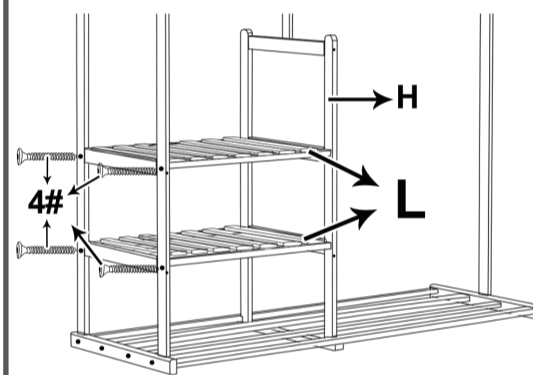

Install two L on H and G with 8 pcs screws (4#)

## Step 9

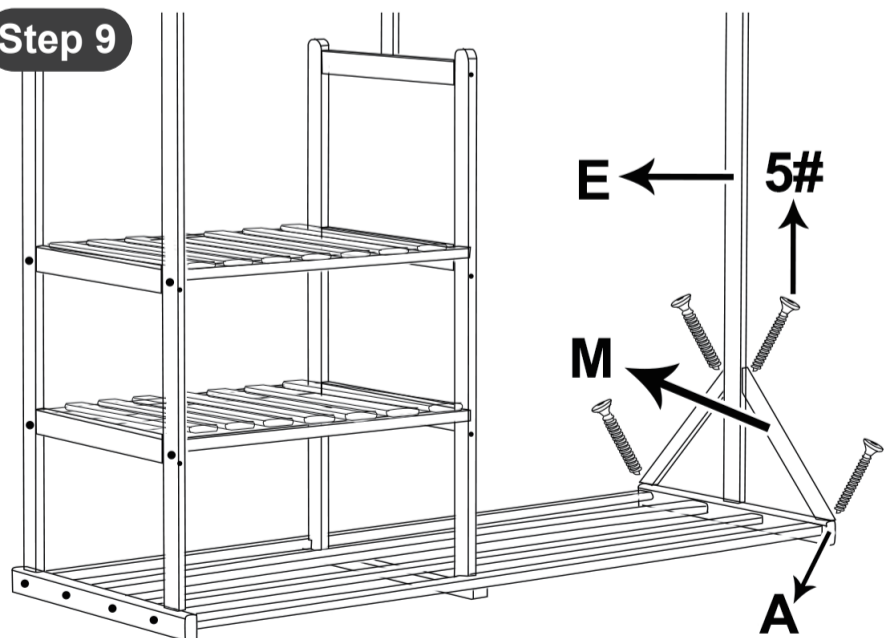

Use 4pcs screws (5#) to install M on A and E

## Step 10

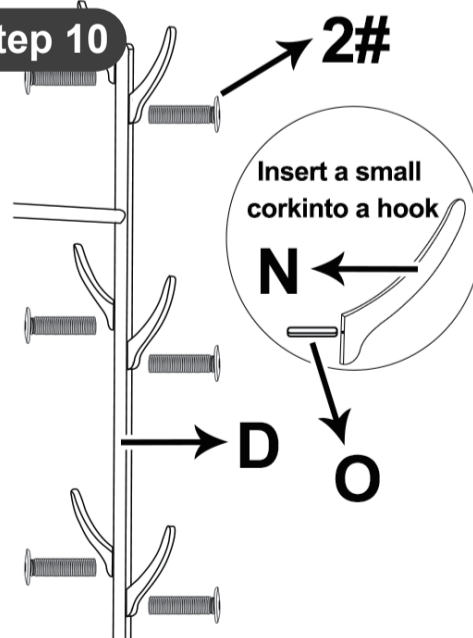

Connect O to N (total of six), and then use 6pcs screws (2#) to connect them to D

## Step 11

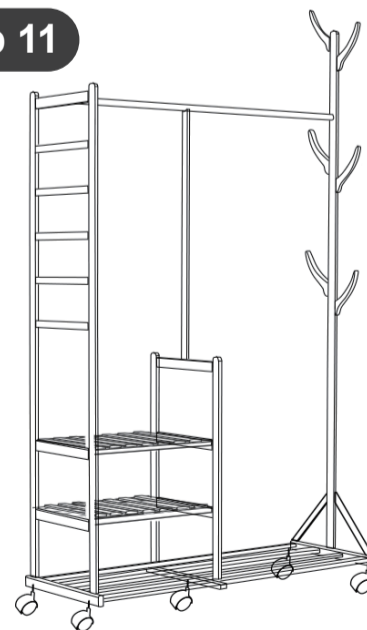

Use a universal wheel wrench to install the five universal wheels on the bottom of garment rack and tighten