

ASSEMBLY INSTRUCTION

COMPONENT PARTS

FITTINGS

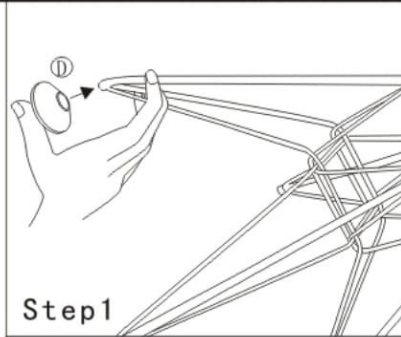
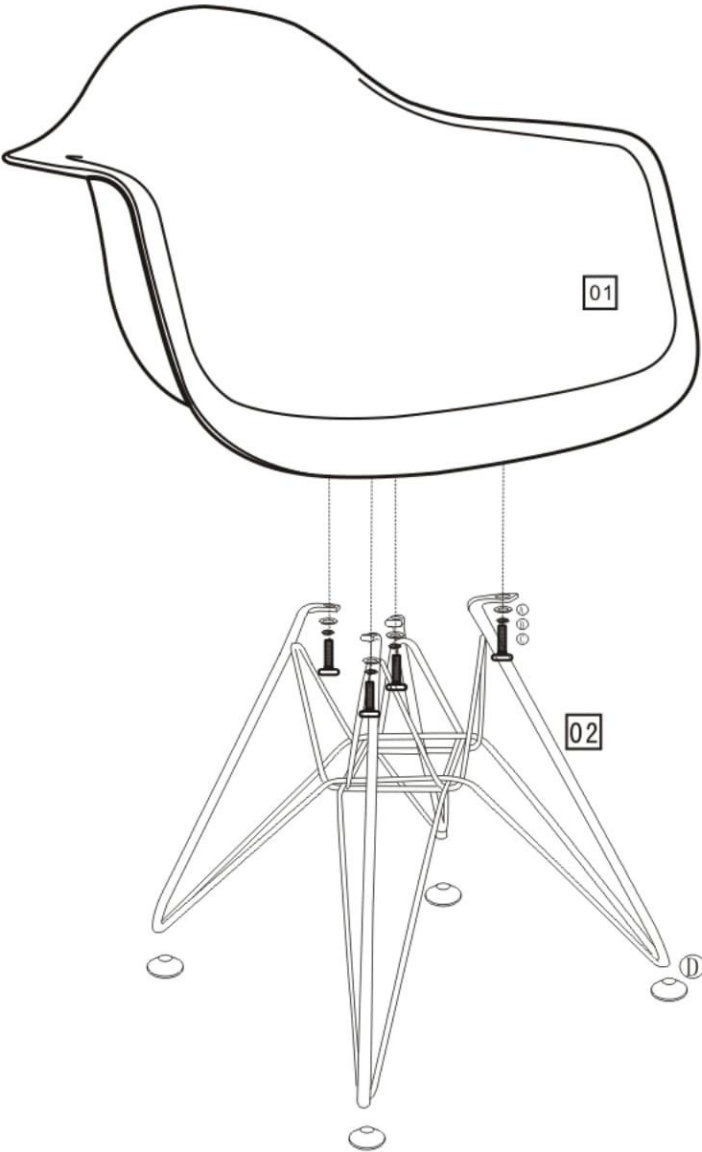

Step1

Slide the plastic cap onto the metal bar from the side (please do not force the cap from top by hammer)

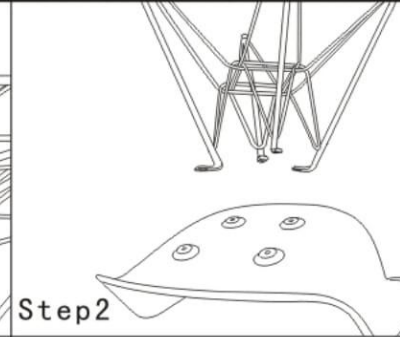

Step2

Please place the seat and the feet upside down

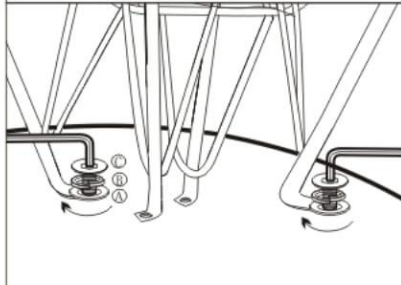

Step3

Please put 2 screws diagonally and rotate them into the holes loosely. (A) should go closest to the chair. (B) should go closest to the head of the bolt. Please be kindly noted that we can not tighten the screws at the moment.

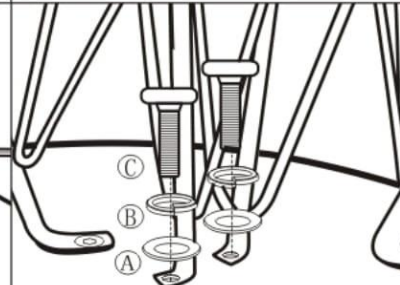

Step4

Please load the remaining 2 screws also diagonally





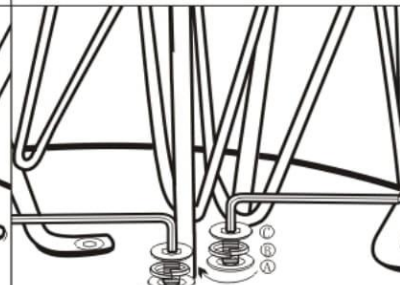

Step5

Please push the metal bars on the shell until the holes match with each other

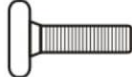

Step6

Tighten these 2 screws together with the previous 2 screws.

- (A)  X4
Regular washer
- (B)  X4
Lock washer
- (C)  X4
Bolt
- (D)  X4
Plastic cap

COMPONENT CHECKLIST

PART	No.	Qty.	
Seat	01	1	<input type="checkbox"/>
tube	02	1	<input type="checkbox"/>

TOOLS REQUIRED



Allen key (supplied)