



**INSTRUCTIONS D'ASSEMBLAGE
ASSEMBLY INSTRUCTIONS**

**TABLE D'APPOINT -
25"H / FAUX PIERRE GRIS / METAL NOIR**



**ACCENT TABLE -
25"H / GREY STONE-LOOK / BLACK METAL**



**POUR DE L'ASSISTANCE OU POUR COMMANDER
DES PIÈCES CONTACTEZ NOTRE DÉPARTEMENT
DE SERVICE À LA CLIENTÈLE.**

**FOR ASSISTANCE OR TO ORDER PARTS
CONTACT OUR CUSTOMER SERVICE DEPARTMENT**

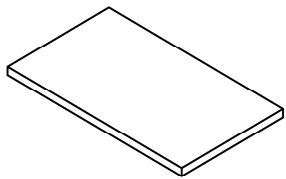
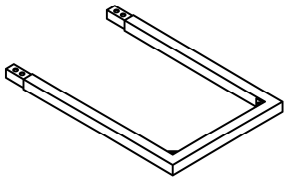
LISTE DES PIÈCES
PARTS LIST

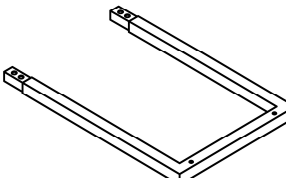
PIÈCE / PART #	IMAGE	DESCRIPTION	QTY / QTÉ
1		<p>TABLE TOP SURFACE DE TABLE</p>	1
2		<p>TOP FRAME CADRE DE SURFACE</p>	1
3		<p>SIDE FRAME CADRE DE CÔTÉ</p>	1
4		<p>BOTTOM FRAME CADRE DU BAS</p>	1

LISTE DES PIÈCES DE MONTAGE
HARDWARE LIST

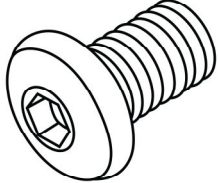
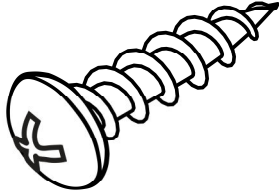
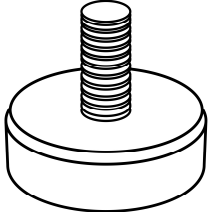
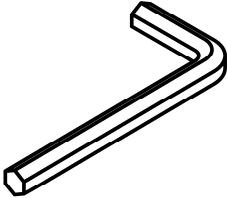
PIÈCE / PART #	IMAGE	DESCRIPTION	QTY / QTÉ
A		ASSEMBLING BOLT - Ø 1/4" X 1/2" BOULON D'ASSEMBLAGE - Ø 1/4" X 1/2"	8
B		ASSEMBLING SCREW - Ø 1/8" X 1/2" VIS D'ASSEMBLAGE - Ø 1/8" X 1/2"	4
C		ADJUSTABLE LEG PATTE AJUSTABLE	4
D		HEX KEY CLÉ HEXAGONALE	1



OUTIL DE VÉRIFICATION DE DIMENSIONS DES PIÈCES
HARDWARE DIMENSIONS VERIFICATION TOOL

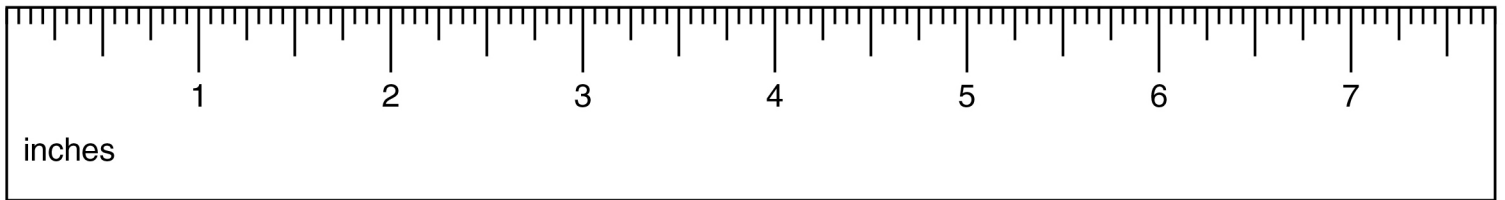

ÉTAPE / STEP 1

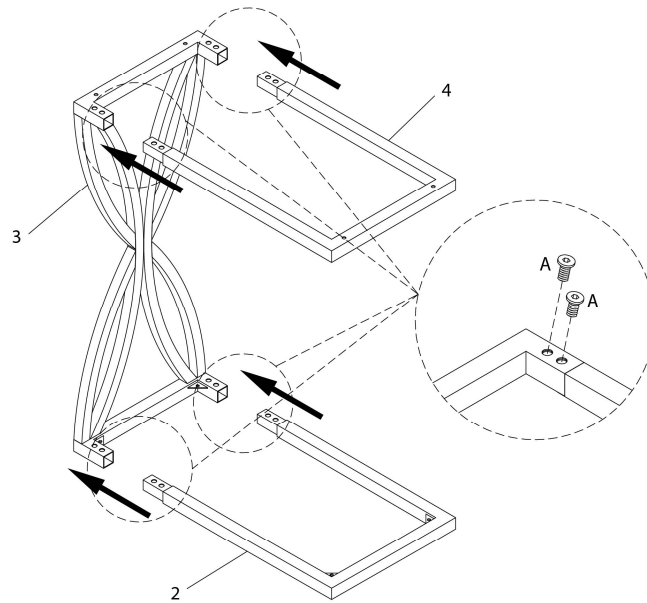

ÉTAPE / STEP 2

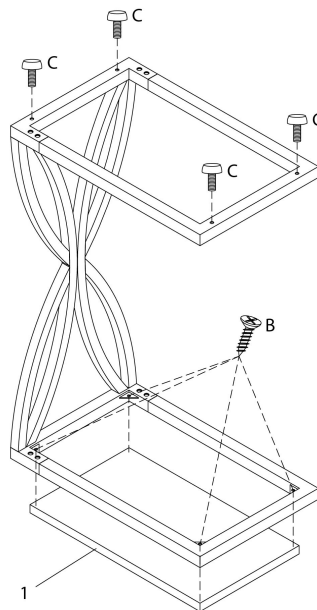

ÉTAPE / STEP 3

