

For the RHF Bed Series

ASSEMBLY INSTRUCTION

Arched Ball-Finial Steel Tube Bed

- **Twin/Twin XL** [CLICK HERE](#)
(01/02)
- **Full/Queen** [CLICK HERE](#)
(03/04)
- **KING/Cal KING** [CLICK HERE](#)
(05/06)



For the RHF Bed Series

ASSEMBLY INSTRUCTION

Arched Ball-Finial Steel Tube Bed

RHF320XC-14A

Size: Twin/Twin XL(01/02)



Applicable to the Following Series Simultaneously :

RHF320XC-18A



★ You can contact us via the marketplace [order message center](#) for any product questions. We will reply within 24 hours. Thanks for your support!

Please Read Before Assembly

Read Before Beginning Assembly:

Clearing a area: Please assemble in a spacious area near the product's final location, preferably on a carpet or protected surface to safeguard both your floor and the product.

Team assembly is recommended: It is recommended that 2 people assemble this product. Having an extra hand can make the process faster and easier.

Check for all parts: Most parts are labeled or stamped on the raw edge.

Ensure all parts are included before starting.

Read each step carefully: Follow the assembly steps in the correct order.

Skipping steps or changing the sequence can lead to difficulties.

Caution:

Choking Hazard: This product contains small parts. Keep them away from children under 3 years old. Children under 4 years old must be supervised by adults when near the bed.

Warranty Information:

This product is warranted against defects in materials and manufacture for 5 years from the purchase date (proof of purchase required).

Warranty covers defective parts only. Assembly labor not included.











Not valid for misuse, improper assembly, alterations, or unauthorized repairs.

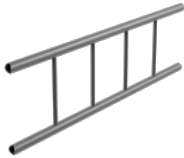











No liability for consequential damages where permitted by law.

Notice:

Do not jump, roughhouse, or engage in strenuous activities on the bed, as this may cause personal injury or damage to the bed frame.

- ★ In case of missing or damaging parts, please provide your order number and the name of the required part to apply for a replacement.
- ★ Power tools are prohibited for installation, as they may cause thread stripping.
- ★ Do not fully tighten any screws until the entire assembly is completed. This allows for proper alignment and adjustments during the assembly process. Tightening them all at the end will result in a more stable structure.

					
①x2 Side Bracket	②x1 Connector bent pipe	③x2 Bracket	④x2 Headboard Post	⑤x1 Connector pipe	⑧x1 Center Support Bar
				①x2 : Part ①, 2 PCS. M6*48 : An M6 - sized screw with a length of 48mm.	
⑩x10 Slat	⑪x2 Footboard Post	⑬x8 Connector Part B	⑰x2 Mattress Gasket	Legend	

							B x 1 D x 1 F x 1 G x 1 I x 1 J x 1
H x 1 PCS 4mm	F x 4	G x 4	F x 4	G x 4	D x 8	A x 2	
							
	I x 4	J x 4	I x 4	J x 4	B x 8		
Tool	Step 1	Step 2	Step 3	Step 4	Spare		

Step-by-step opening - no all-at-once.

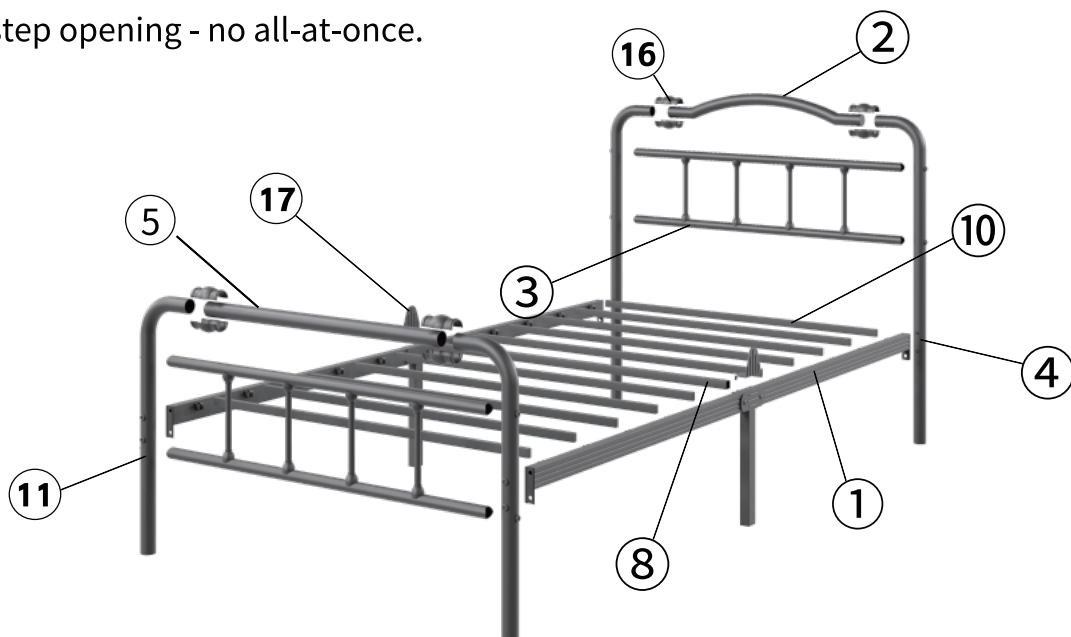

BACK

★ This product only includes the parts numbered above, and the missing numbers are not used in this product.

Step 1-1

Assemble Headboard:

1. Connect the headboard posts ④ and the brackets ③ with bolts (I) and washers (J).

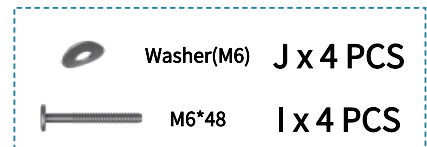
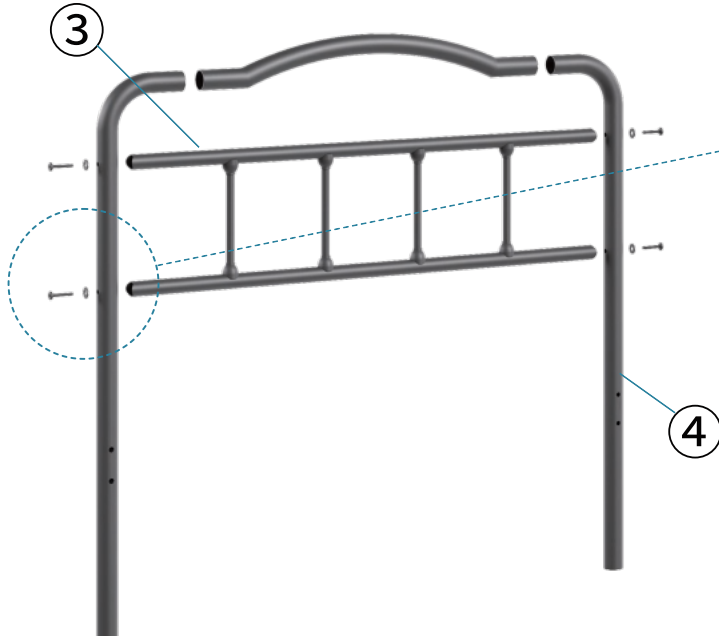

Step 1-2

Assemble Headboard:

1. Connect the bolt (F) and the nut(G) through the connector part B ⑩, the connector pipe ②, and the bed posts as shown in the figure.

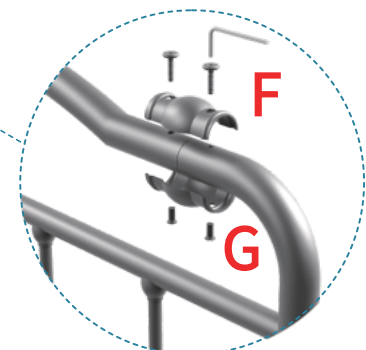
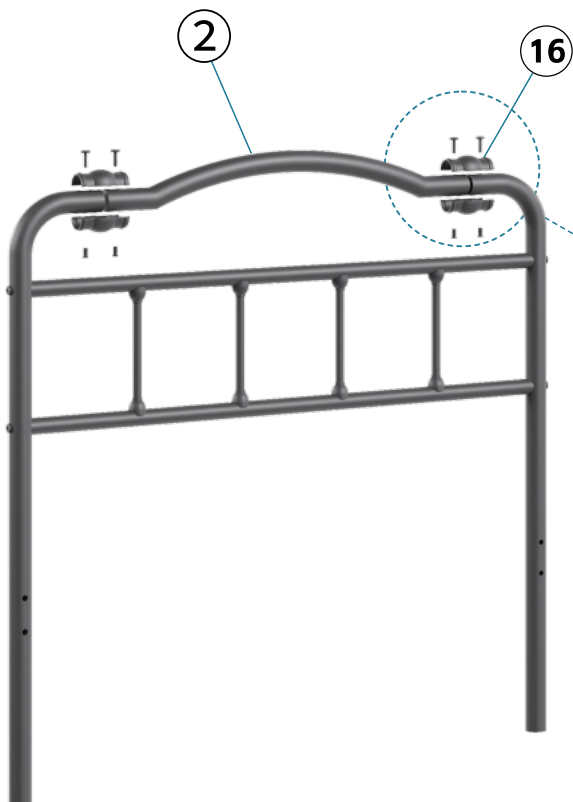

Step 2

Assemble Footboard :

1. Refer to Step 1 of the headboard assembly to assemble the footboard as shown in the figure.

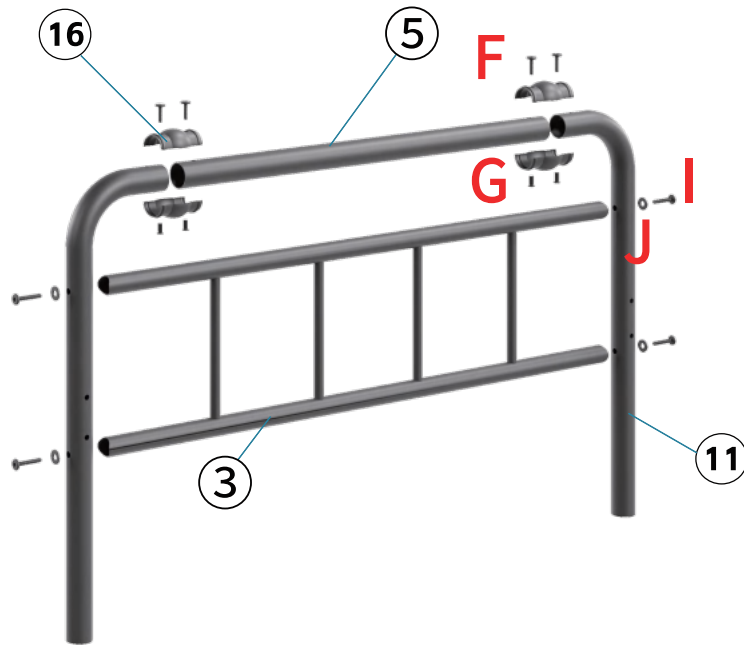

	Washer(M6)	J x 4 PCS
	M6*48	I x 4 PCS
	M6*26	F x 4 PCS
	M6*16	G x 4 PCS

Step 3

Assemble the Side Brackets :

1. Unfold the side brackets ①;
2. Connect the side brackets ① and the bed posts ④ & ⑪ with bolts (B) and washers (D).

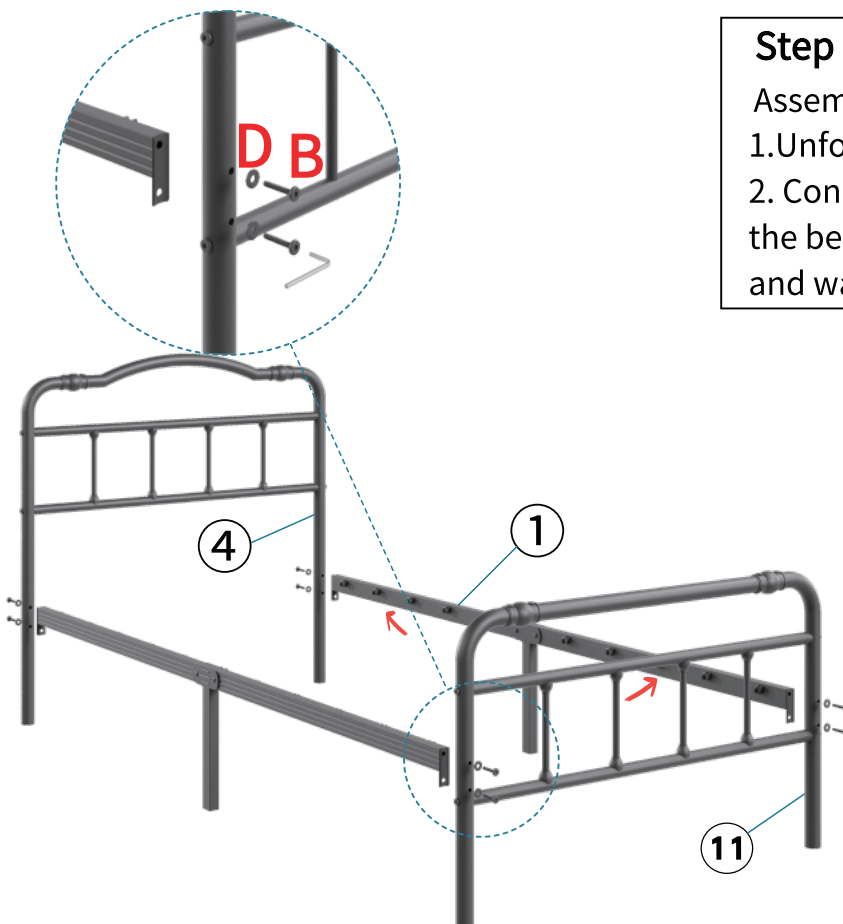

	Washer (M8)	D x 8 PCS
	M8*48	B x 8 PCS

Step 4

Assemble the Center Support Bar :

1. Assemble the center support bar ⑧ and the mattress gaskets ⑰ with bolts (A) as shown in the figure.

(⑰ can be installed or not. Pull the two bottom claws of the retainer outward to fully seat against the side rail, then tighten screws to avoid wobble.)

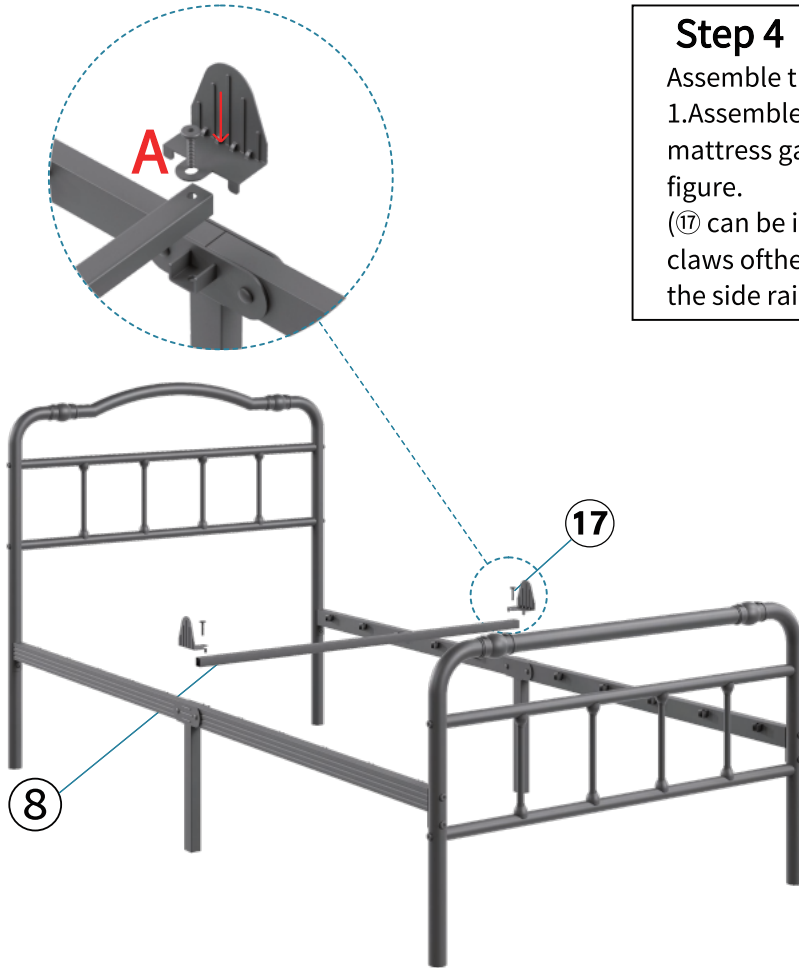

M8*35

A x 2 PCS

Step 5

Install the Slats ⑩ as shown.

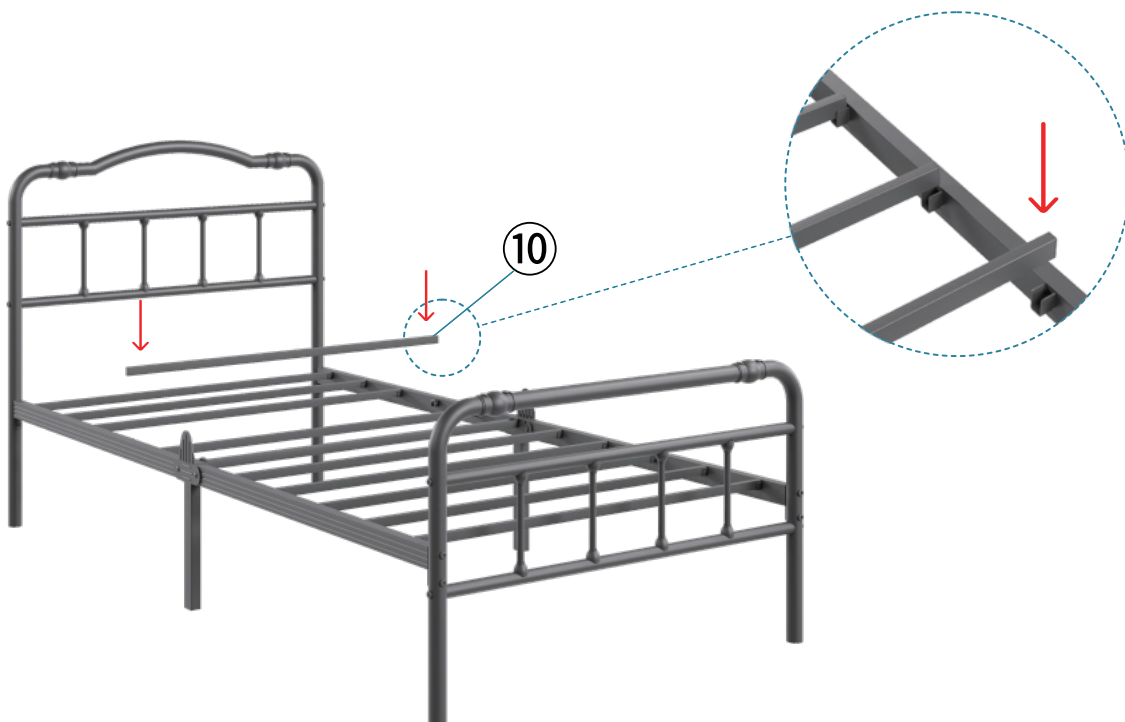

Note:

Check the tightness of all screws, retighten them, and ensure the structure is stable.

Reminder:

Regularly inspect the tightness of screws every 6 months. Retighten any loose ones promptly to maintain stability.

Cleaning & Care:

Use a dry or slightly damp soft cloth for cleaning. Avoid abrasive cleaners and corrosive substances (e.g., alcohol, bleach) to protect the product's finish. Regularly wipe off dust to extend service life.”

Please keep these instructions for future reference!

BACK

BACK

For the RHF Bed Series

ASSEMBLY INSTRUCTION

Arched Ball-Finial Steel Tube Bed

RHF320XC-14A

Size: Full/Queen(03/04)



Applicable to the Following Series Simultaneously :

RHF320XC-18A



You can contact us via the marketplace [order message center](#) for any product questions. We will reply within 24 hours. Thanks for your support!

Please Read Before Assembly

Read Before Beginning Assembly:

Clearing a area: Please assemble in a spacious area near the product's final location, preferably on a carpet or protected surface to safeguard both your floor and the product.

Team assembly is recommended: It is recommended that 2 people assemble this product. Having an extra hand can make the process faster and easier.

Check for all parts: Most parts are labeled or stamped on the raw edge. Ensure all parts are included before starting.

Read each step carefully: Follow the assembly steps in the correct order.

Skipping steps or changing the sequence can lead to difficulties.

Caution:

Choking Hazard: This product contains small parts. Keep them away from children under 3 years old. Children under 4 years old must be supervised by adults when near the bed.

Warranty Information:

This product is warranted against defects in materials and manufacture for 5 years from the purchase date (proof of purchase required).

Warranty covers defective parts only. Assembly labor not included.















Not valid for misuse, improper assembly, alterations, or unauthorized repairs.

















No liability for consequential damages where permitted by law.

Notice:

Do not jump, roughhouse, or engage in strenuous activities on the bed, as this may cause personal injury or damage to the bed frame.

- ★ In case of missing or damaging parts, please provide your order number and the name of the required part to apply for a replacement.
- ★ Power tools are prohibited for installation, as they may cause thread stripping.
- ★ Do not fully tighten any screws until the entire assembly is completed. This allows for proper alignment and adjustments during the assembly process. Tightening them all at the end will result in a more stable structure.

				
①x2 Side Bracket	④x2 Headboard Post	⑤x4 Right bracket	⑥x1 Center Support Rail	⑧x1 Center Support Bar
				
⑩x20 Slat	⑪ x2 Footboard Post	⑫ x1 Footboard Center Post	⑬ x2 Connector Pipe	⑭ x1 Headboard Center Post
				①x2 : Part ①, 2 PCS. M6*10 : An M6 - sized screw with a length of 10mm.
⑮x2 Connector Part A	⑯x10 Connector Part B	⑰ x2 Mattress Gasket	⑱ x2 Connector bent pipe	
				Legend

 H x 1PCS 4mm	 E x 4  F x 7  G x 6  J x 4  I x 4	 E x 4  F x 7  G x 6  J x 4  I x 4	 B x 8  D x 8	 A x 4	 A x 2  C x 1	B x 1 D x 1 E x 1 F x 1 G x 1 I x 1 J x 1
Tool	Step 1	Step 2	Step 3	Step 4	Step 5	Spare

Step-by-step opening - no all-at-once.

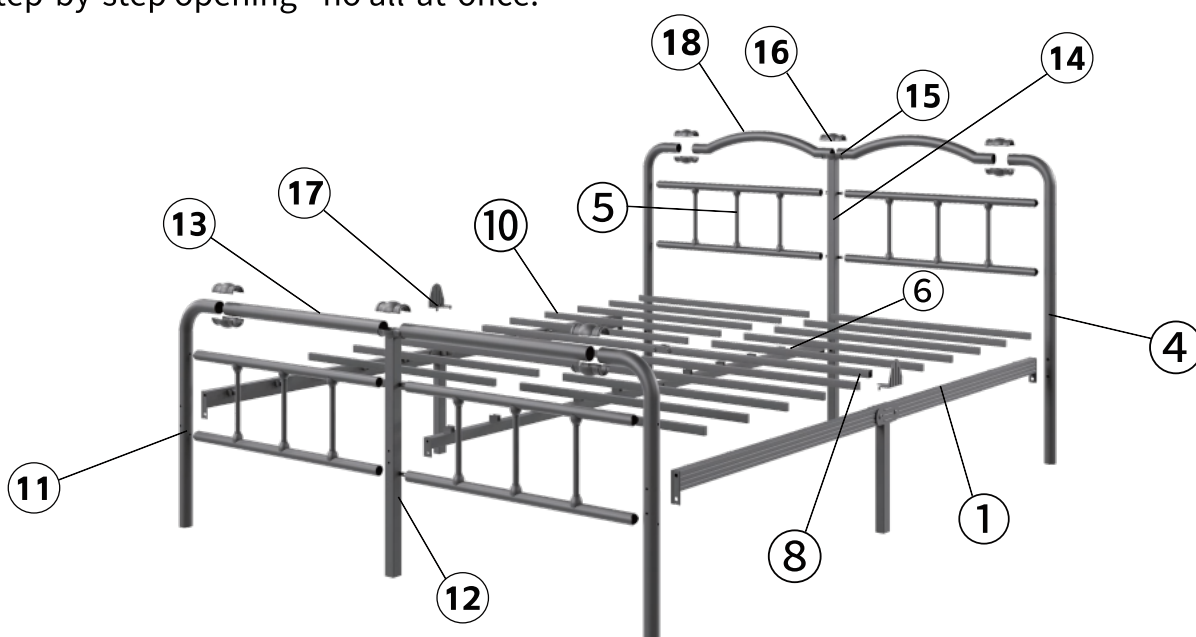

BACK

★ This product only includes the parts numbered above, and the missing numbers are not used in this product.

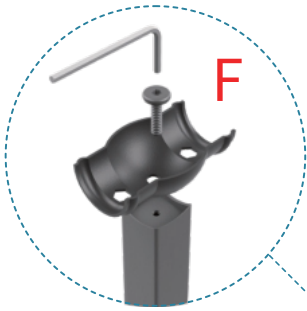



Step 1-1

Assemble Headboard:

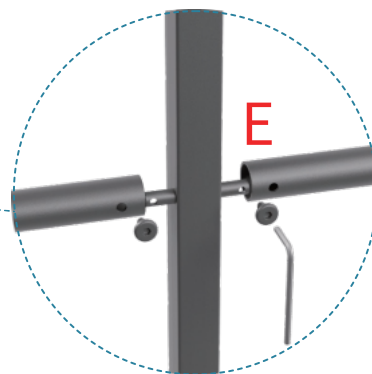
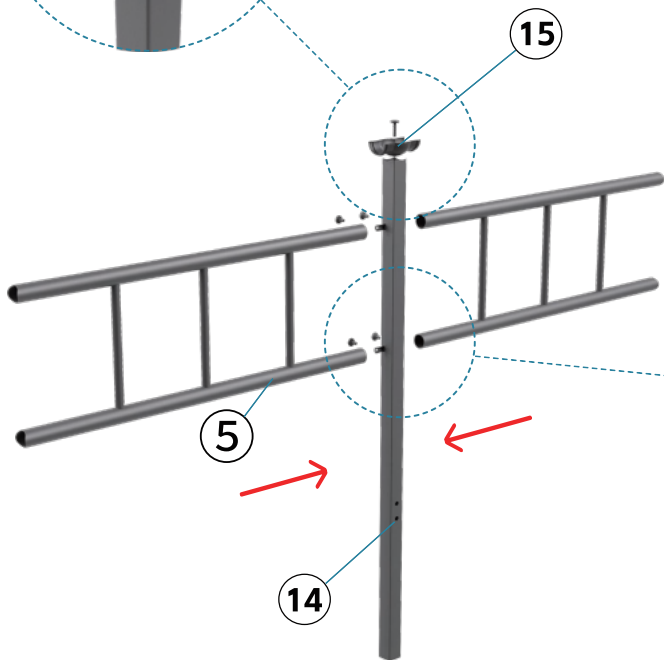
1. Tighten the headboard center post ⑭ and the connector part A ⑮ with bolts (F).
2. Connect the brackets ⑤ and the headboard center post ⑭ with bolts (E).



	M6*10	E x 4 PCS
	M6*26	F x 1 PCS

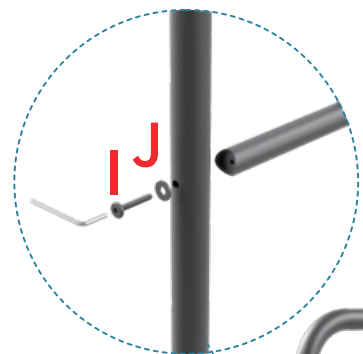



Step 1-2

Assemble Headboard:

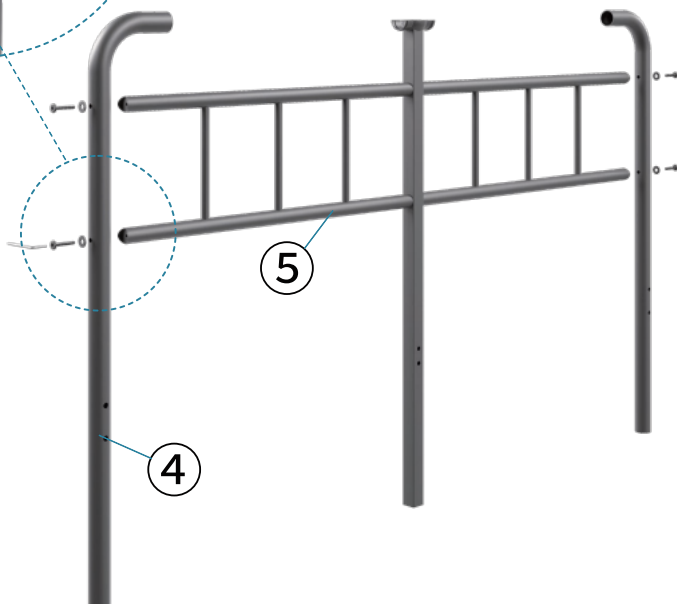
1. Connect the headboard posts ④ and the brackets ⑤ with bolts (I) and washers (J).





	Washer (M6)	J x 4 PCS
	M6*48	I x 4 PCS

Step 1-3

Assemble Headboard :

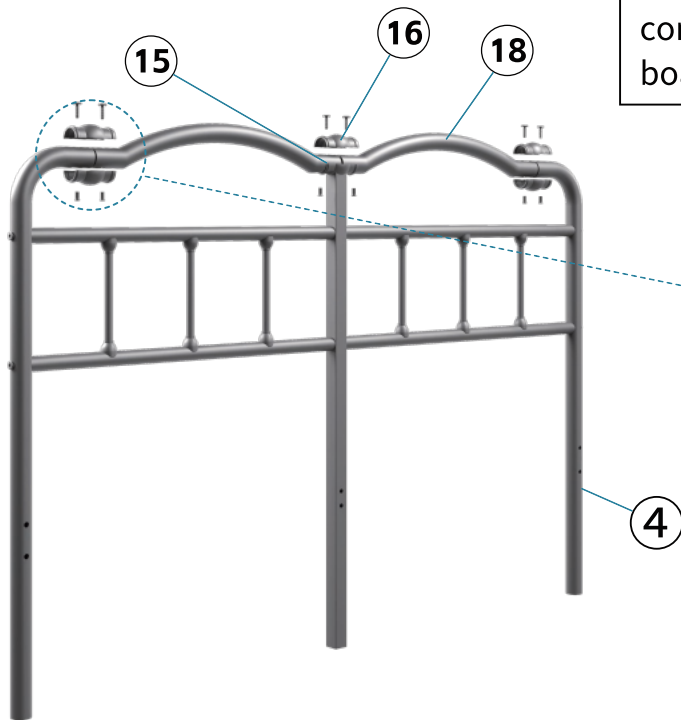
1. Connect the bolt (F) and the nut (G) through the connector part B (16), the connector bent pipe (18), and the headboard posts (4) as shown in the figure.



	M6*26	F x 6 PCS
	M6*16	G x 6 PCS

Step 2

Assemble the Footboard :

1. Refer to Step 1 of the headboard assembly to assemble the footboard as shown in the figure.



	M6*10	E x 4 PCS
	M6*26	F x 7 PCS
	M6*16	G x 6 PCS
	Washer (M6)	J x 4 PCS
	M6*48	I x 4 PCS

Step 3

Assemble the Side Brackets :

1. Unfold the side brackets ①;
2. Connect the side brackets ① and the bed posts ④&⑪ with bolts (B) and washers (D) .

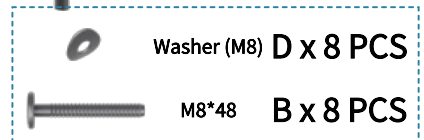
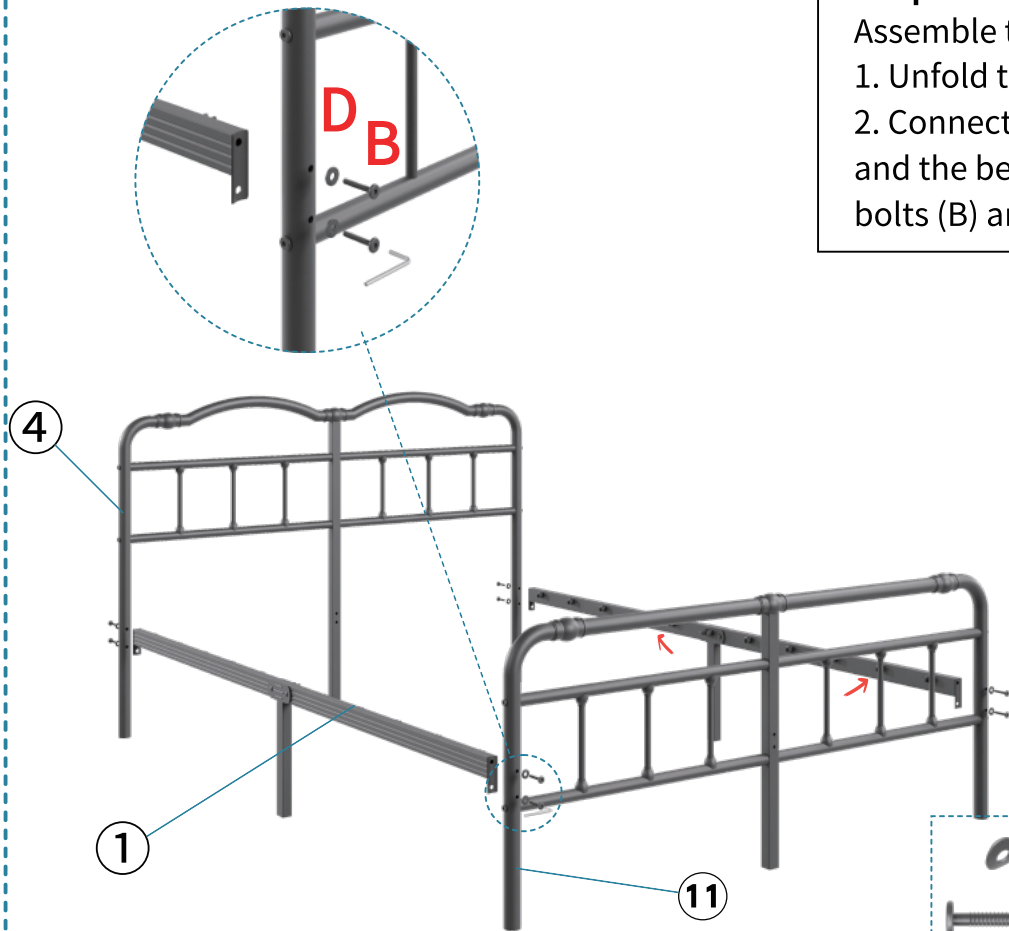

Step 4

Assemble the Center Support Rail

1. Unfold the center support rail ⑥ and assemble it with bolts (A) as shown in the figure.

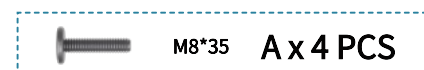
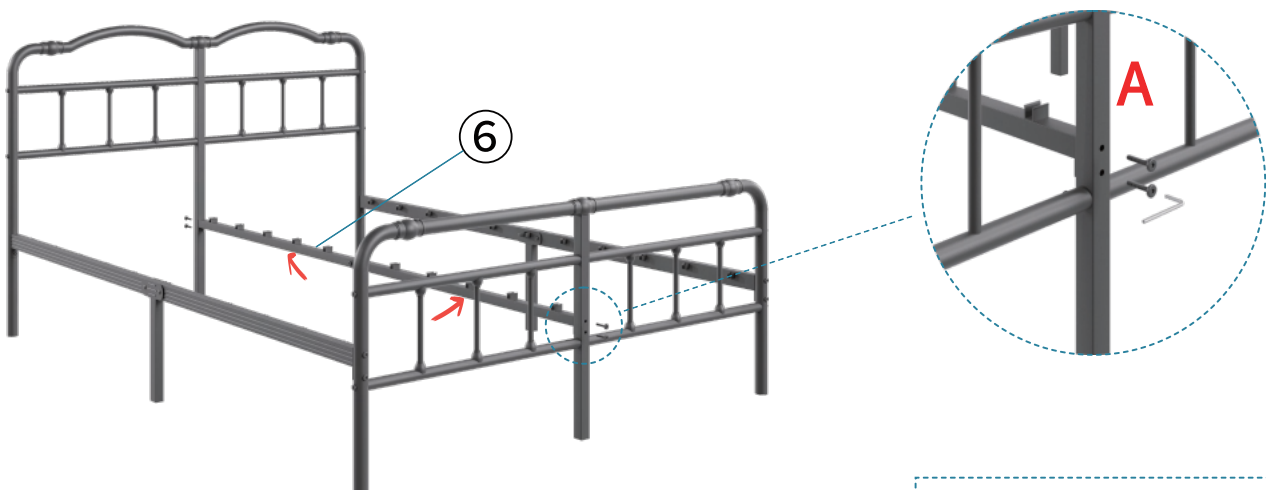



Step 5

Assemble Center Support Bar :

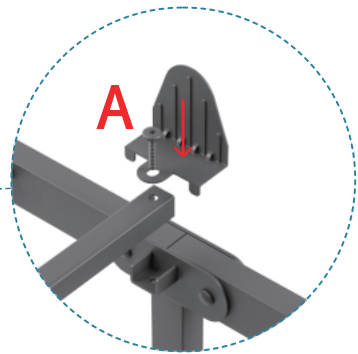
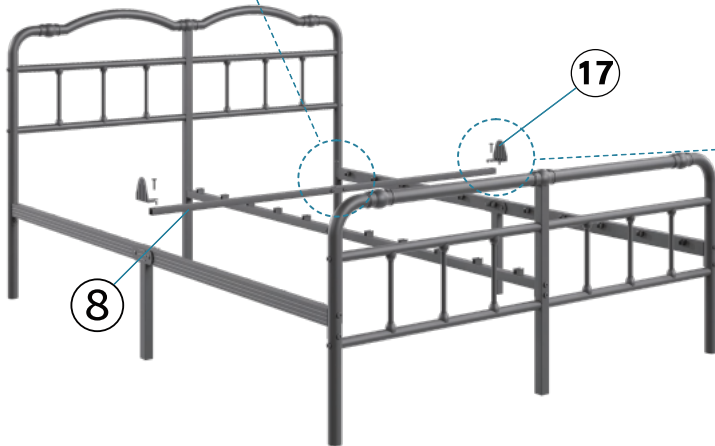
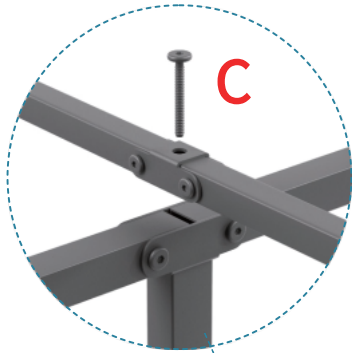
1. Unfold the center support bar ⑧;
 2. Assemble it and the mattress gasket ⑰ with bolts (A) as shown in the figure.
 3. Finally, assemble the middle position of the center support bar with bolt (C).
- (⑰ can be installed or not. Pull the two bottom claws of the retainer outward to fully seat against the side rail, then tighten screws to avoid wobble.)



	M8*35	A x 2 PCS
	M8*56	C x 1 PCS

Step 6

Install the Slats ⑩ as shown.

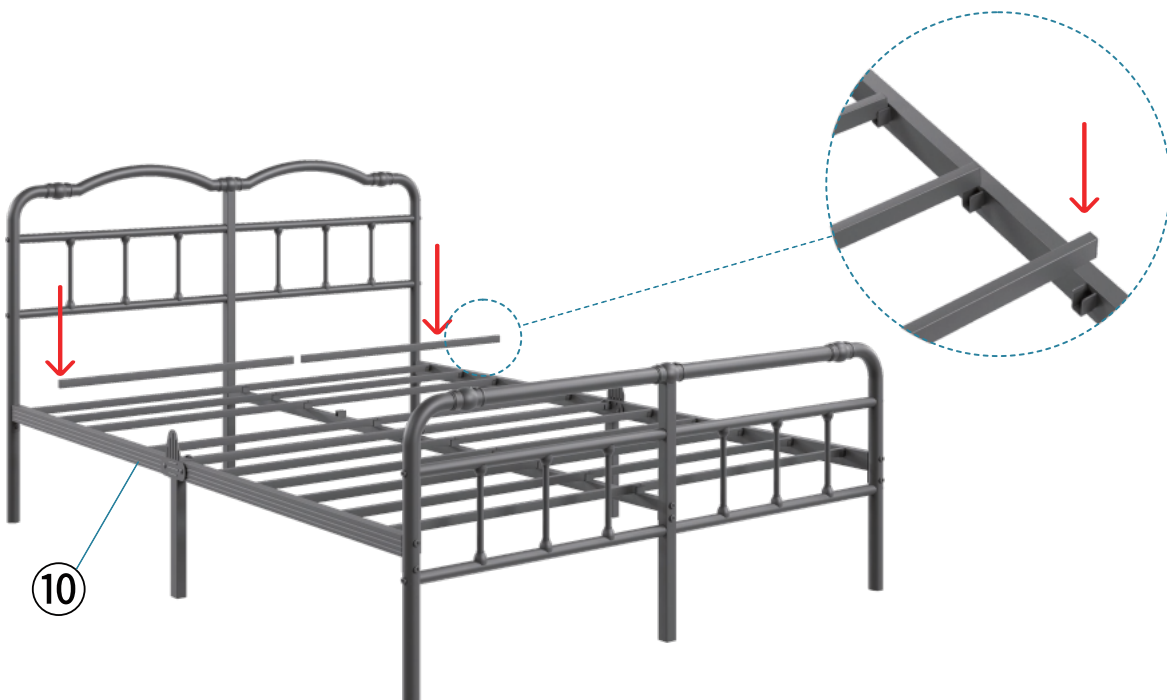

Note:

Check the tightness of all screws, retighten them, and ensure the structure is stable.

Reminder:

Regularly inspect the tightness of screws every 6 months. Retighten any loose ones promptly to maintain stability.

Cleaning & Care:

Use a dry or slightly damp soft cloth for cleaning. Avoid abrasive cleaners and corrosive substances (e.g., alcohol, bleach) to protect the product's finish. Regularly wipe off dust to extend service life.”

Please keep these instructions for future reference!

BACK

BACK

For the RHF Bed Series

ASSEMBLY INSTRUCTION

Arched Ball-Finial Steel Tube Bed

RHF320XC-14A

Size: King/Cal King(05/06)



Applicable to the Following Series Simultaneously :

RHF320XC-18A



You can contact us via the marketplace [order message center](#) for any product questions. We will reply within 24 hours. Thanks for your support!

Please Read Before Assembly

Read Before Beginning Assembly:

Clearing a area: Please assemble in a spacious area near the product's final location, preferably on a carpet or protected surface to safeguard both your floor and the product.

Team assembly is recommended: It is recommended that 2 people assemble this product. Having an extra hand can make the process faster and easier.

Check for all parts: Most parts are labeled or stamped on the raw edge. Ensure all parts are included before starting.

Read each step carefully: Follow the assembly steps in the correct order.

Skipping steps or changing the sequence can lead to difficulties.

Caution:

Choking Hazard: This product contains small parts. Keep them away from children under 3 years old. Children under 4 years old must be supervised by adults when near the bed.

Warranty Information:

This product is warranted against defects in materials and manufacture for 5 years from the purchase date (proof of purchase required).

Warranty covers defective parts only. Assembly labor not included.







Not valid for misuse, improper assembly, alterations, or unauthorized repairs.

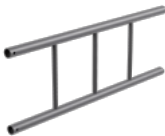

No liability for consequential damages where permitted by law.

Notice:

Do not jump, roughhouse, or engage in strenuous activities on the bed, as this may cause personal injury or damage to the bed frame.

- ★ In case of missing or damaging parts, please provide your order number and the name of the required part to apply for a replacement.
- ★ Power tools are prohibited for installation, as they may cause thread stripping.
- ★ Do not fully tighten any screws until the entire assembly is completed. This allows for proper alignment and adjustments during the assembly process. Tightening them all at the end will result in a more stable structure.

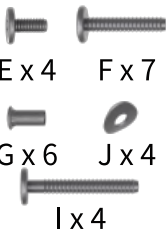
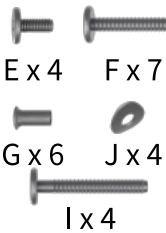
				
①x2 Side Bracket	④x2 Headboard Post	⑤x4 Right bracket	⑥x1 Center Support Rail	⑧x1 Center Support Bar
				
⑩x20 Slat	⑪ x2 Footboard Post	⑫ x1 Footboard Center Post	⑬ x2 Connector Pipe	⑭ x1 Headboard Center Post
				①x2 : Part ①, 2 PCS. M6*10 : An M6 - sized screw with a length of 10mm.
⑮x2 Connector Part A	⑯x10 Connector Part B	⑰x2 Mattress Gasket	⑱ x2 Connector bent pipe	
				Legenth

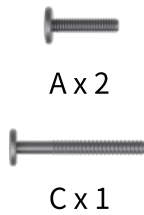
						B x 1 D x 1 E x 1 F x 1 G x 1 I x 1 J x 1
H x 1PCS 4mm	G x 6 J x 4 I x 4	G x 6 J x 4 I x 4	B x 8 D x 8	A x 4	A x 2 C x 1	
Tool	Step 1	Step 2	Step 3	Step 4	Step 5	Spare

Step-by-step opening - no all-at-once.

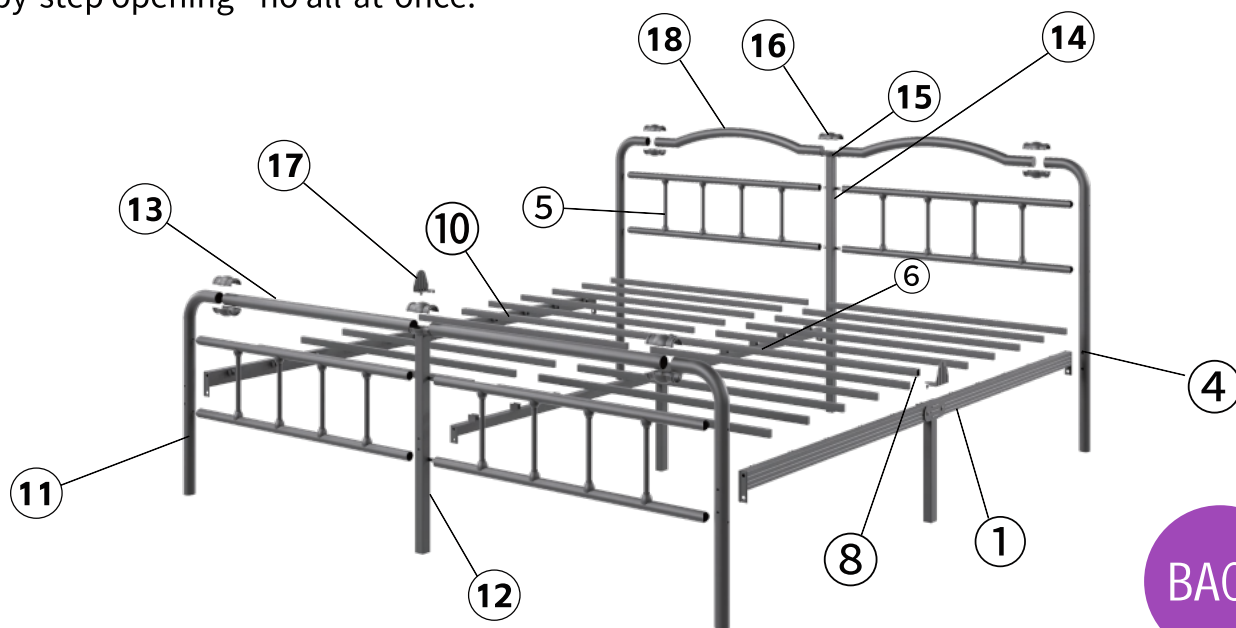

BACK

★ This product only includes the parts numbered above, and the missing numbers are not used in this product.

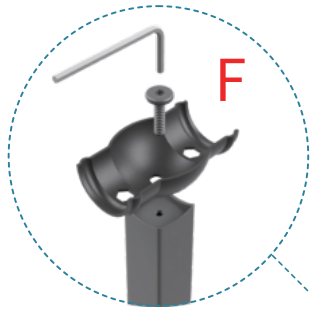



Step 1-1

Assemble Headboard:

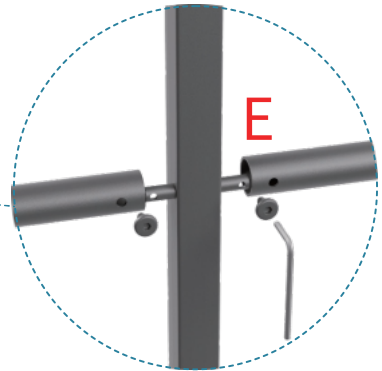
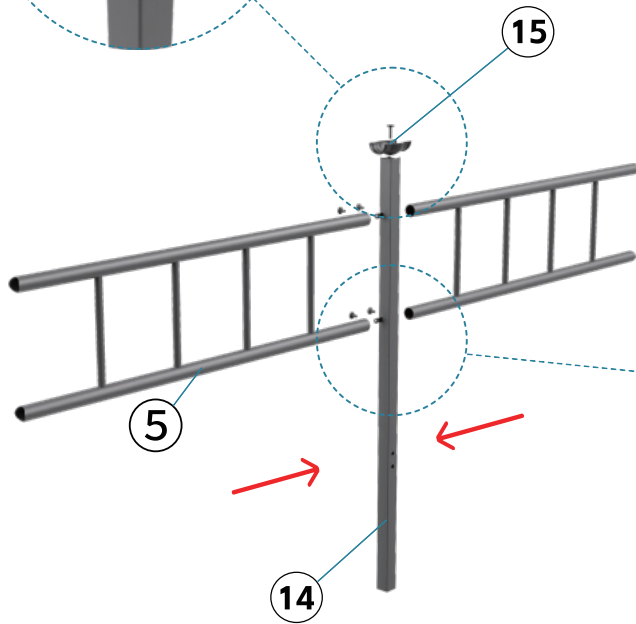
1. Tighten the headboard center post ⑭ and the connector part A ⑮ with bolts (F).
2. Connect the brackets ⑤ and the headboard center post ⑭ with bolts (E).



	M6*10	E x 4 PCS
	M6*26	F x 1 PCS

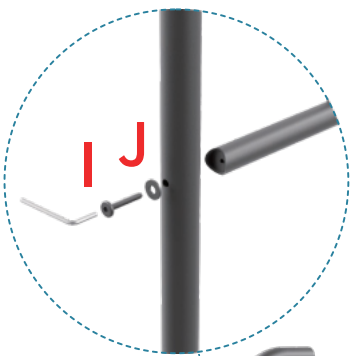



Step 1-2

Assemble Headboard:

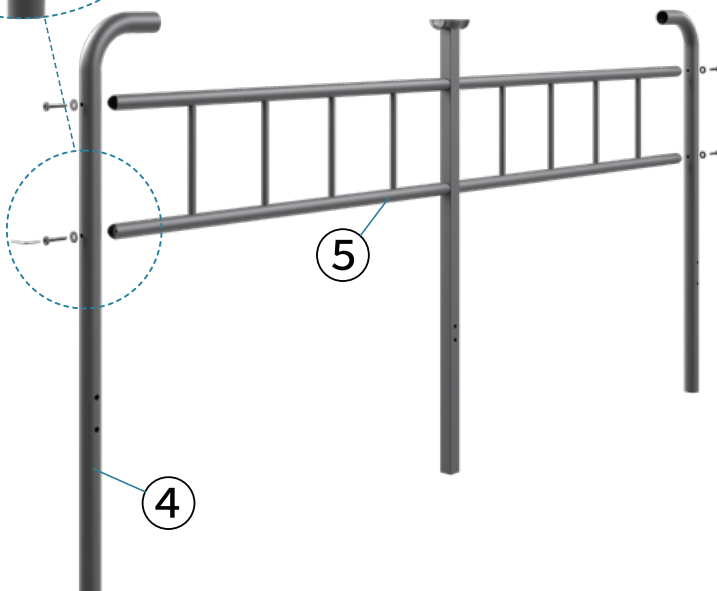
1. Connect the headboard posts ④ and the brackets ⑤ with bolts (I) and washers (J).



	Washer (M6)	J x 4 PCS
	M6*48	I x 4 PCS

Step 3

Assemble the Side Brackets :

1. Unfold the side brackets ①;
2. Connect the side brackets ① and the bed posts ④&⑪ with bolts (B) and washers (D) .

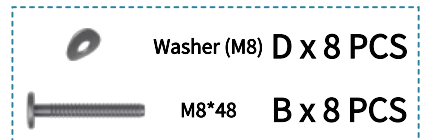
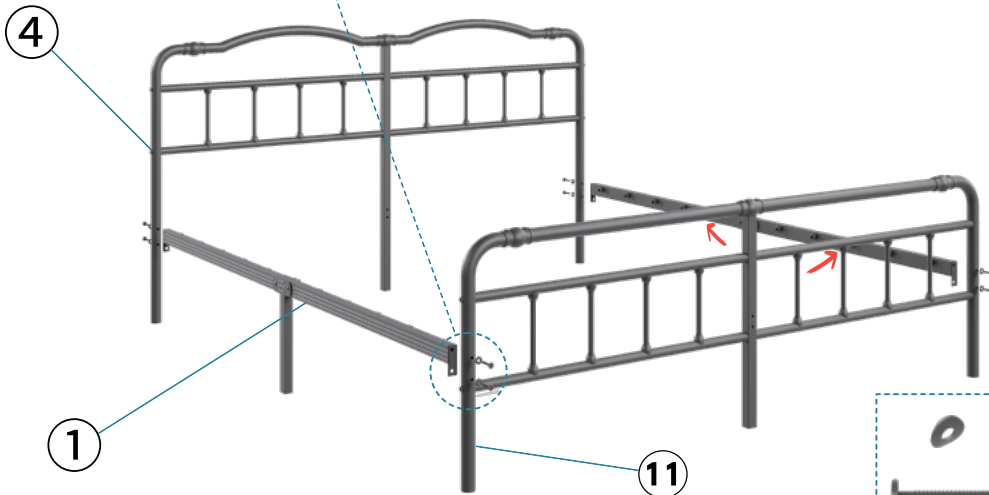
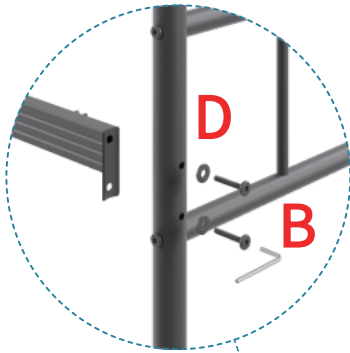

Step 4

Assemble the Center Support Rail

1. Unfold the center support rail ⑥ and assemble it with bolts (A) as shown in the figure.

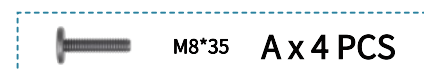
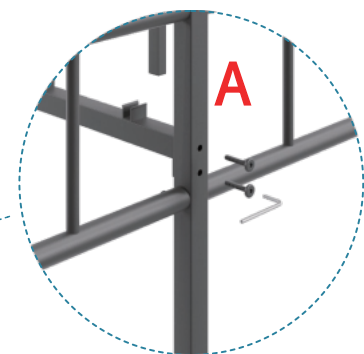
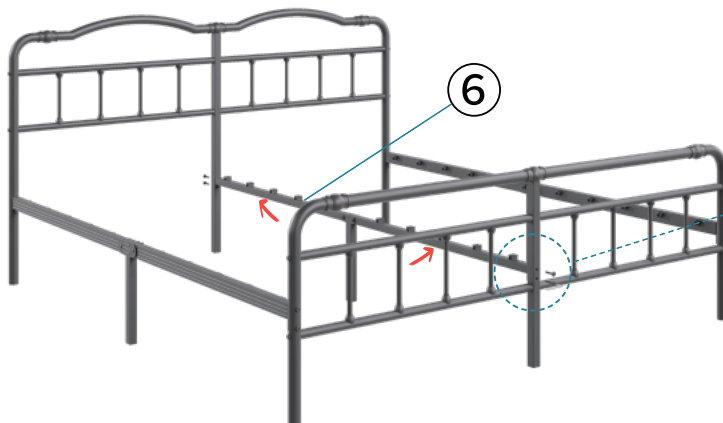



Step 5

Assemble Center Support Bar :

1. Unfold the center support bar ⑧;
2. Assemble it and the mattress gasket ⑰ with bolts (A) as shown in the figure.
3. Finally, assemble the middle position of the center support bar with bolt (C).

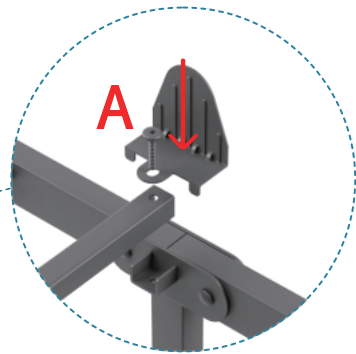
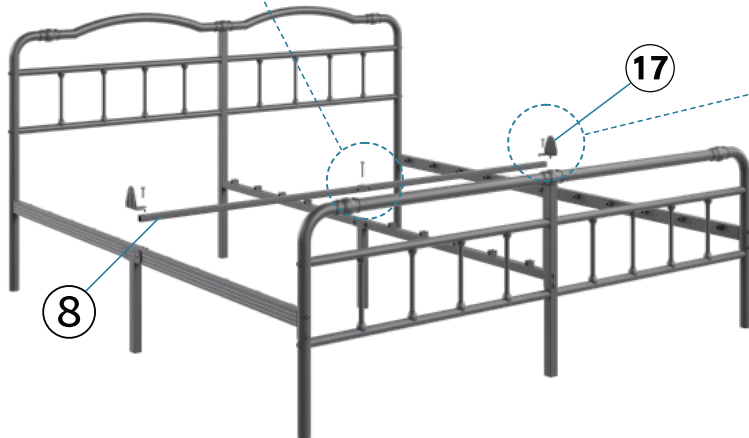
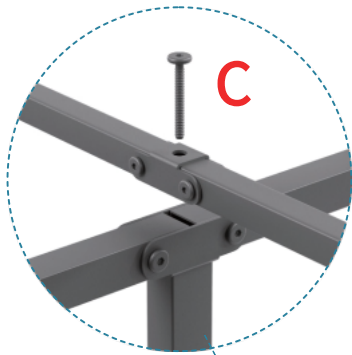
(⑰ can be installed or not. Pull the two bottom claws of the retainer outward to fully seat against the side rail, then tighten screws to avoid wobble.)



	M8*35	A x 2 PCS
	M8*56	C x 1 PCS

Step 6

Install the Slats ⑩ as shown.

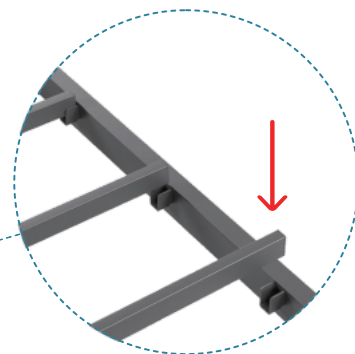
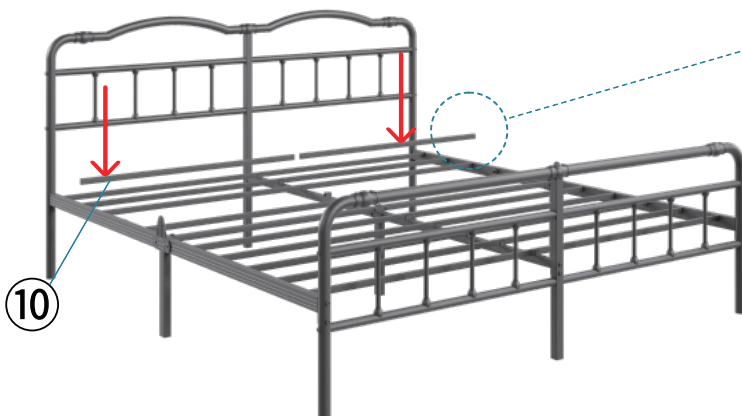

Note:

Check the tightness of all screws, retighten them, and ensure the structure is stable.

Reminder:

Regularly inspect the tightness of screws every 6 months. Retighten any loose ones promptly to maintain stability.

Cleaning & Care:

Use a dry or slightly damp soft cloth for cleaning. Avoid abrasive cleaners and corrosive substances (e.g., alcohol, bleach) to protect the product's finish. Regularly wipe off dust to extend service life.”

Please keep these instructions for future reference!

BACK