

Installation & Assembly

Contents

English ————— 01-06

German ————— 07-12

French ————— 13-18

Components

01 Backrest (×1)

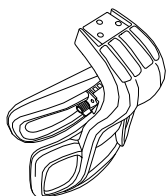

02 Seat (×1)

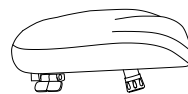

03 Casters (×5)

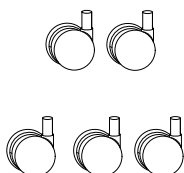

04 Armrest (×2)

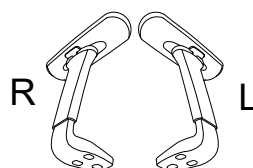

05 Cylinder (×1)



06 Base (×1)

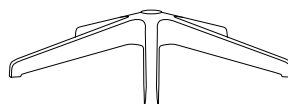

07 Headrest (×1)

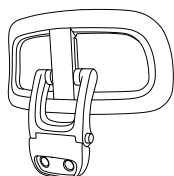

A x2+1 M6X30MM

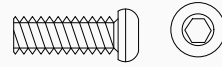

B x4+1 M6X35MM

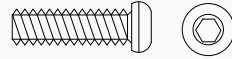

C x3+1 M8X45MM

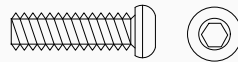

D x3+1 M8



E x3+1 M8X17X1.5MM



F x2+1 M6X25MM

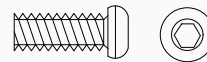

G x1



H x1



Installation

The installation steps are as follows:

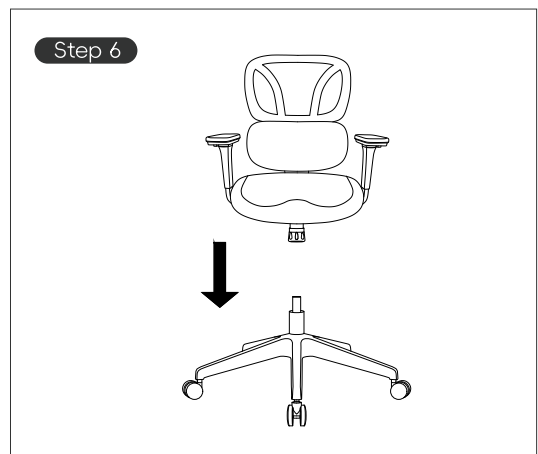
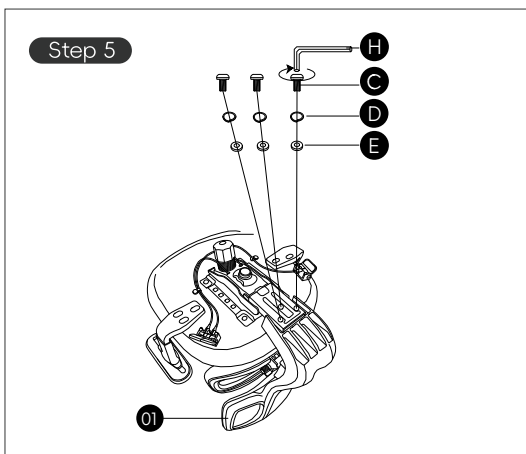
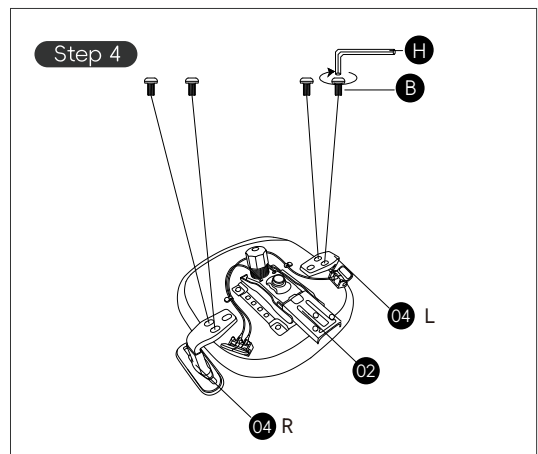
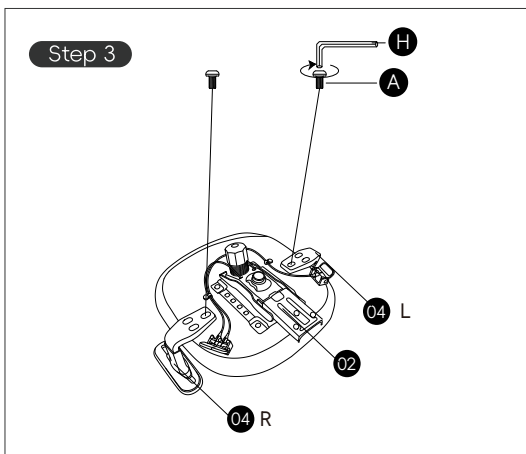
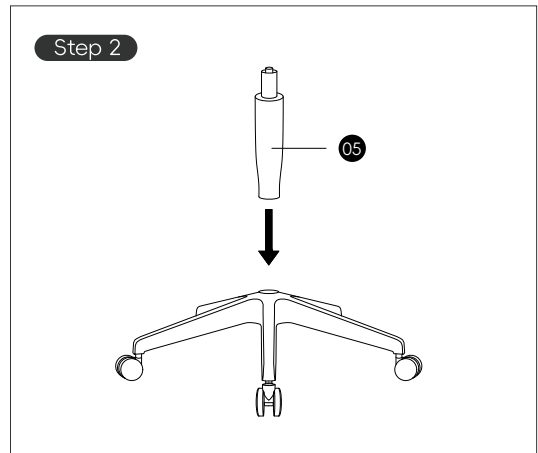
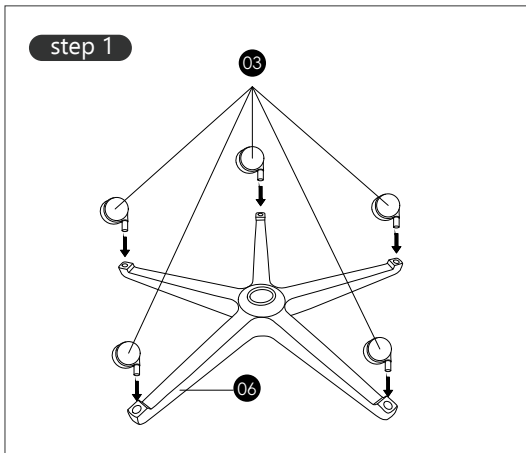

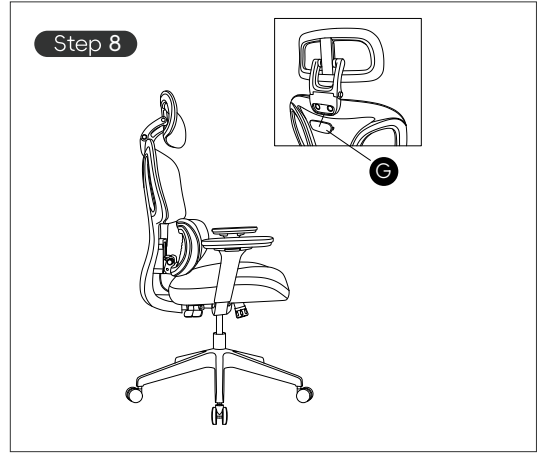
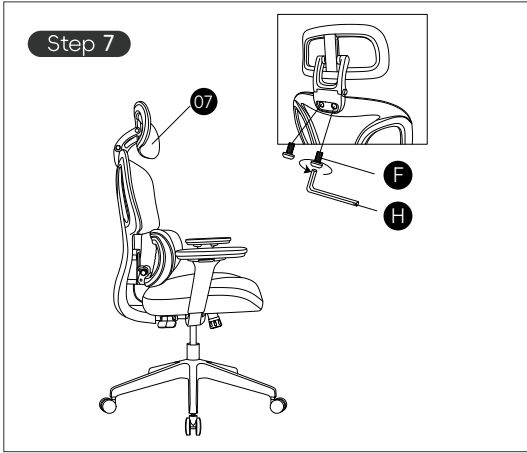

User Guide

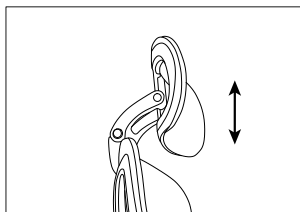

Headrest Height Adjustment.

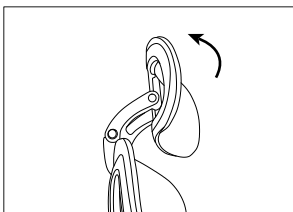

Headrest Frame Rotation Adjustment.

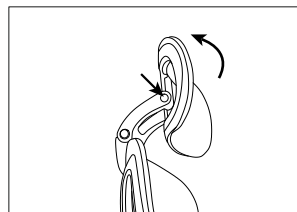

Hold the button to rotate the headrest.

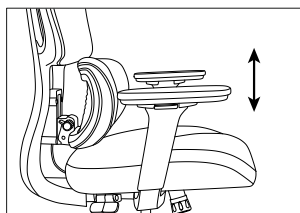

Armrest height adjustment.

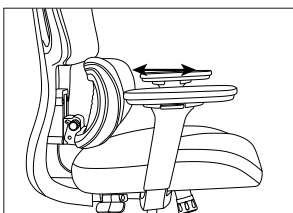

Armrest forward and backward adjustment.

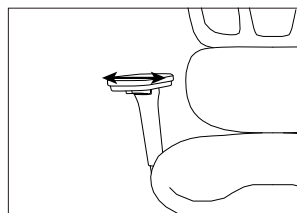

Armrest left and right adjustment.

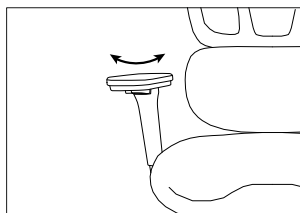

Armrest rotation adjustment.

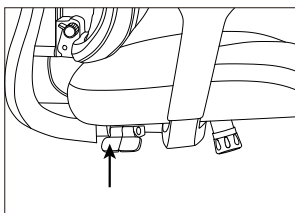

Push the left handle down to recline; lift it to lock.

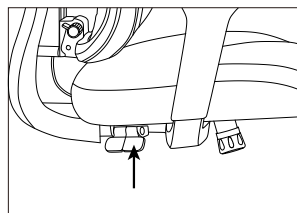

Lift the right handle to adjust the height of the seat.

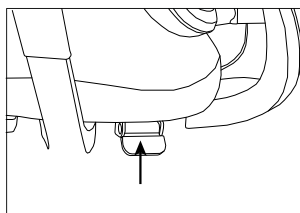

Lift the handle to slide the seat forward or backward.

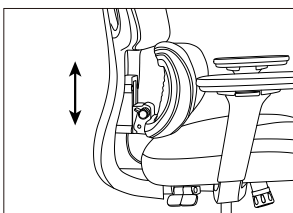

Lumbar support adjustable vertically.

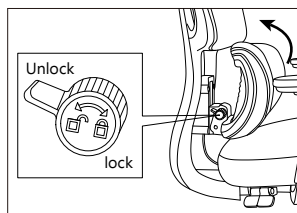

Lean back and turn the knob to adjust the lumbar support.

Caution

- Use this product only for seating one person at a time.
- Some screws may be preassembled. If preassembled, ignore assembly instructions.
- Handle cylinders and mechanical components with care. They may contain grease that could stain chair surfaces or clothing if contacted.
- Do not use this chair as a step stool/ladder, or on uneven floor surfaces.
- Do not sit on any part of the chair except the seat.
- Do not use chair unless all bolts, screws, and knobs are tightened.
- Every six months, ensure all bolts, screws, and knobs are fully tightened to maintain stability.
- If any components are missing, damaged, deformed, or worn, discontinue use and repair only with manufacturer-authorized parts.
- Failure to follow these warnings could result in serious injury.

Komponenten

01 Die Stuhllehne (×1)

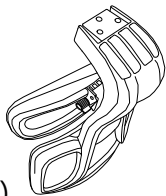

02 Der Sitz (×1)

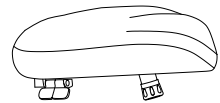

03 Die Rollen (×5)

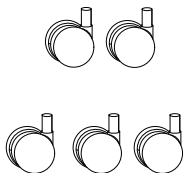

04 Die Armlehnen (×2)

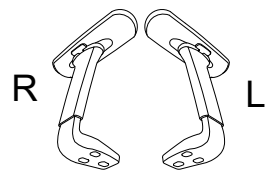

05 Der Zylinder (×1)



06 Die Basis (×1)

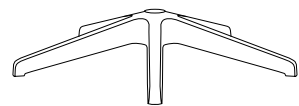

07 Die Kopflehne (×1)

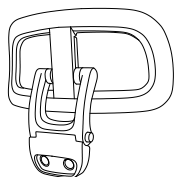

A x2+1 M6X30MM

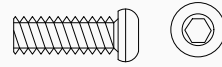

B x4+1 M6X35MM

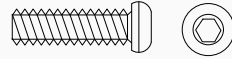

C x3+1 M8X45MM

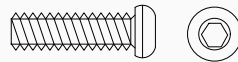

D x3+1 M8



E x3+1 M8X17X1.5MM



F x2+1 M6X25MM

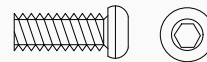

G x1



H x1



Montageanleitung

Die Montageanleitung läuft wie folgt ab:

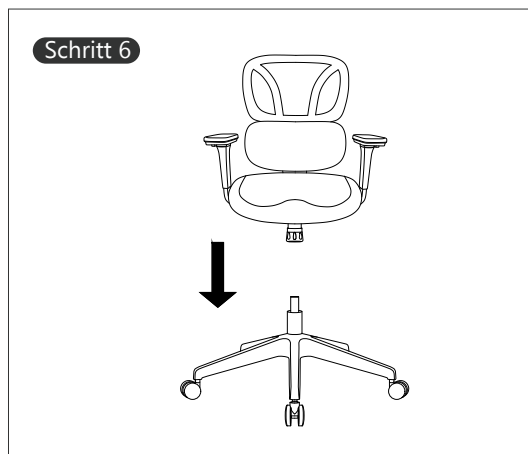
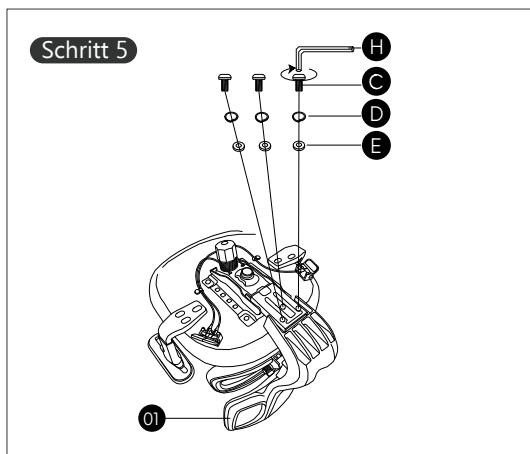
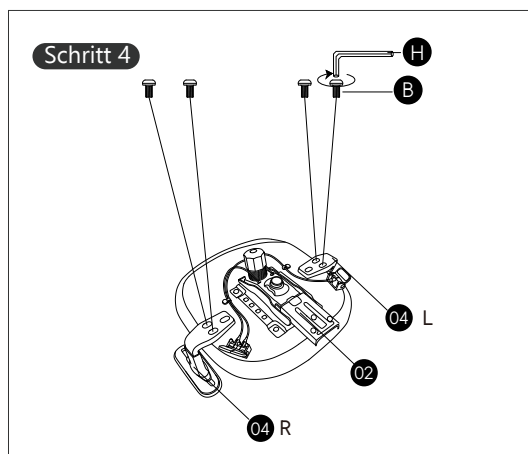
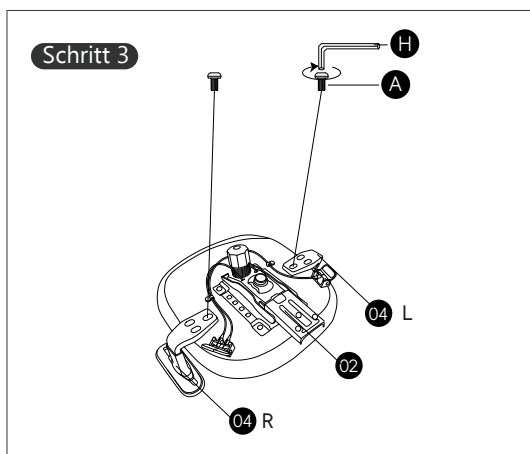
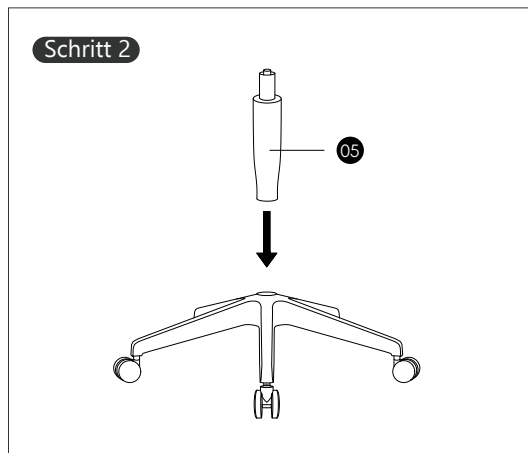
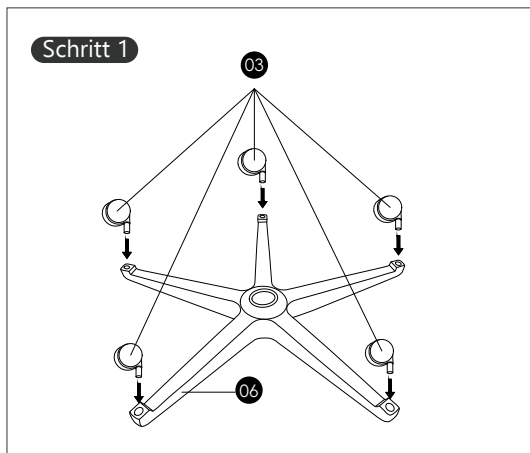

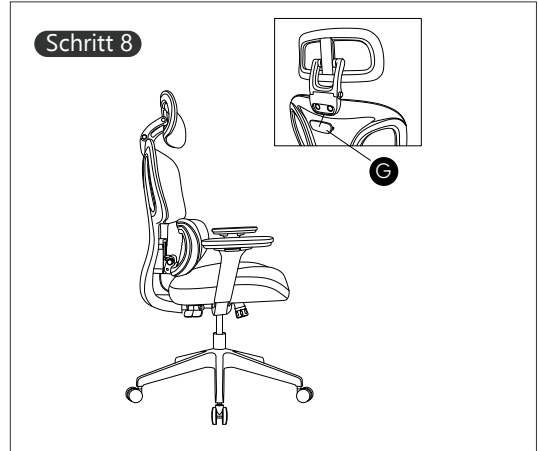
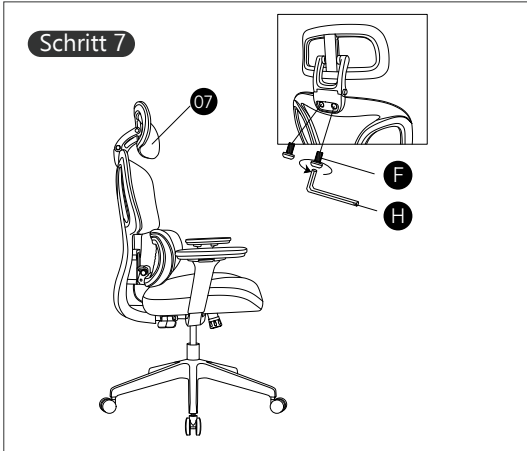

Benutzerhandbuch

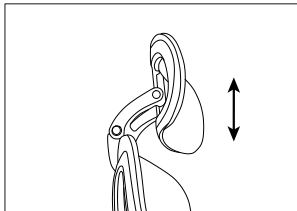

Höhenverstellung der Kopfstütze.

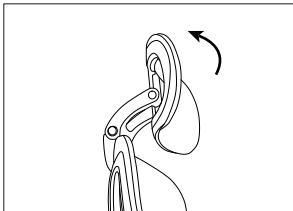

Drehverstellung des Kopfstützenrahmens.

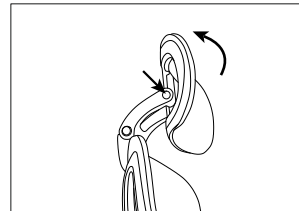

Taste gedrückt halten, um die Kopfstütze zu drehen.

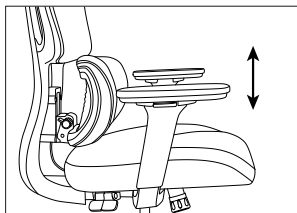

Höhenverstellung der Armlehne.

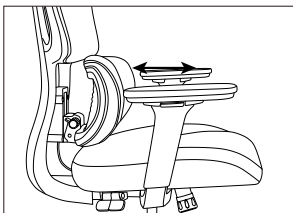

Armlehnenverstellung vorwärts und rückwärts.

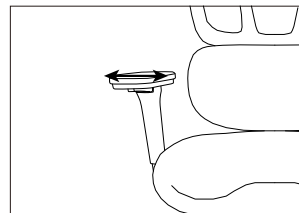

Armlehnenverstellung nach links und rechts.

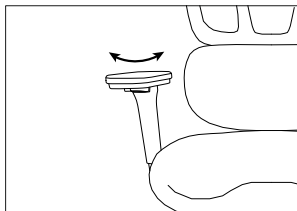

Drehverstellung der Armlehne.

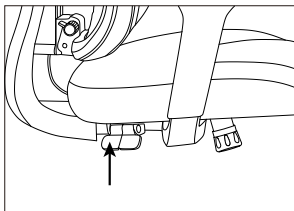

Hebel drücken zum Neigen, heben zum Verriegeln.

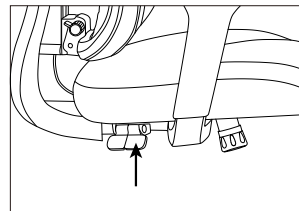

Rechten Hebel anheben, um die Sitzhöhe einzustellen.

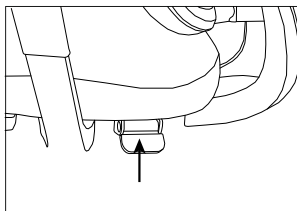

Hebel anheben, um den Sitz vor- oder zurückzuschieben.

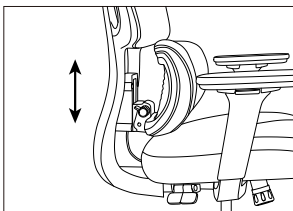

Lendenstütze vertikal verstellbar.

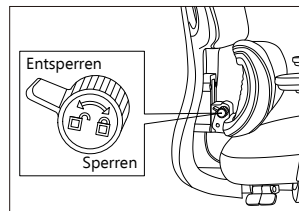

Zurücklehnen und Knopf zur Lendenstütze drehen.

Achtung

- Verwenden Sie dieses Produkt nur für die Benutzung durch jeweils eine Person.
- Einige Schrauben können vormontiert sein. Wenn sie vormontiert sind, ignorieren Sie die Montageanleitung.
- Sie können Schmierfett enthalten, die bei Kontakt mit der Stuhloberfläche oder der Kleidung Flecken verursachen kann.
- Verwenden Sie den Stuhl nicht als Tritthocker/Leiter oder auf unebenen Böden.
- Setzen Sie sich auf keinen Teil des Stuhls außer auf den Sitz.
- Benutzen Sie den Stuhl nicht, wenn nicht alle Bolzen, Schrauben und Knöpfe fest angezogen sind.
- Stellen Sie alle sechs Monate sicher, dass alle Bolzen, Schrauben und Knöpfe fest angezogen sind, um die Stabilität zu gewährleisten.
- Wenn Teile fehlen, beschädigt, verformt oder abgenutzt sind, verwenden Sie den Stuhl nicht mehr und reparieren Sie ihn nur mit vom Hersteller zugelassenen Teilen.
- Die Nichtbeachtung dieser Warnhinweise kann zu schweren Verletzungen führen.

Composants

01 Dossier (x1)

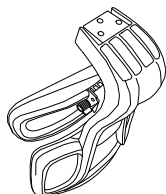

02 Assise (x1)

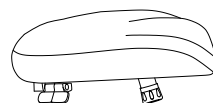

03 Roulettes (x5)

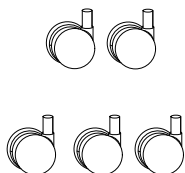

04 Accoudoirs (x2)

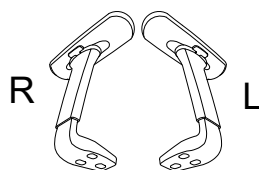

05 Vérin (x1)



06 Base (x1)

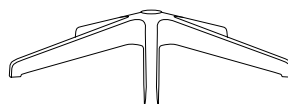

07 Appuie-tête (x1)

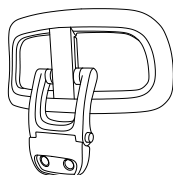

A x2+1 M6X30MM

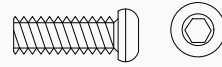

B x4+1 M6X35MM

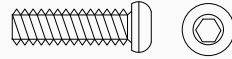

C x3+1 M8X45MM

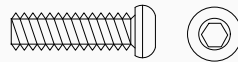

D x3+1 M8



E x3+1 M8X17X1.5MM



F x2+1 M6X25MM

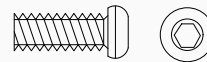

G x1



H x1



Installation

Les étapes d'installation sont les suivantes :

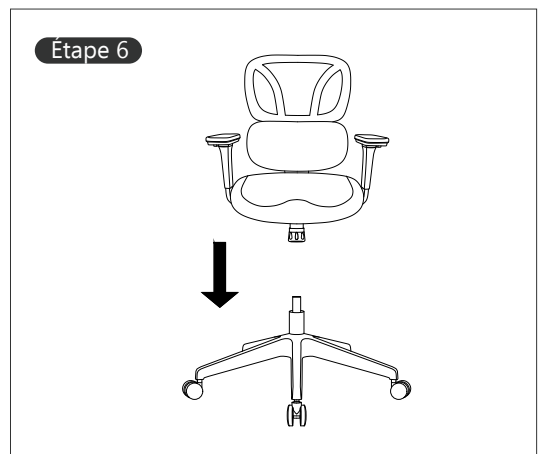
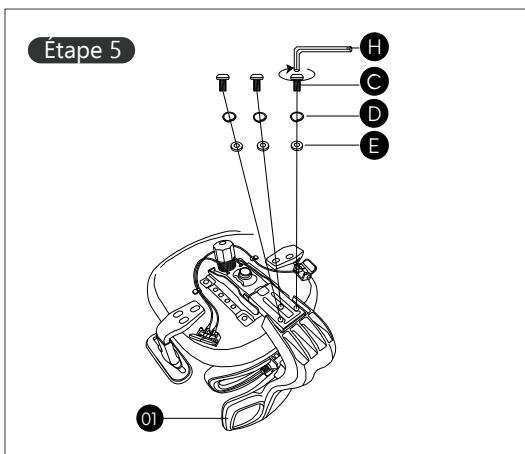
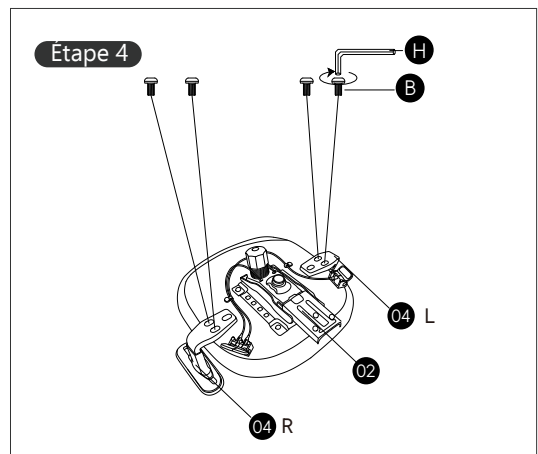
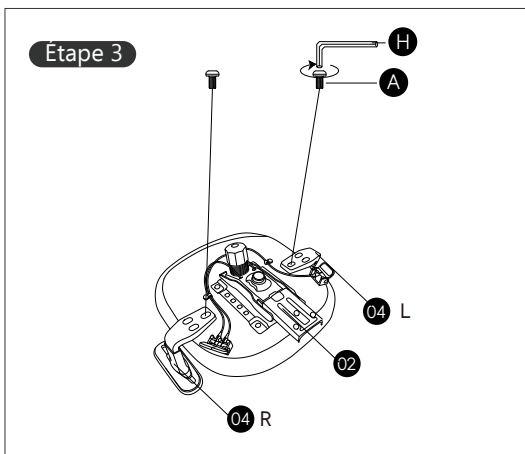
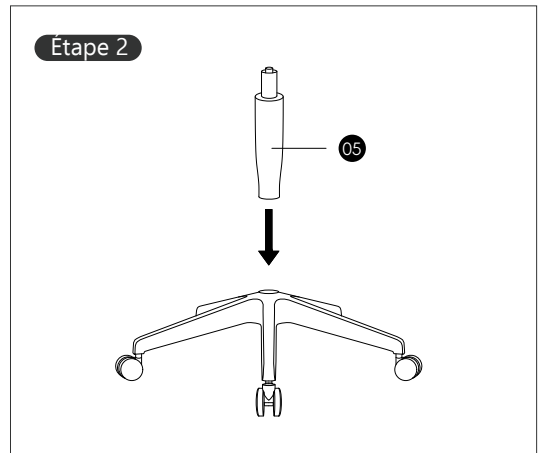
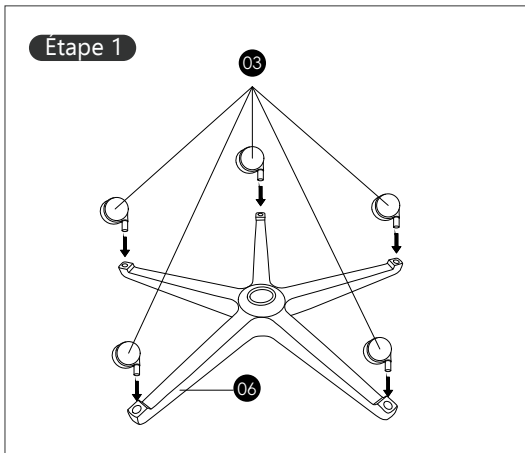

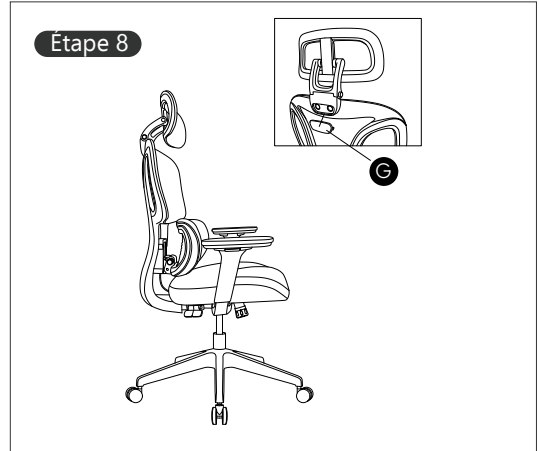
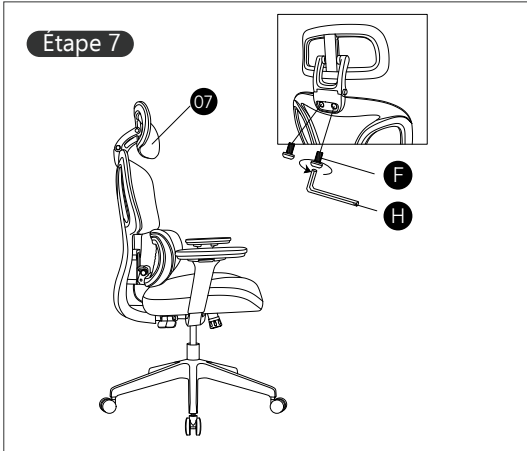

Guide d'utilisation

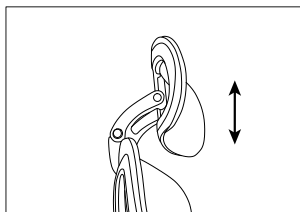

Réglage de la hauteur de l'appui-tête.

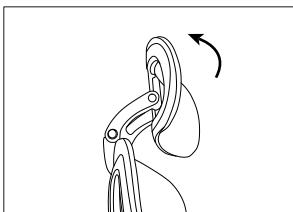

Réglage de la rotation du cadre de l'appui-tête.

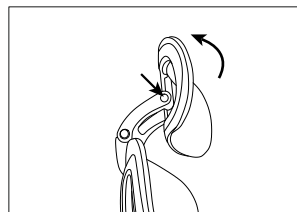

Maintenez le bouton enfoncé pour faire pivoter l'appui-tête.

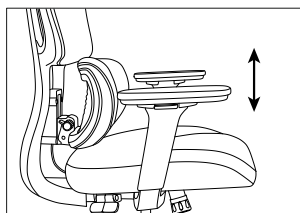

Réglage de la hauteur des accoudoirs.

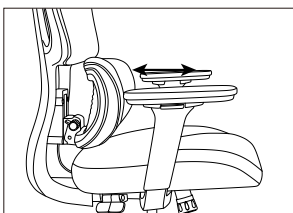

Réglage avant/arrière des accoudoirs.

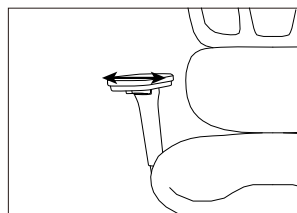

Réglage latéral (gauche/droite) des accoudoirs.

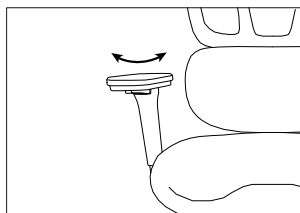

Réglage de la rotation des accoudoirs.

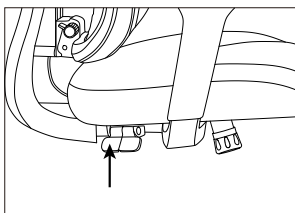

Poignée gauche : basculez pour incliner, relevez pour verrouiller.

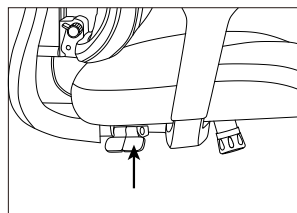

Relevez la poignée droite pour régler la hauteur du siège.

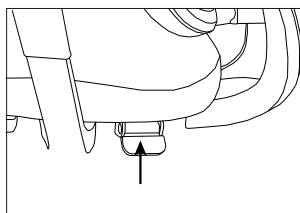

Relevez la poignée pour avancer ou reculer le siège.

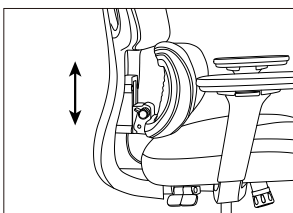

Soutien lombaire réglable verticalement.

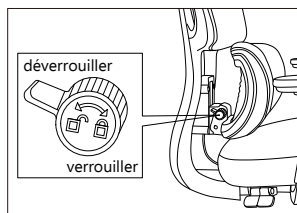

Inclinez-vous et tournez le bouton pour régler le soutien lombaire.

Attention

- Ce produit ne peut être utilisé que pour asseoir une seule personne à la fois.
- Certains vis peuvent être préassemblés. En cas de préassemblage, ignorez les instructions d'assemblage.
- Manipulez avec soin les cylindres et les composants mécaniques. Ils peuvent contenir de la graisse qui pourrait tacher les surfaces de la chaise ou le vêtement en cas de contact.
- Ne pas utiliser cette chaise en tant que tabouret/échelle, ou sur des surfaces de sol inégales.
- Ne pas s'asseoir sur toute partie de la chaise autre que le siège.
- Ne pas utiliser la chaise si tous les boulons, vis et boutons ne sont pas serrés.
- Tous les six mois, assurez-vous que tous les boulons, vis et boutons sont entièrement serrés pour maintenir la stabilité.
- Si des composants manquent, sont endommagés, déformés ou usés, arrêtez l'utilisation et ne les réparez que avec des pièces autorisées par le fabricant.
- Le non-respect de ces avertissements pourrait entraîner de graves blessures.