

page1

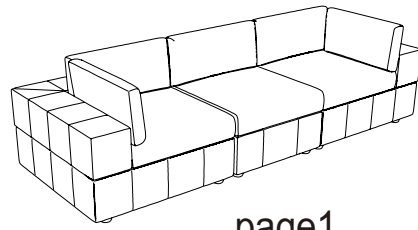

page1

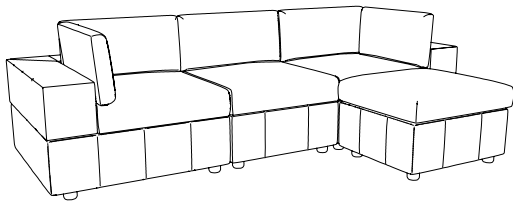

page1

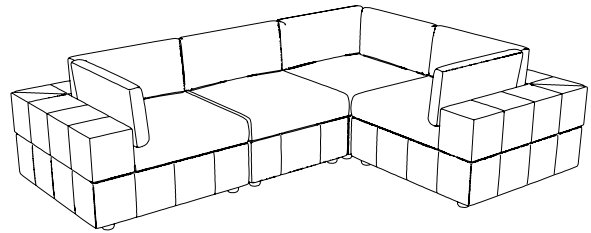

page2

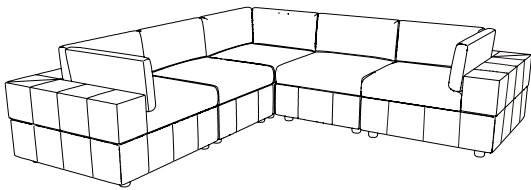

page2

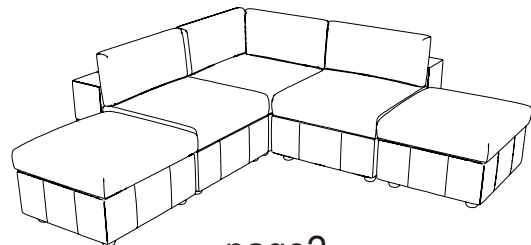

page2

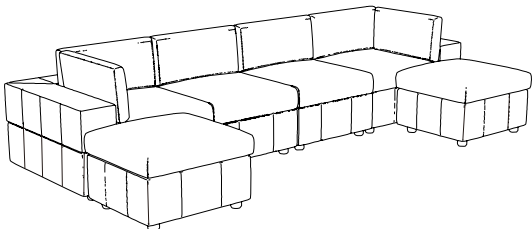

page3

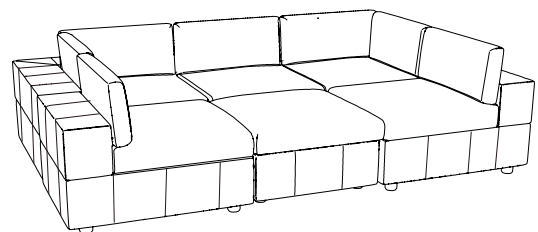

page3

A

**Welcome to buy this series of products.**

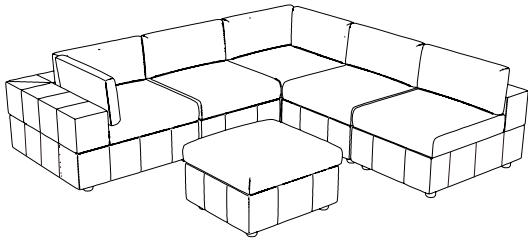

page3

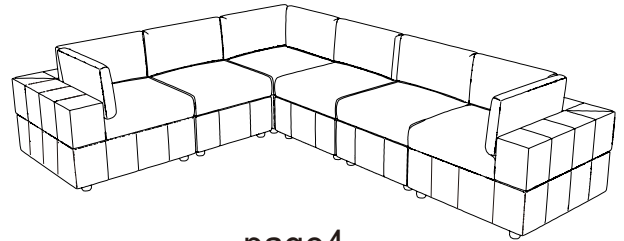

page4

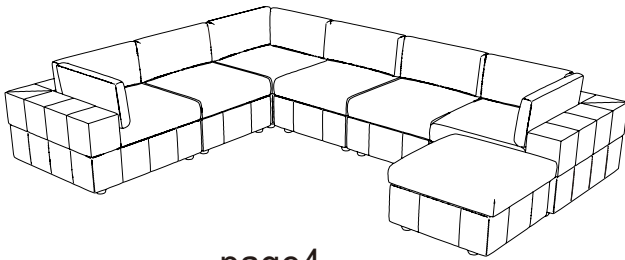

page4

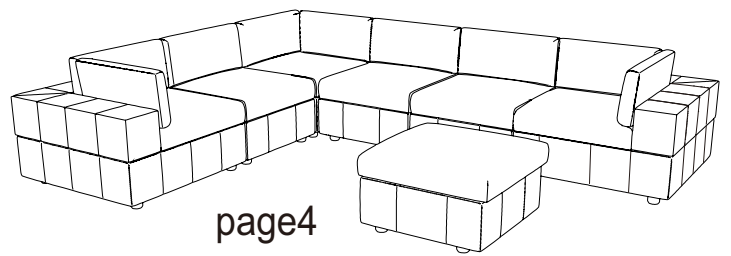

page4

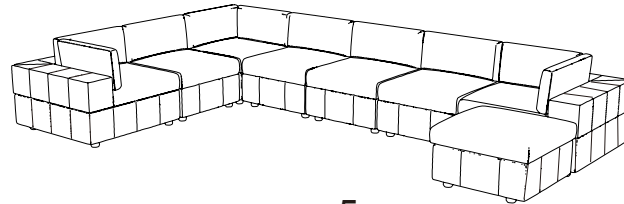

page5

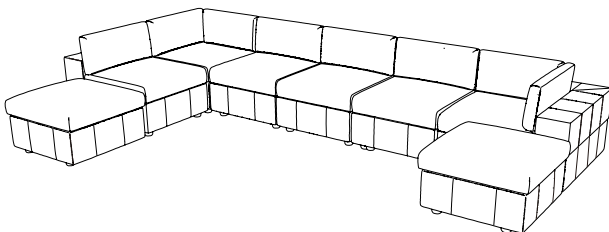

page5

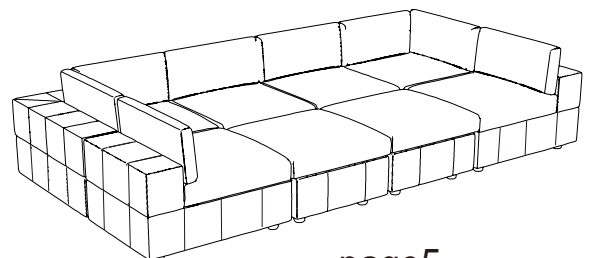

page5

**B**

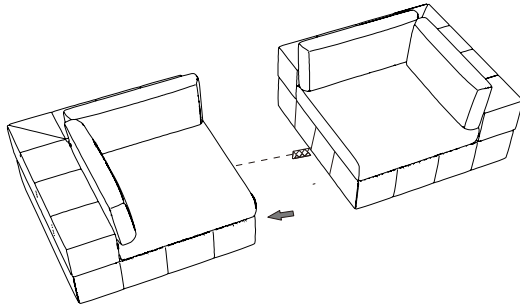
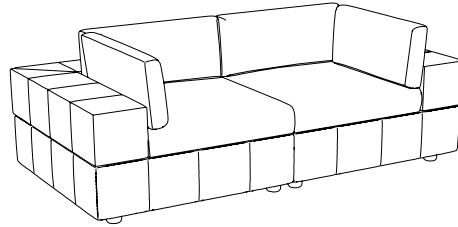

**Welcome to buy this series of products.**

PARTS	Quantity
 <b>C</b>	<b>2</b>

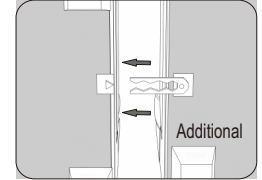

Custom Modulas Sectional  
Connect different pieces into  
the desired configuration



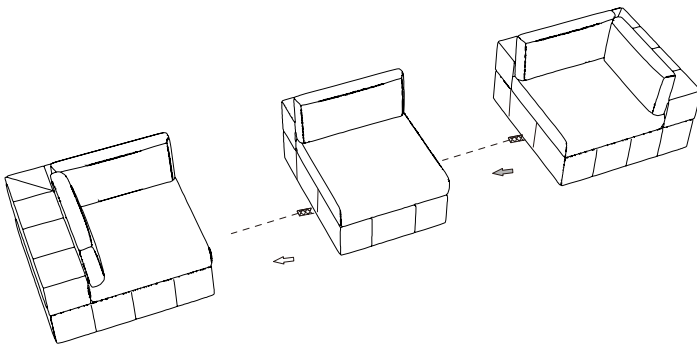
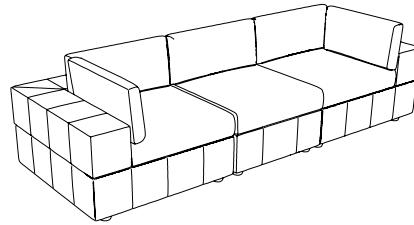

PARTS	Quantity
 <b>A</b>	<b>1</b>
 <b>C</b>	<b>2</b>

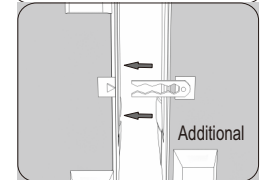

Custom Modulas Sectional  
Connect different pieces into  
the desired configuration



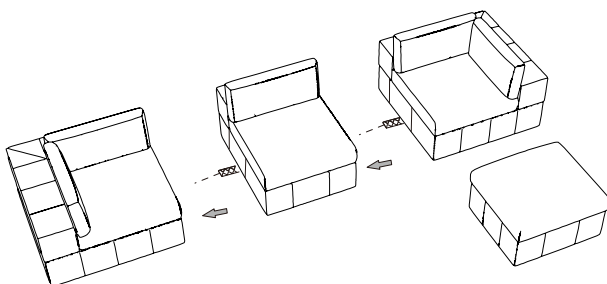
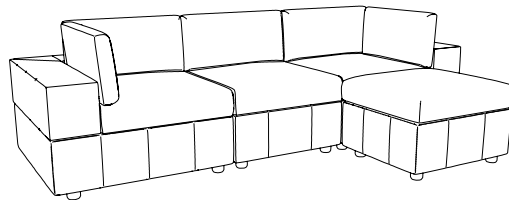

PARTS	Quantity
 <b>A</b>	<b>1</b>
 <b>C</b>	<b>2</b>
 <b>O</b>	<b>1</b>

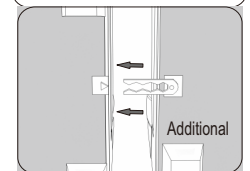

Custom Modulas Sectional  
Connect different pieces into  
the desired configuration



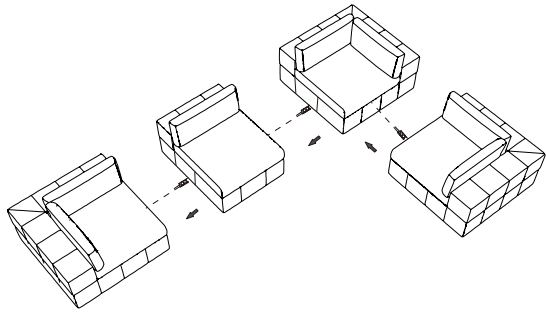
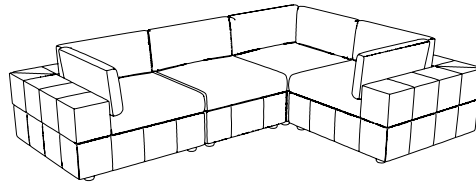

PARTS		Quantity
	<b>A</b>	<b>1</b>
	<b>C</b>	<b>3</b>

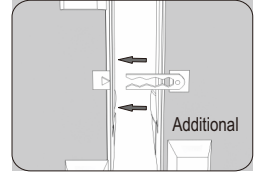

Custom Modulas Sectional  
Connect different pieces into  
the desired configuration



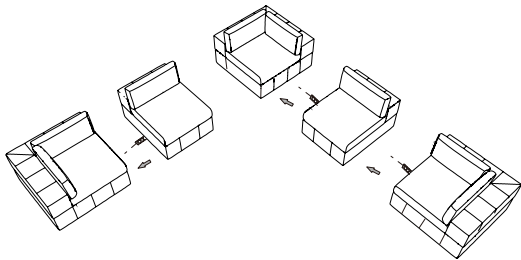
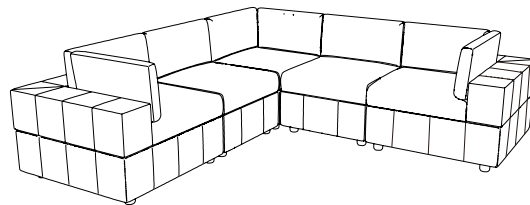

PARTS		Quantity
	<b>A</b>	<b>2</b>
	<b>C</b>	<b>3</b>

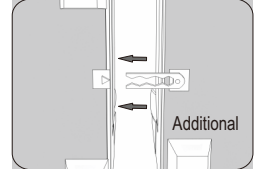

Custom Modulas Sectional  
Connect different pieces into  
the desired configuration



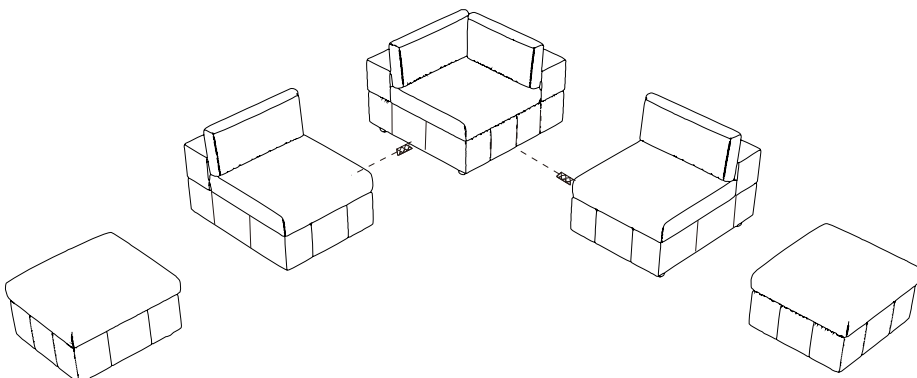
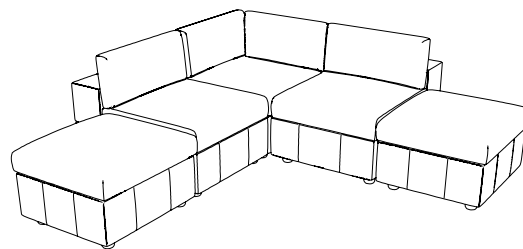

PARTS		Quantity
	<b>A</b>	<b>1</b>
	<b>C</b>	<b>3</b>
	<b>O</b>	<b>2</b>

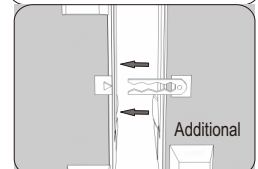

Custom Modulas Sectional  
Connect different pieces into  
the desired configuration



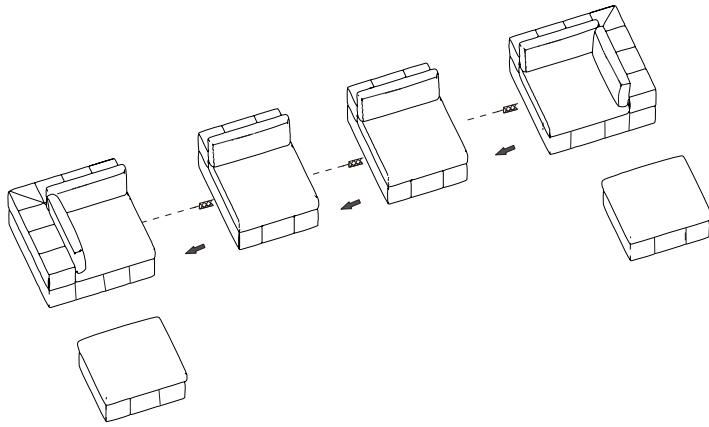
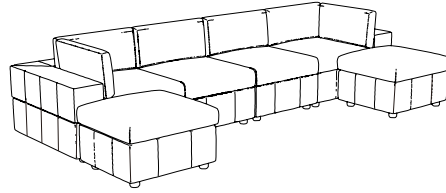

PARTS		Quantity
	A	2
	C	2
	O	2

ITEM NO.:D95800/D95801/D95802/D95803/D95804/D95805-6

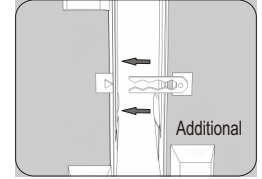

Custom Modulus Sectional  
Connect different pieces into  
the desired configuration



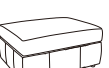

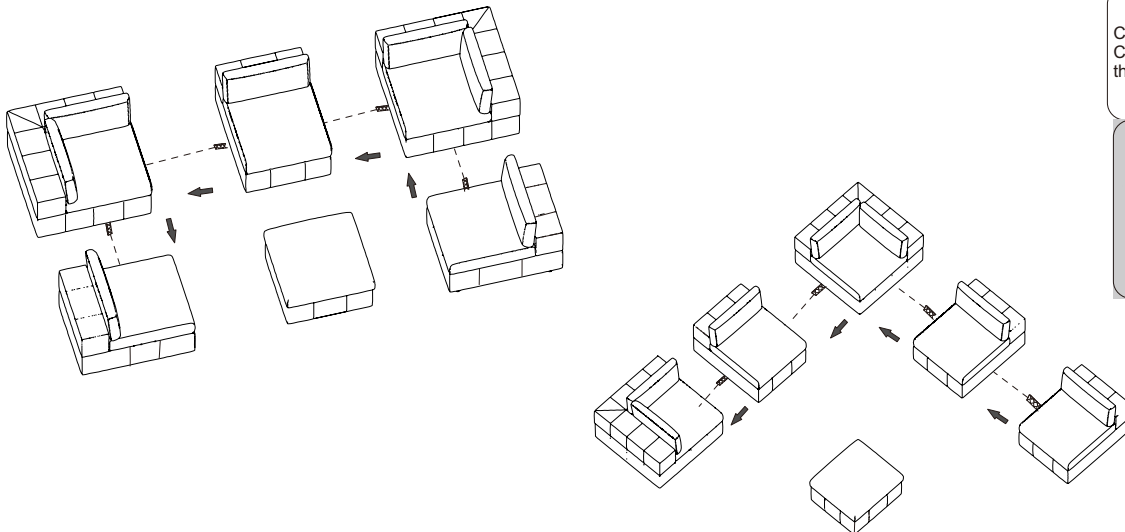
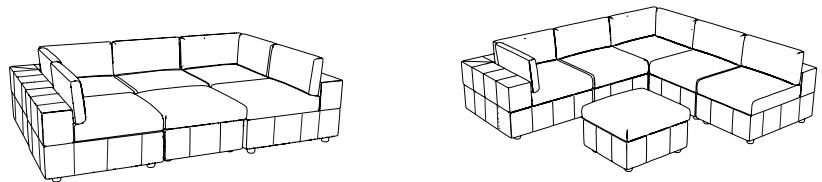
PARTS		Quantity
	A	3
	C	2
	O	1

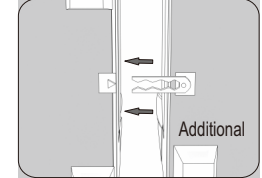

Custom Modulus Sectional  
Connect different pieces into  
the desired configuration



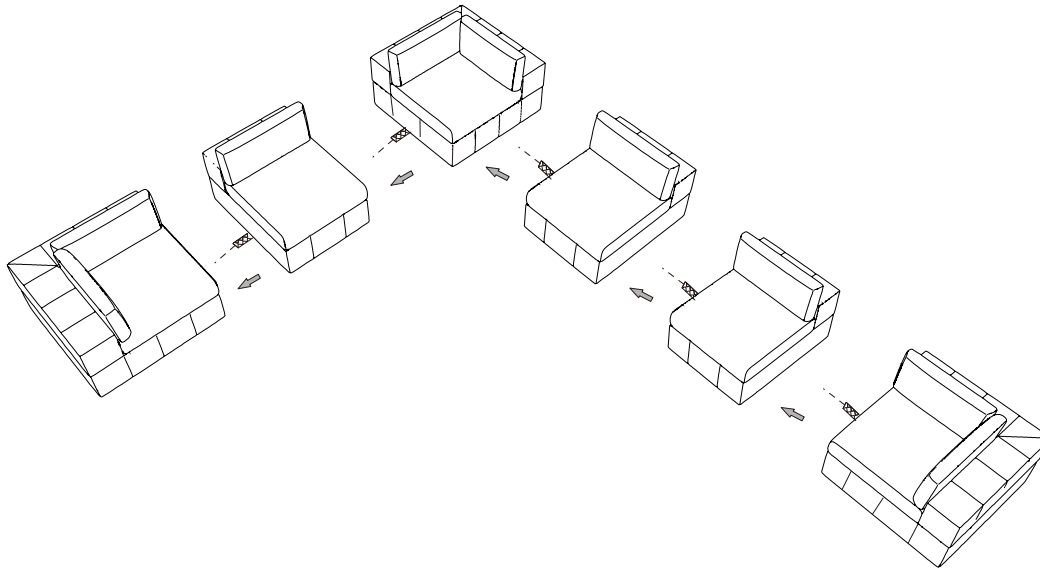
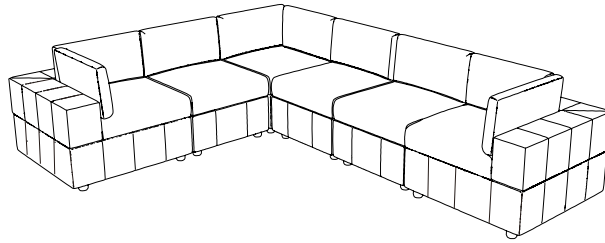

	PARTS	Quantity
	A	3
	C	3

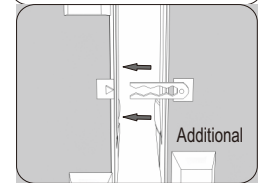

Custom Modulas Sectional  
Connect different pieces into  
the desired configuration



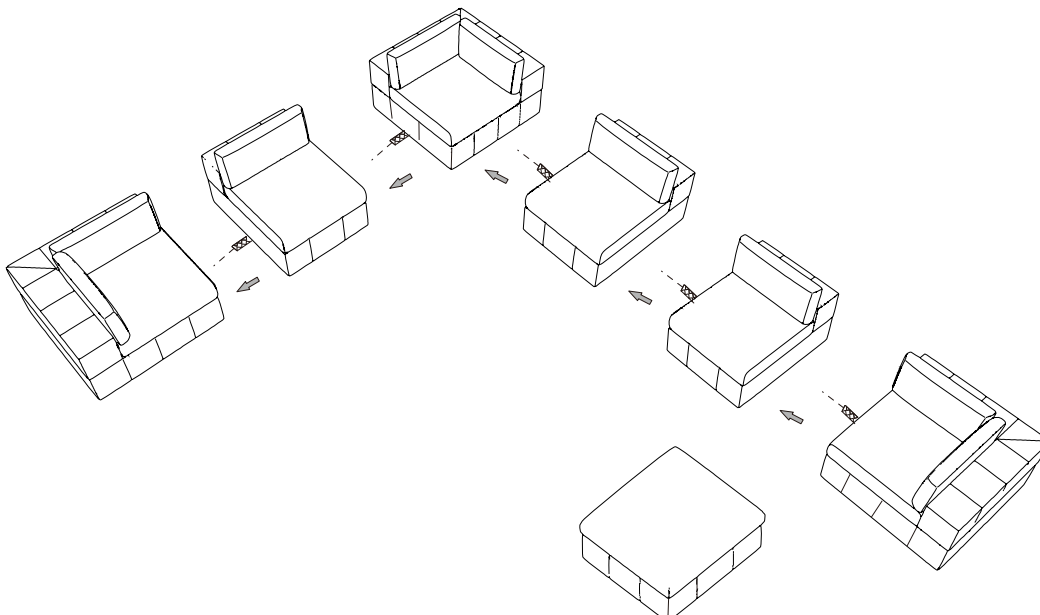
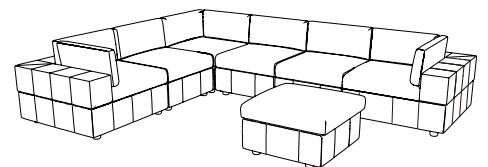
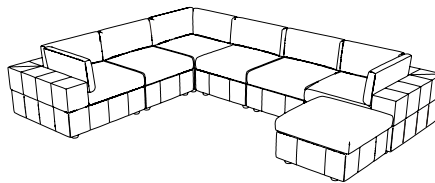

	PARTS	Quantity
	A	3
	C	3
	O	1

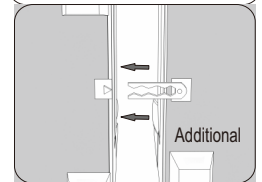

Custom Modulas Sectional  
Connect different pieces into  
the desired configuration



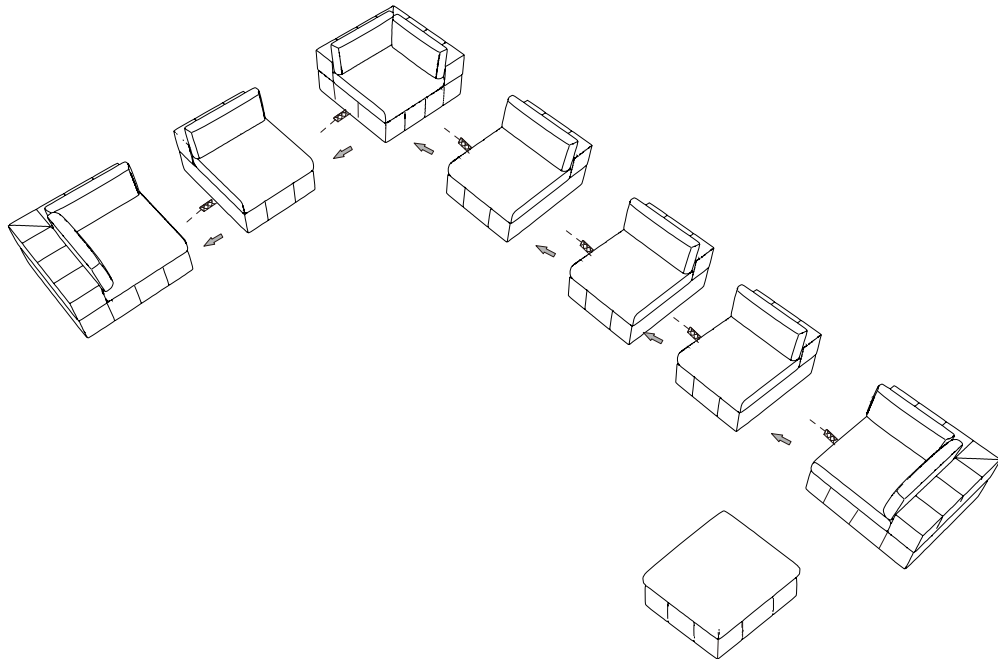
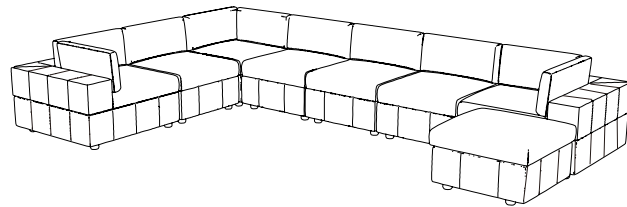

PARTS		Quantity
	A	4
	C	3
	O	1

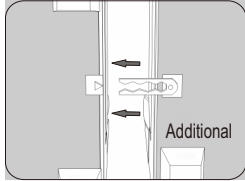

Custom Modulus Sectional  
Connect different pieces into  
the desired configuration



PARTS		Quantity
	A	4
	C	2
	O	2

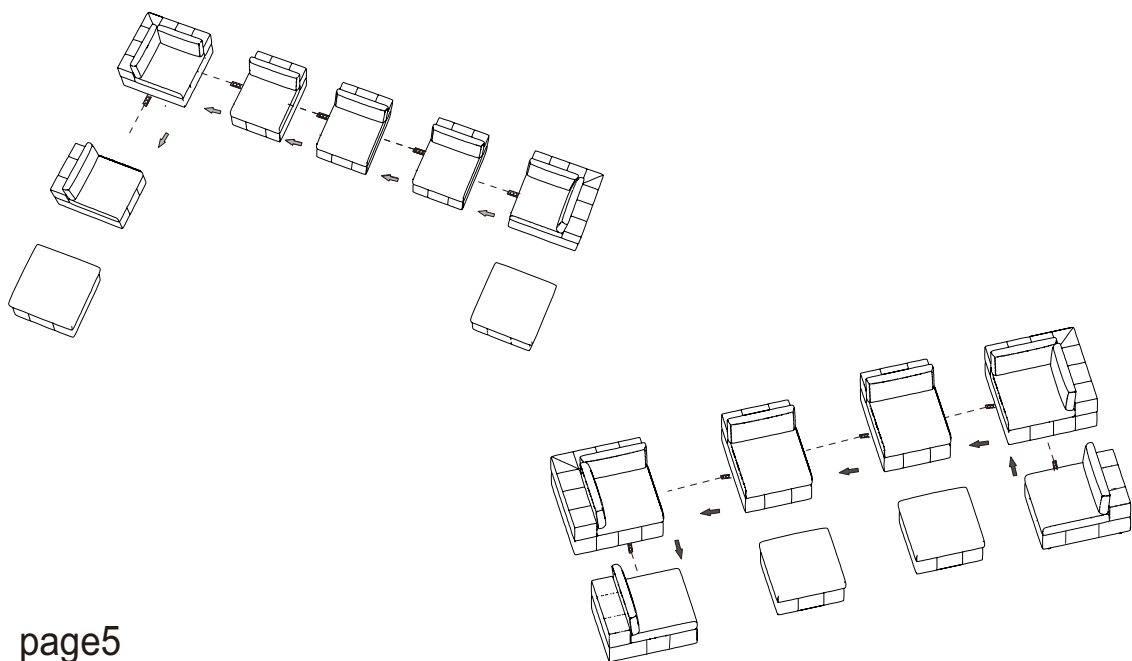
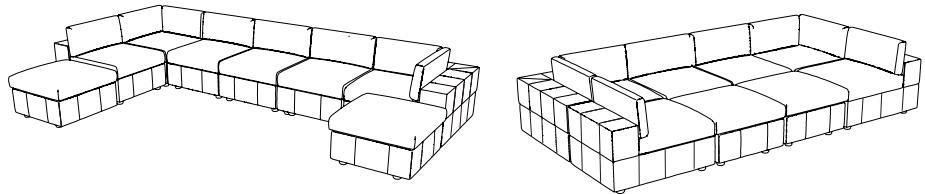

Custom Modulus Sectional  
Connect different pieces into  
the desired configuration

