



ASSEMBLY INSTRUCTION





DESCRIPTION : NIGHT STAND

Thank you for purchasing this quality product. Be sure to check all packing material carefully for small parts which may have loose inside the carton during shipment. Identify and count all parts and compare with the parts list below.

PART LIST#

NO	DRAWING	DESCRIPTION	QTY
A		Night Stand	1pc
B		Bun Foot	2pcs
C		Metal Leg	2pcs

HARDWARE LIST#

NO	NAME	PART	QTY
1	Allen Key		1pc
2	JCBC / Boulon - M6 x 20mm		4pcs
3	M6 Spring Washer		4pcs
4	M6 Flat Washer		4pcs

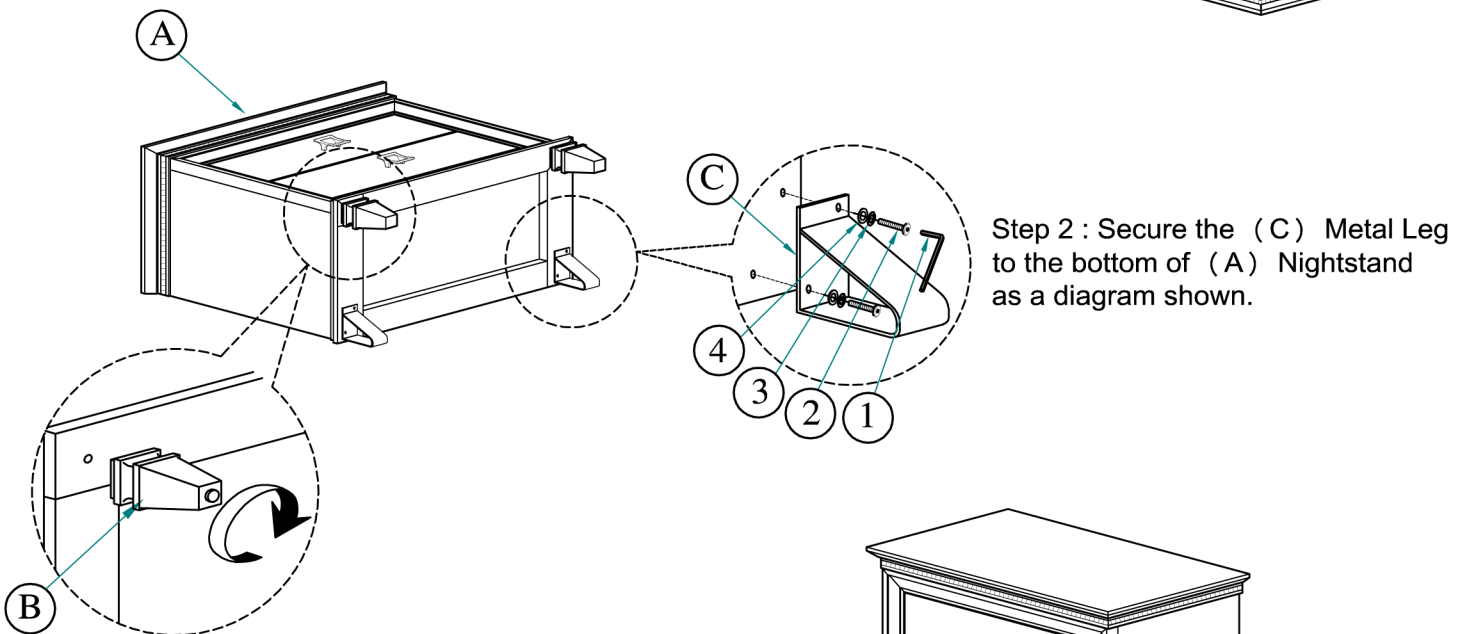
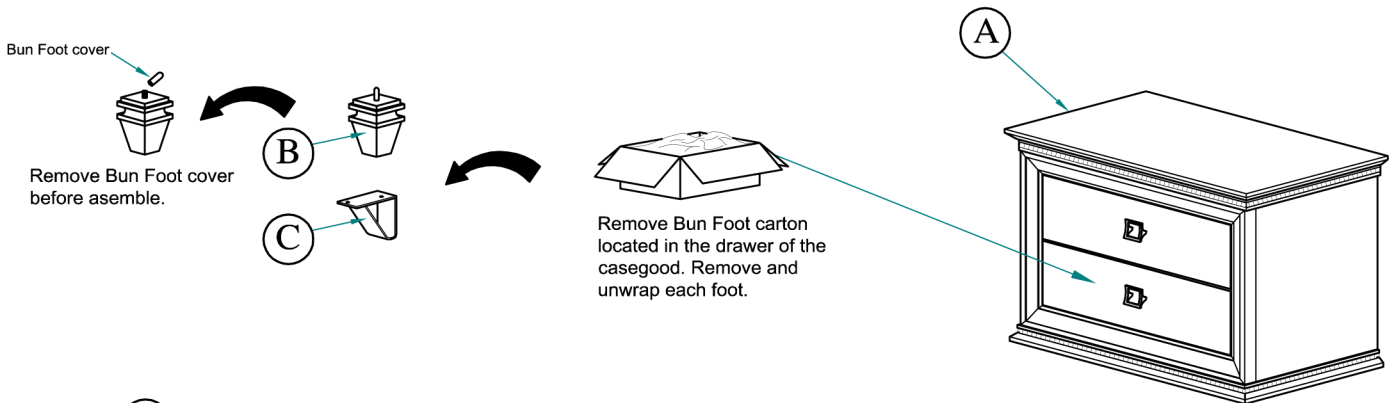



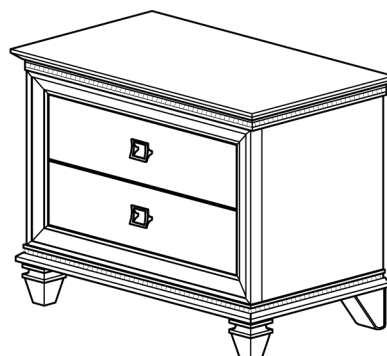

Step 1: Secure the (B) Bun Foot to the bottom of (A) Nightstand as a diagram shown.

Step 2: Secure the (C) Metal Leg to the bottom of (A) Nightstand as a diagram shown.



Assembly completed

HARDWARE LIST / LISTE DE QUINCAILLERIE

NO	NAME	PART	QTY
A	Bracket / Équerre		2pcs
B	Tie Wrap / Sangle de sécurité		1pc
C	Long Screw / Vis Longue		1pc
D	Short Screw / Vis Courte		1pc

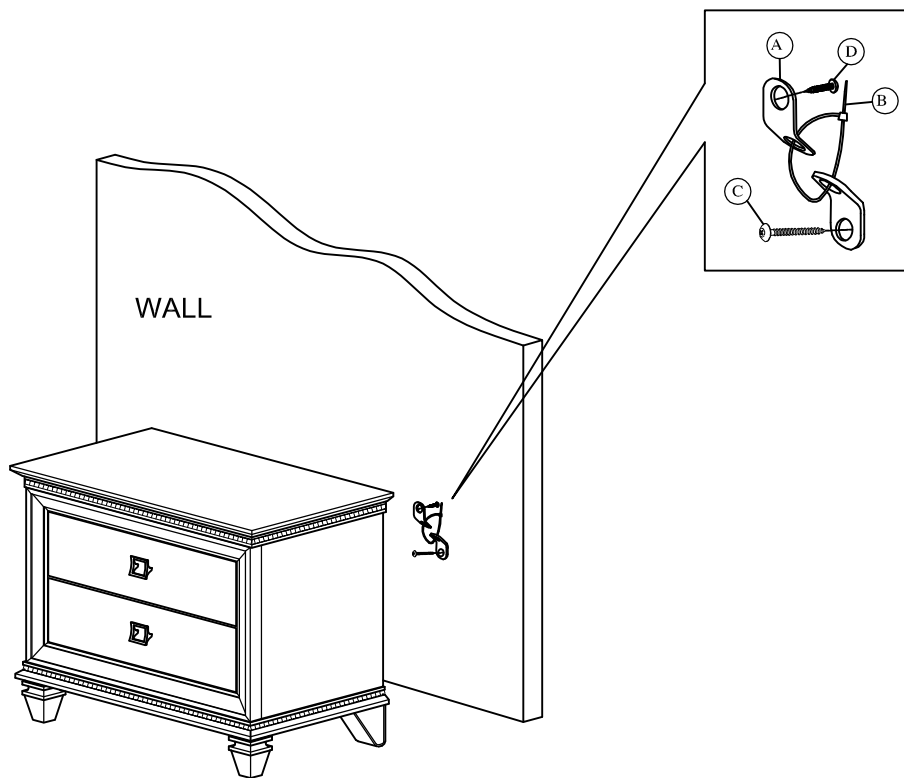

Assembly completed