

ASSEMBLY INSTRUCTION

PARTS

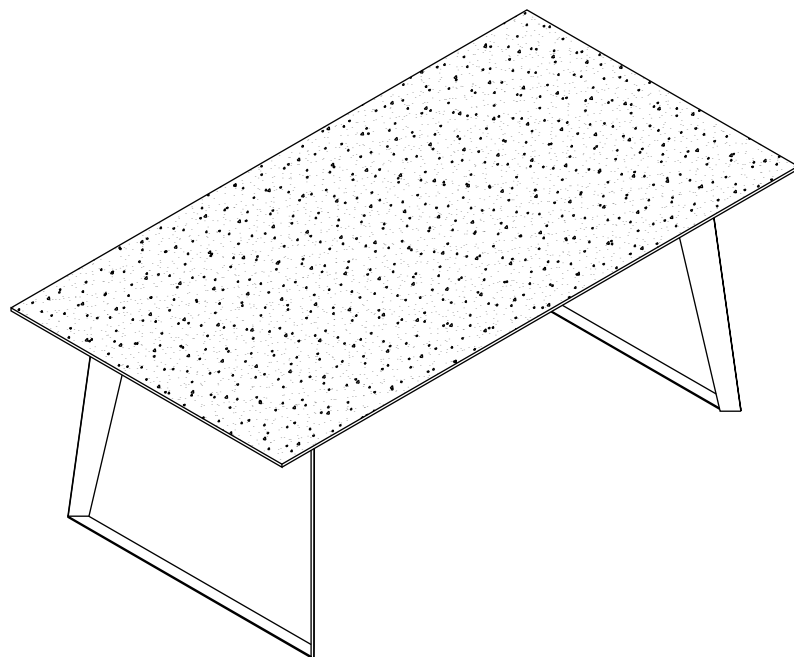

① x 1

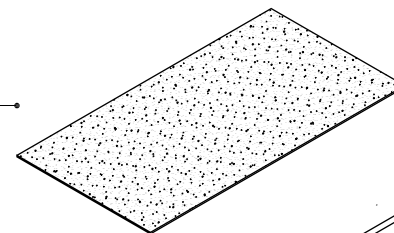

② x 1

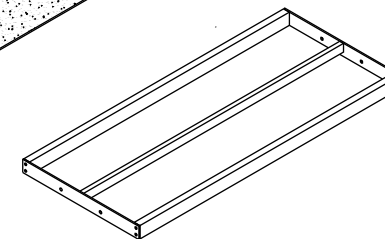

③ x 1

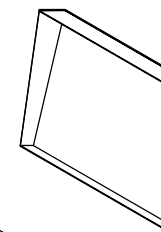

④ x 1

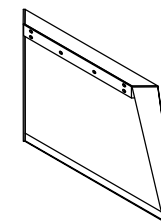

HARDWARE

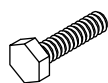

M10 X 30

Ⓐ x 8



M8 X 25

Ⓑ x 4



NUT M8

Ⓒ x 4



10 X 16

Ⓓ x 8



8 X 20

Ⓔ x 8

TOOL

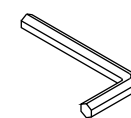

Ⓕ x 1



Ⓖ x 1



Ⓕ x 1

ASSEMBLY INSTRUCTION

STEP 1

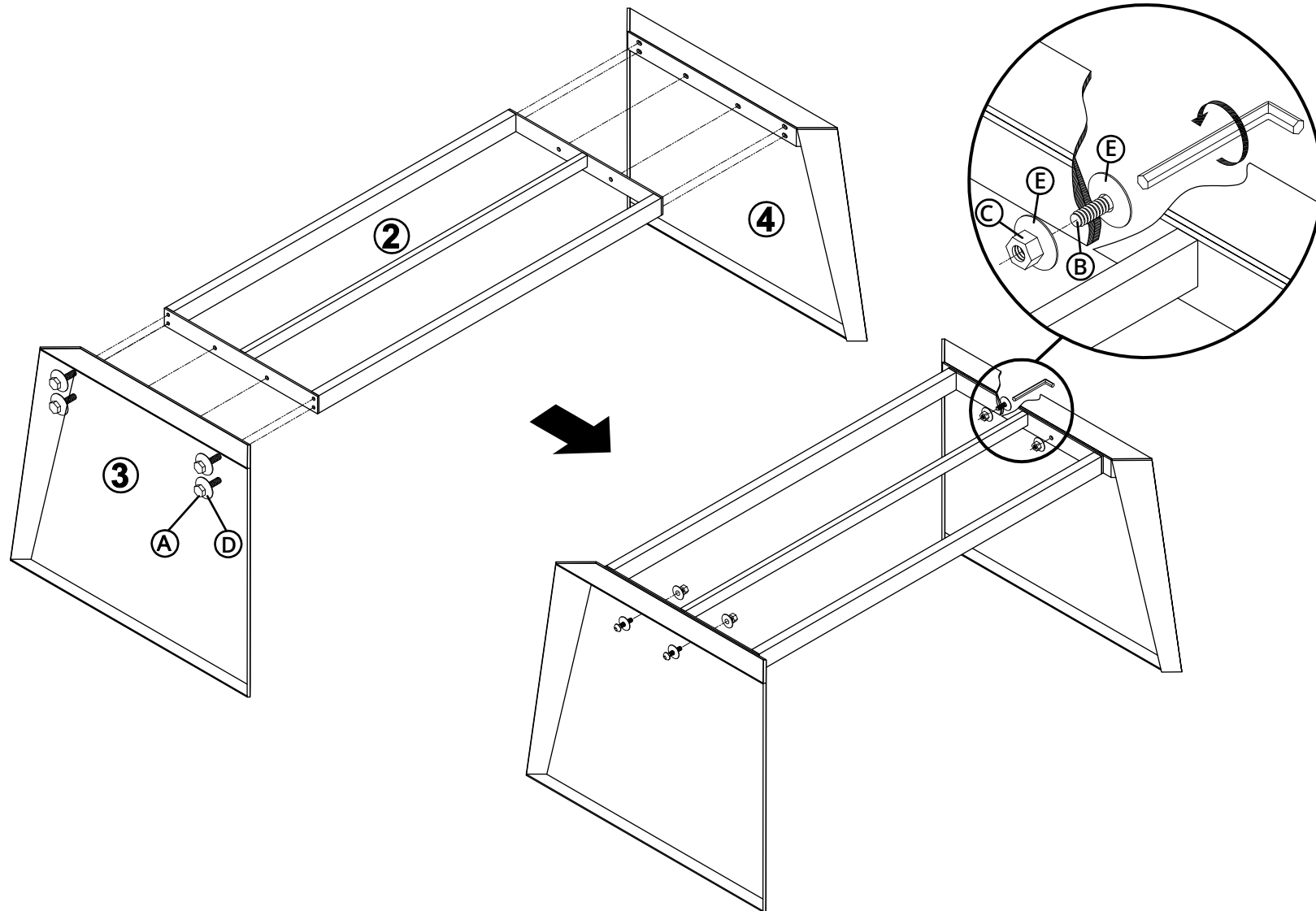

ASSEMBLY INSTRUCTION

