

# RUSH

## ELEMENT RANGEMENT 1PO N°02

**NOTICE DE MONTAGE**  
ASSEMBLING INSTRUCTIONS  
MONTAGEANLEIUNG  
MANUAL DE MONTAJE  
MONTAGEVOORSCHRIFT  
INSTRUÇÕES DE MONTAGEM  
ISTRUZIONI DI MONTAGGIO  
ИНСТРУКЦИЯ ПО СБОРКЕ  
Naputci za montažu

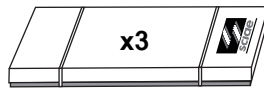
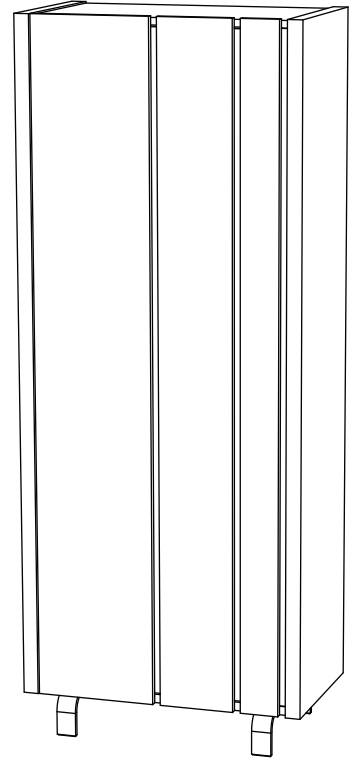
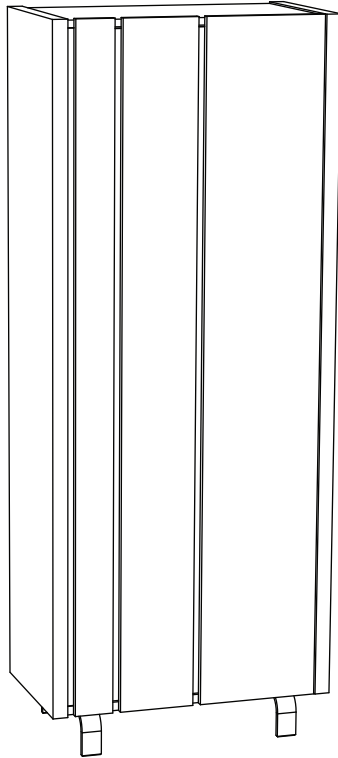

Package 1: 17 Kg  
Package 2: 36 Kg  
Package 3: 19 Kg

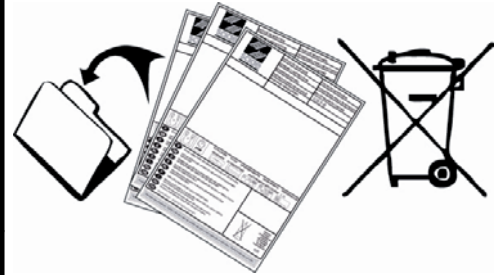

**F** POUR L'APRES-VENTE, RETOURNEZ AU MAGASIN AVEC CETTE NOTICE

**GB** FOR THE AFTER SALES, GO BACK TO THE SHOP WITH THIS ASSEMBLY INSTRUCTION

**D** WENDEN SIE SICH BITTE AN IHREN HANDLER UND GEBEN SIE IHM DIE KENNUMMER DES MOBELS UND DIE TEILNUMMER

**E** EN CASO DE SERVICIO POST-VENTA DEBEN DE VOLVER A LA TIENDA CON LAS INSTRUCCIONES DE MONTAJE

**NL** VOOR SERVICE NA VERKOOP, GA NAAR UW LEVERANCIER MET DEZE MONTAGE HANDLEIDING

**P** PARA O POS VENDA, VOLTE A LOJA COM ESTA FOLHA

**I** SERVIZIO POST VENDITA: E NECESSARIO PRESENTARSI SUL PUNTO VENDITA CON QUESTE ISTRUZIONI DI MONTAGGIO

**RU** ДЛЯ ПОСЛЕПРОДАЖНОГО ОБСЛУЖИВАНИЯ ПРОСЬБА ОБРАТИТЬСЯ В МАГАЗИН ПРЕДЪЯВИВ НАСТОЯЩУЮ ИНСТРУКЦИЮ ПО СБОРКЕ

**HR** U SLUČAJU REKLAMACIJE, VRATITE SE NA PRODAJNO MJESTO S OVIM UPUTAMA ZA MONTAŽU

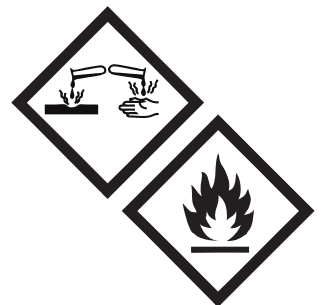
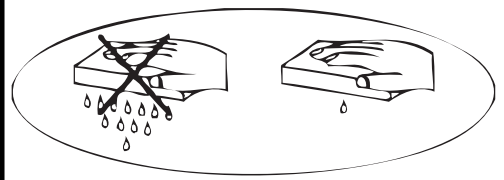

	+40°C +104°F	
	HYGROMETRIE HYGROMETRY 40%-65%	
	+15°C +59°F	

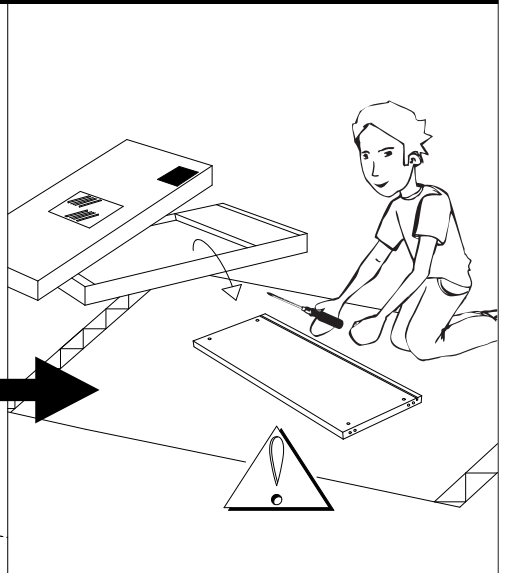
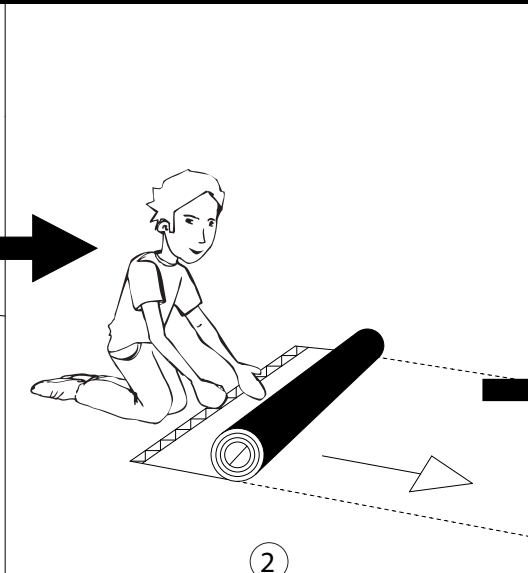
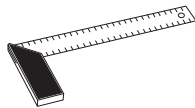
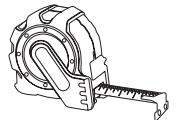
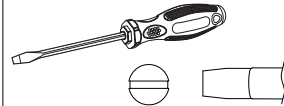
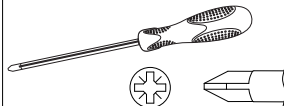
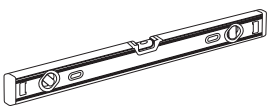
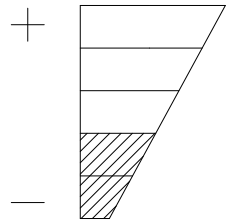
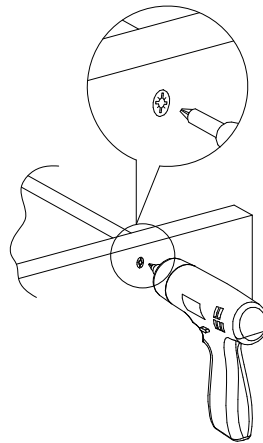
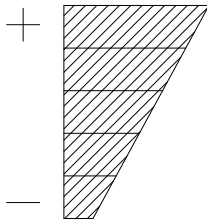
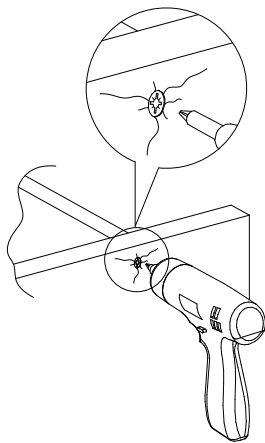
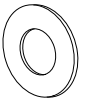
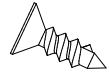
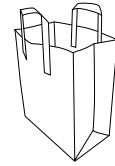
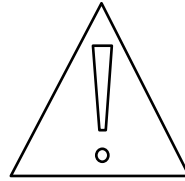

1 an  
1 year

OK

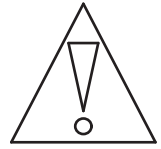
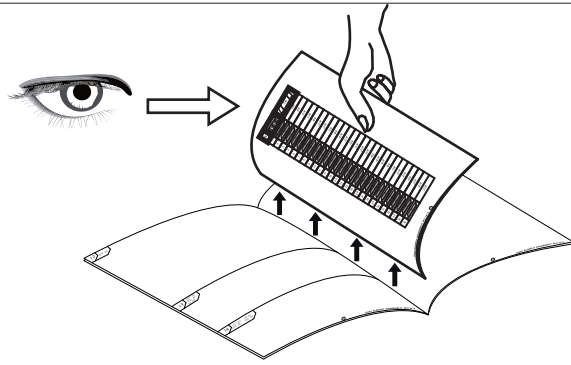

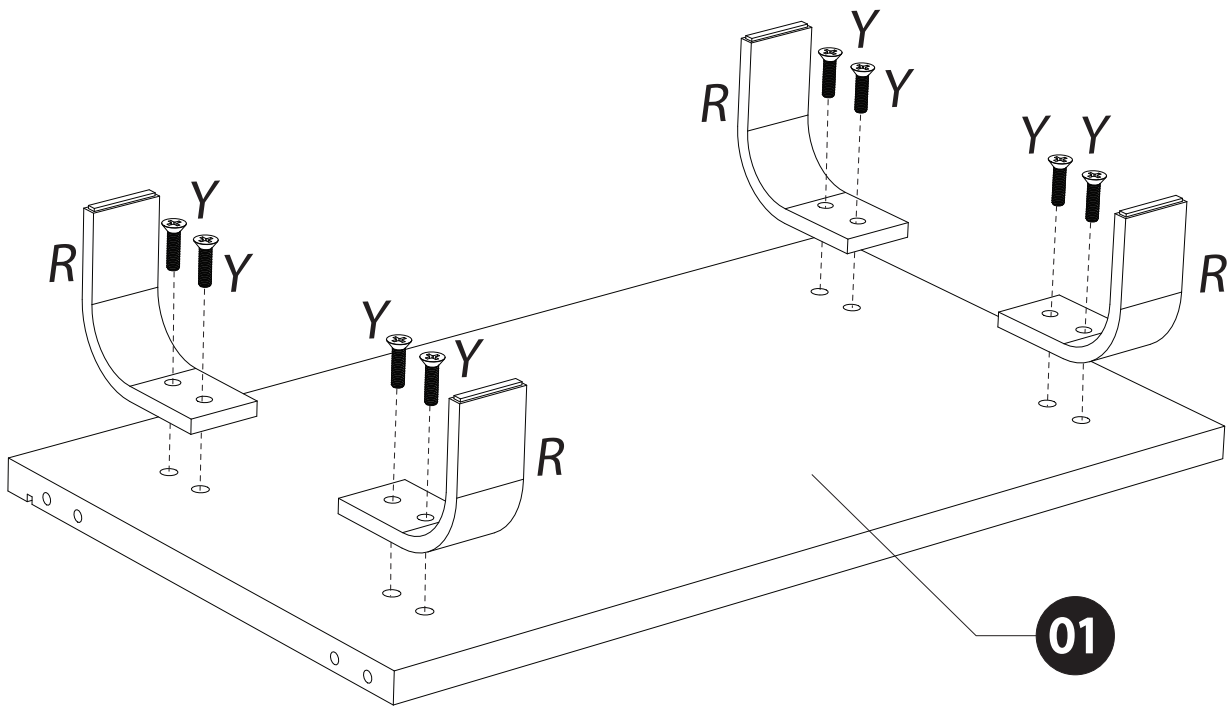
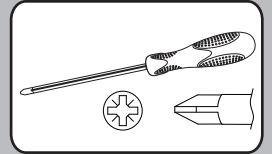
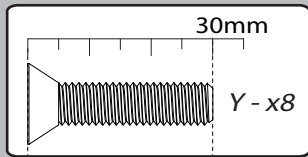
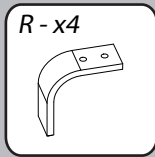

1



2

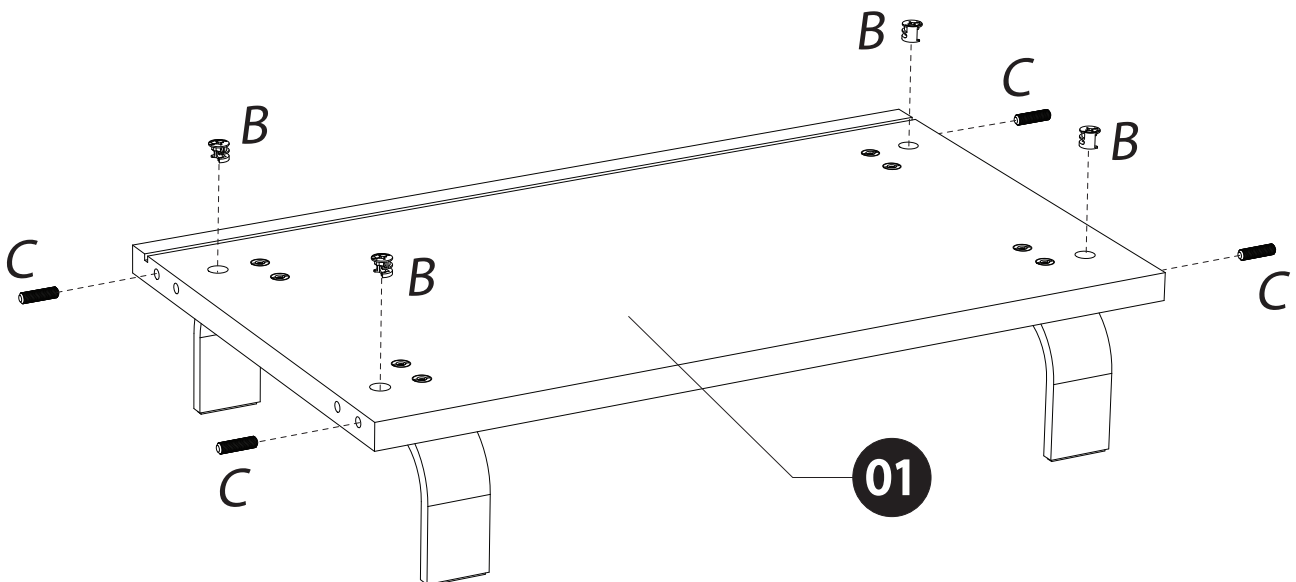
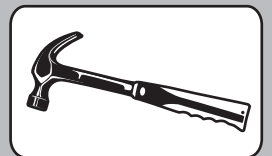
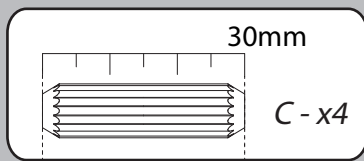
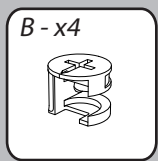

3

RUSH ELEMENT RANGEMENT 1PO N°02

3

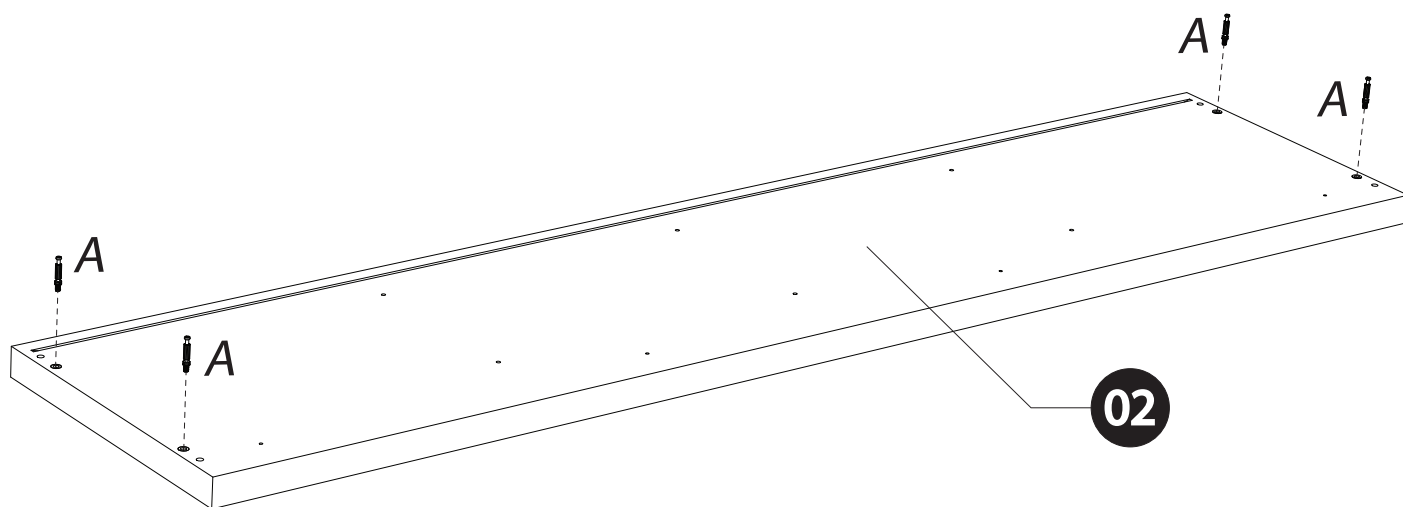
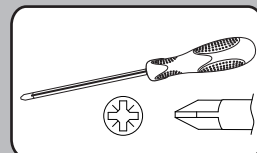
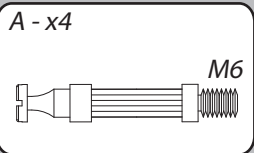

4

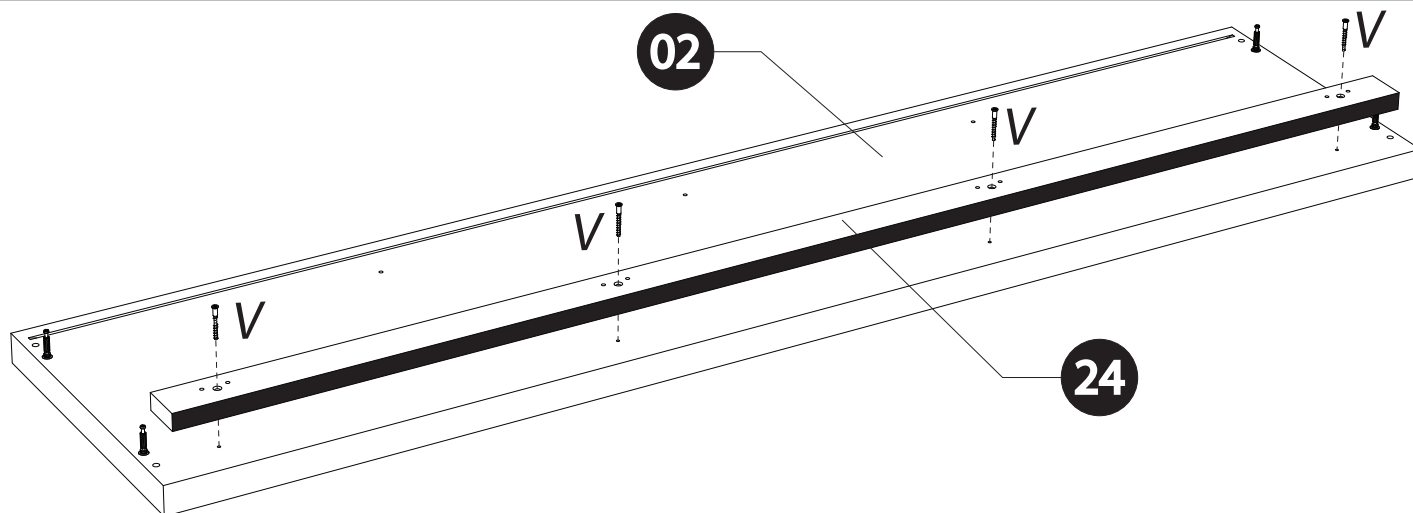
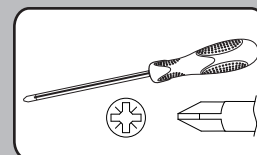
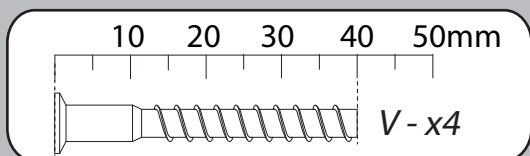

5

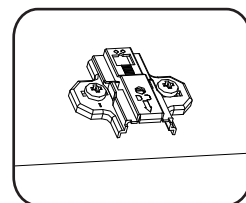
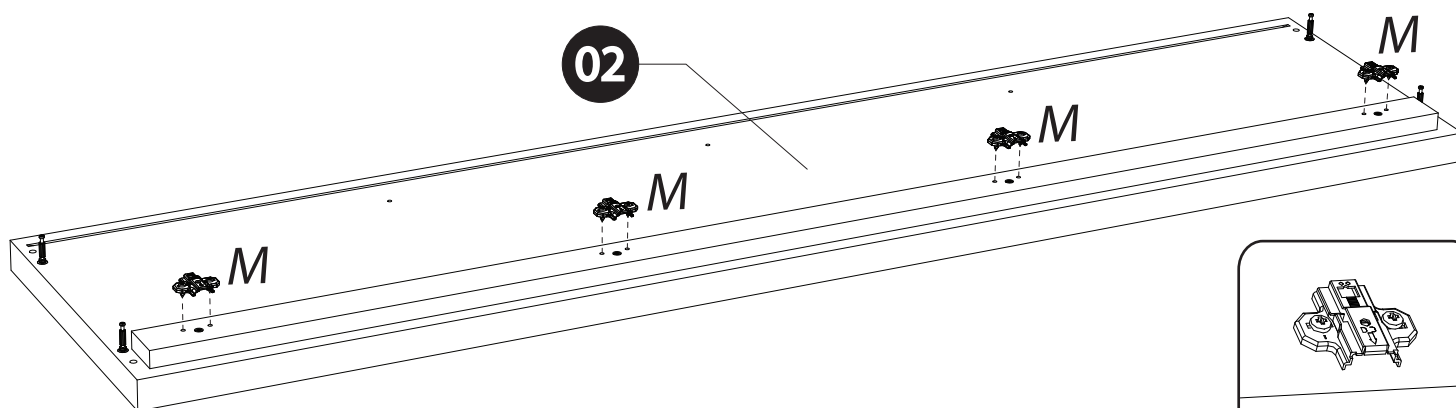
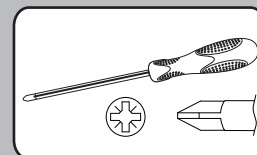
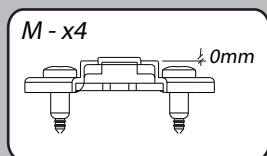

# 6

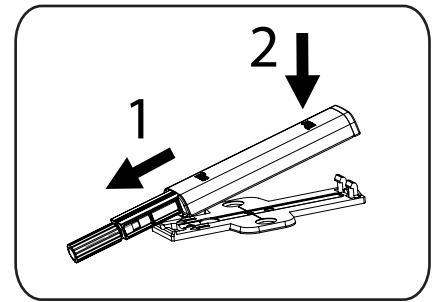
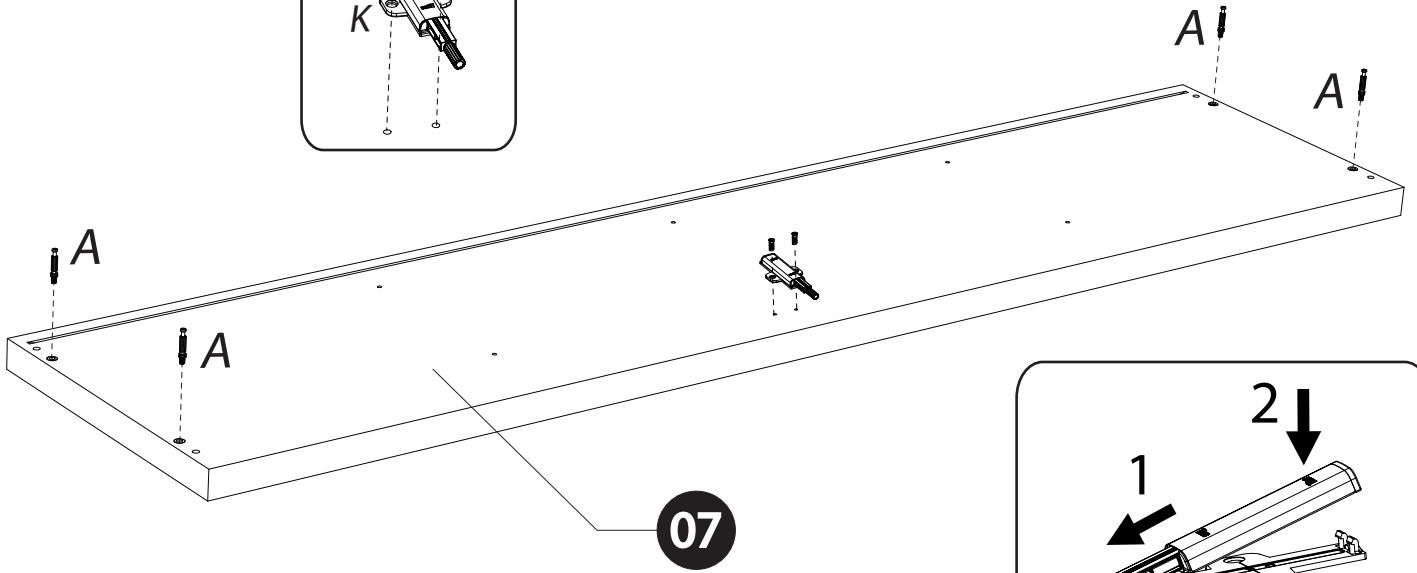
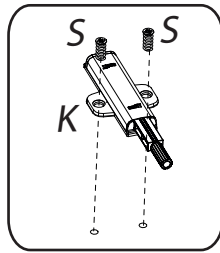
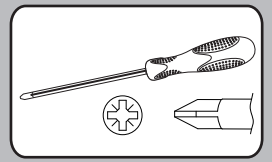
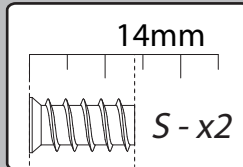
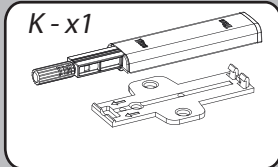
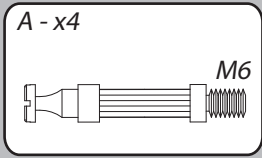

# 7

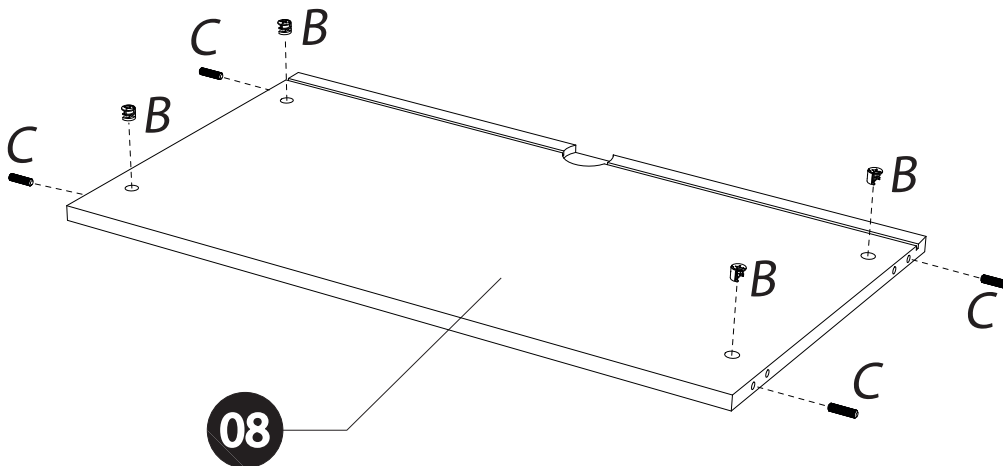
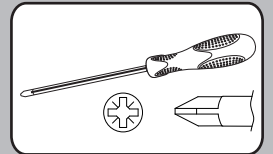
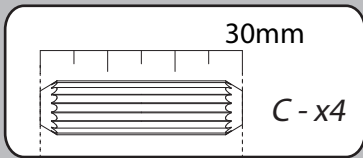
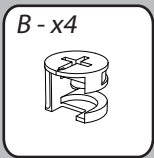

# 8

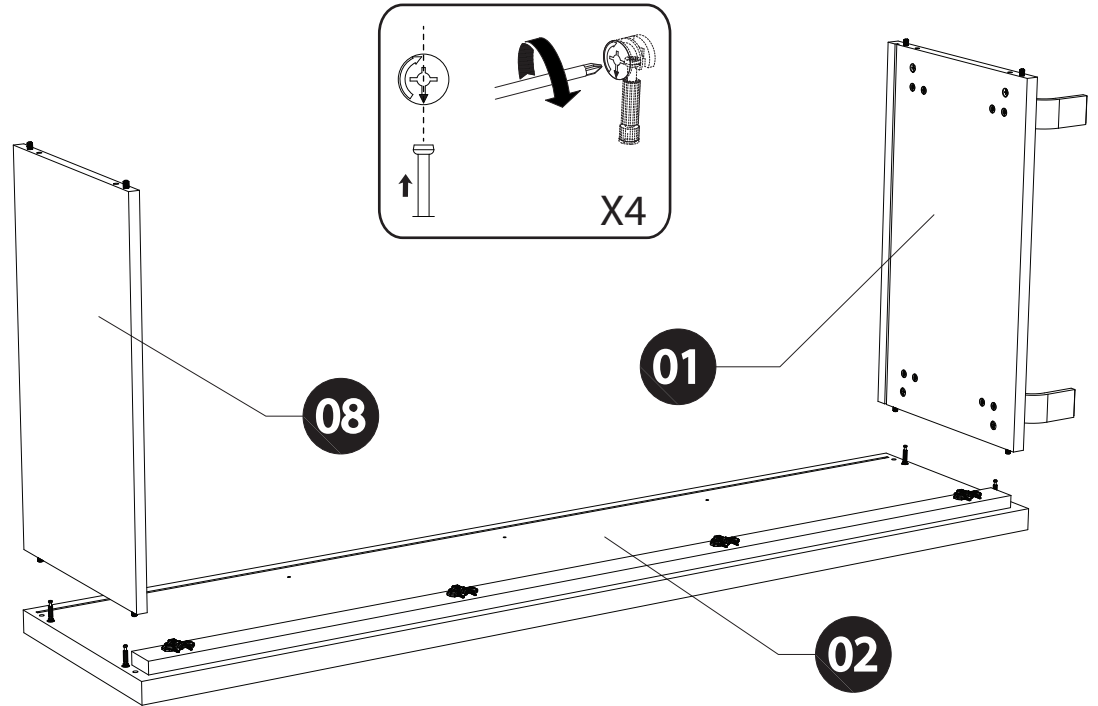
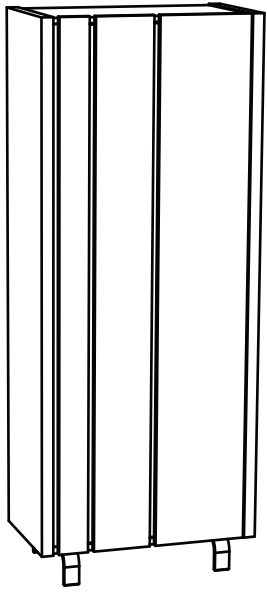
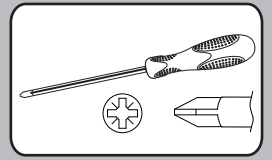

# 8 bis

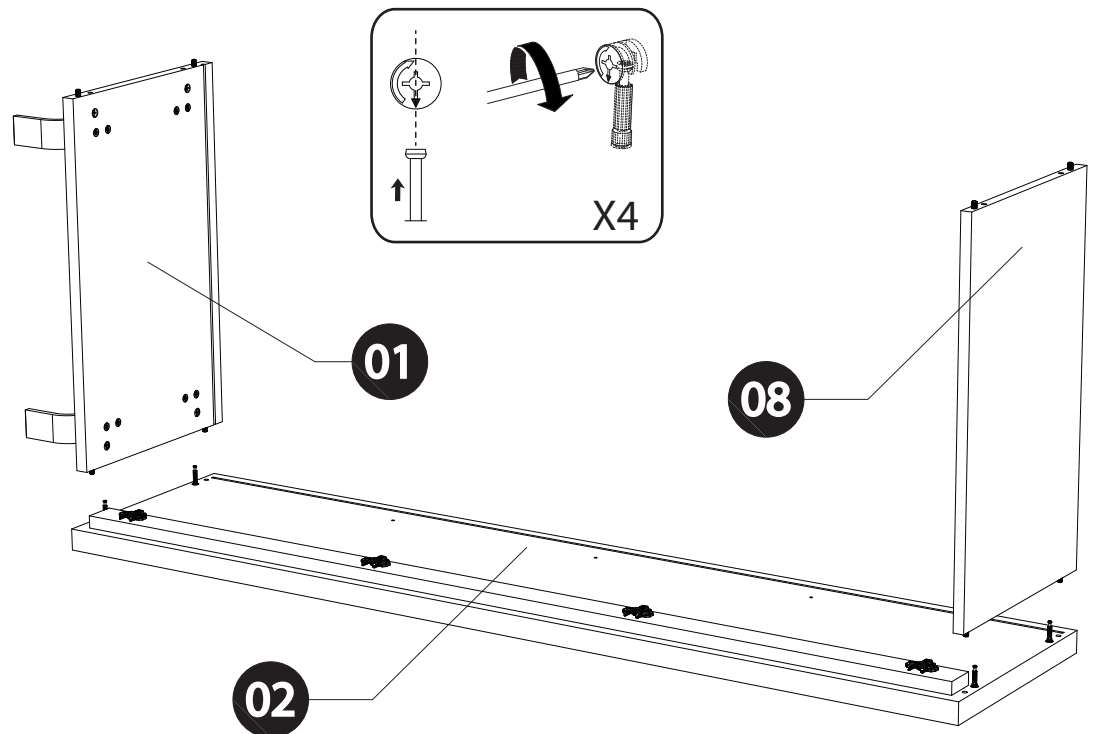
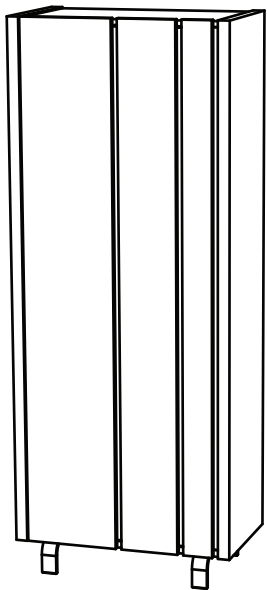
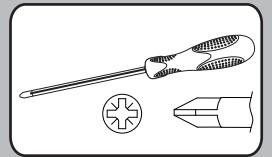

9

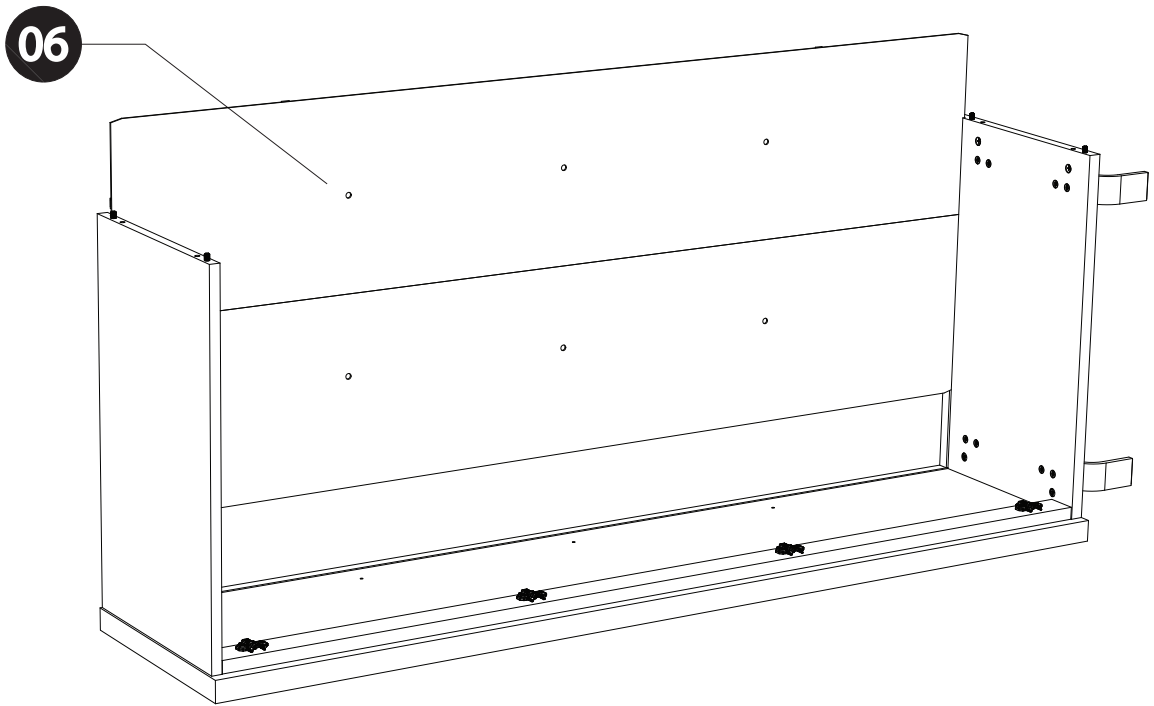

10

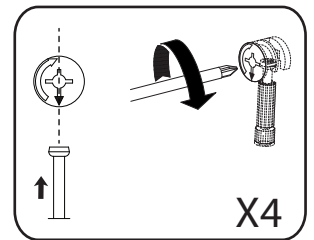
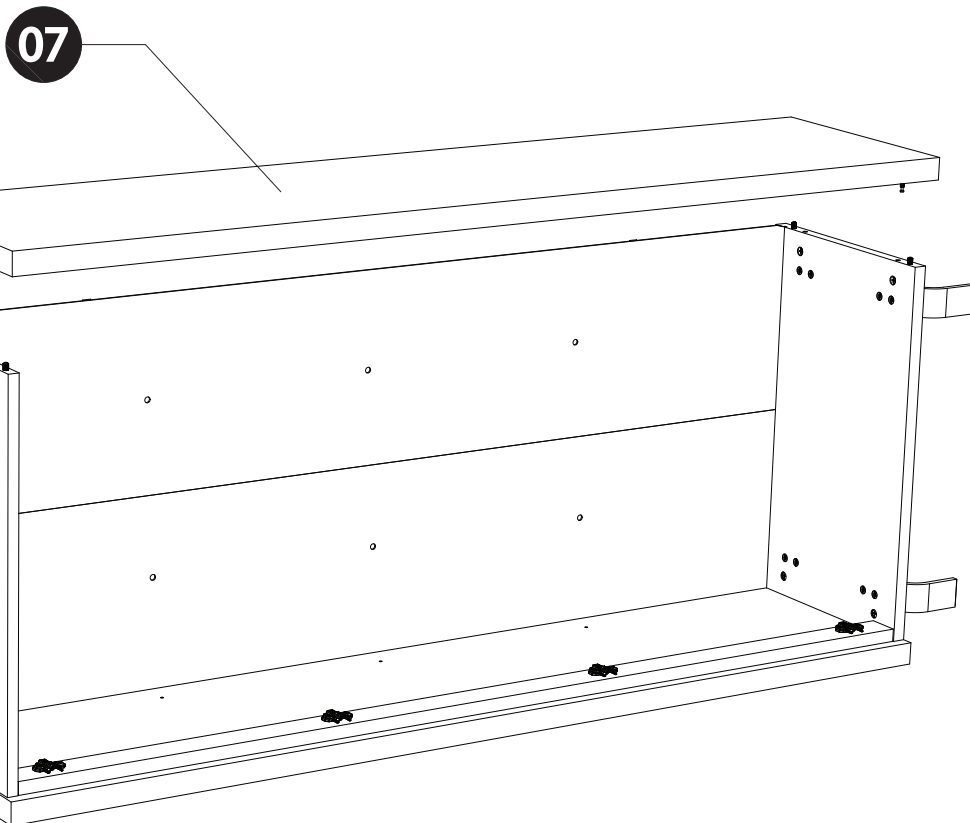
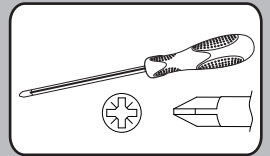

7





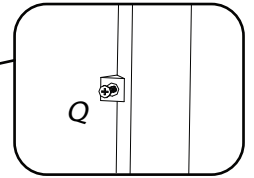
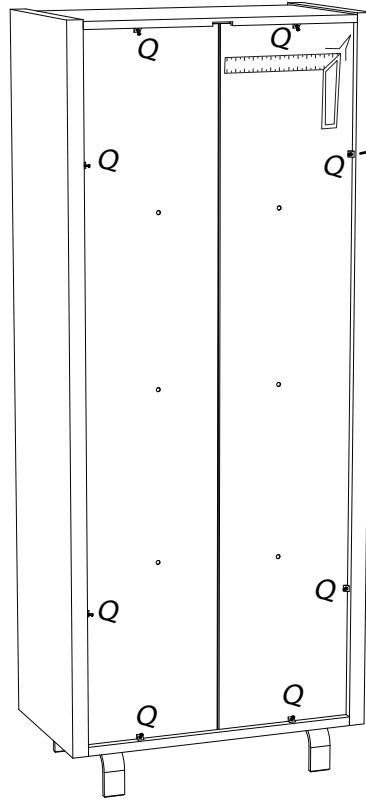
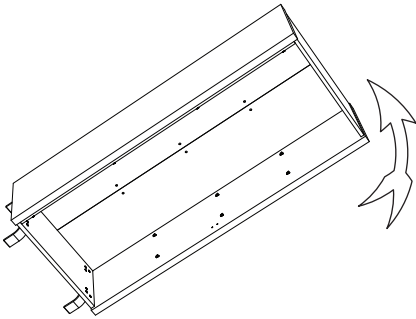
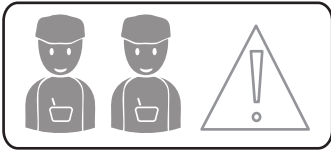
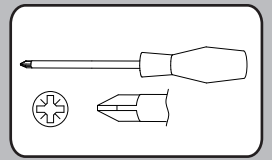
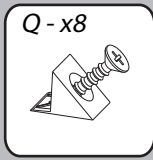



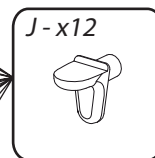
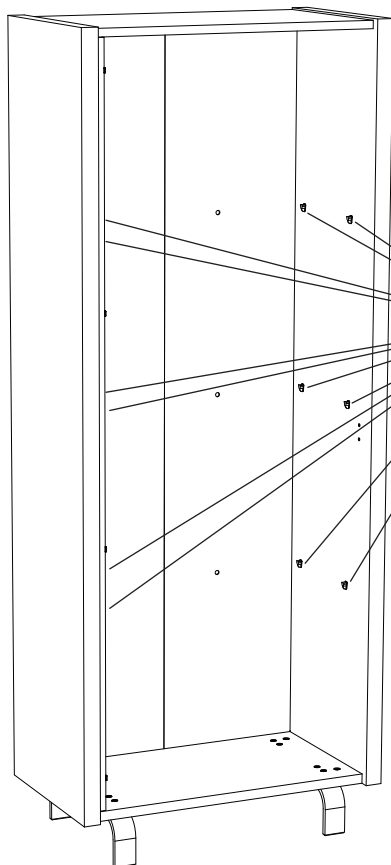
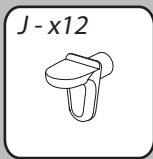

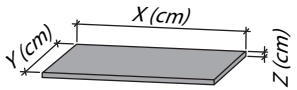
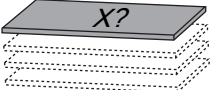
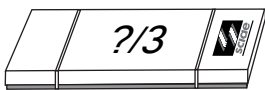

RUSH ELEMENT RANGEMENT 1PO N°02

# 11



# 12



<i>DESIGNATION</i>		N°		
Dessous	65,4 x 38,5 x 2,2	1		1
Côté gauche	172 x 40,5 x 3,8	2		2
Derrière pliant	168,5 x 66,3 x 0,25	6		2
Côté droit	172 x 40,5 x 3,8	7		2
Dessus	65,4 x 38,5 x 1,8	8		1
Tablettes	65,2 x 30 x 1,6	9		1
Recharge de porte	166,8 x 43,4 x 1,2	10		3
Recharge d'embase	167,5 x 5,5 x 2,2	24		3
Habillage gauche de porte	172 x 9,7 x 1,6	27		3
Habillage centrale de porte	172 x 19 x 1,6	30		3
Habillage droit de porte	172 x 30,4 x 1,6	31		3

27

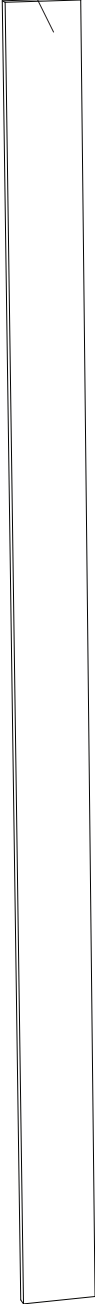

30

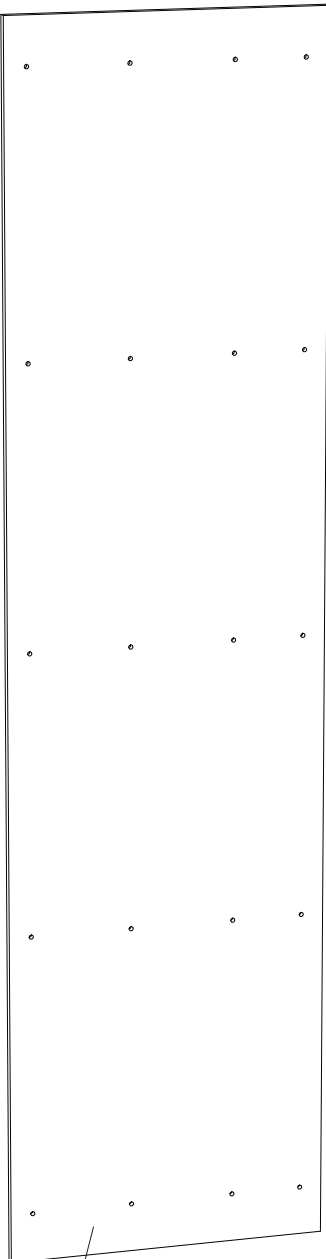
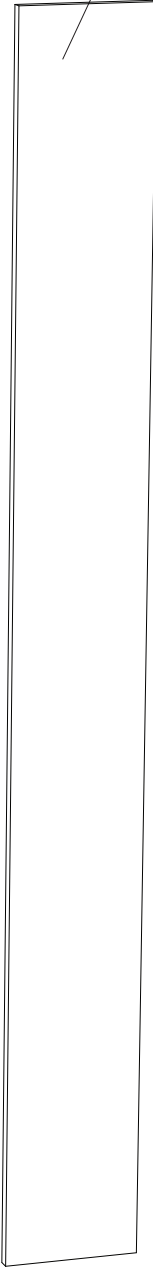

10

31

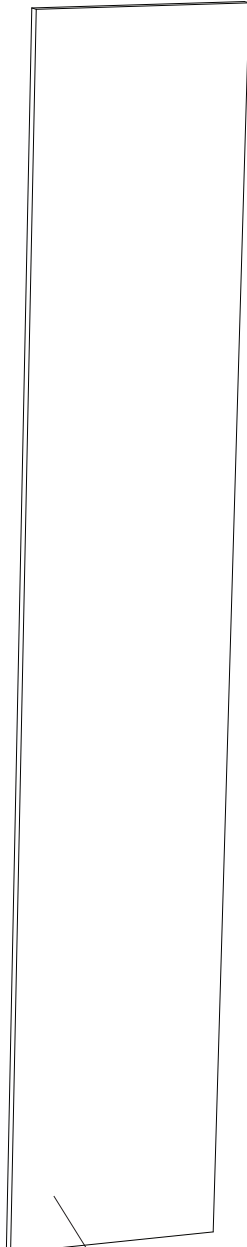

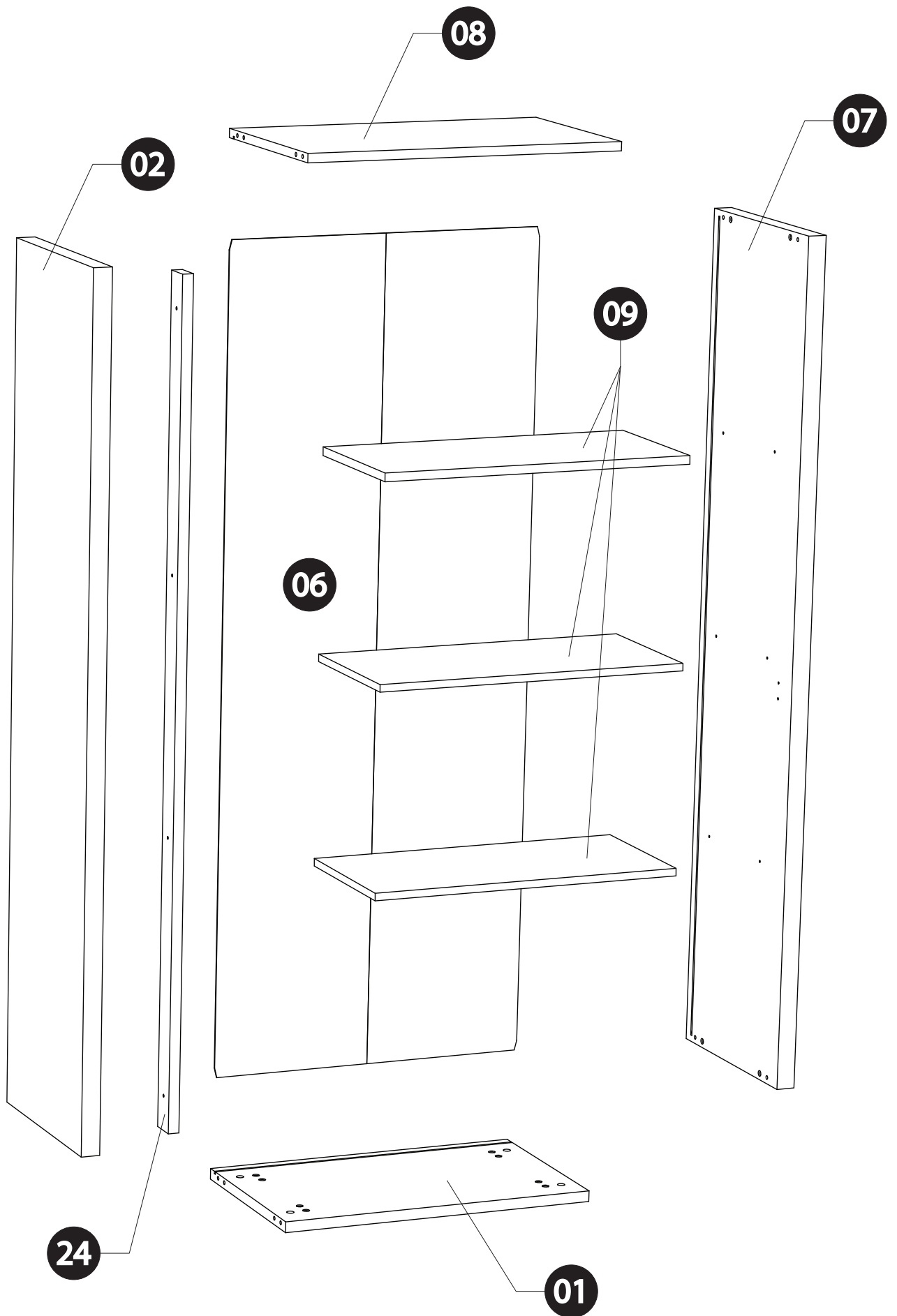

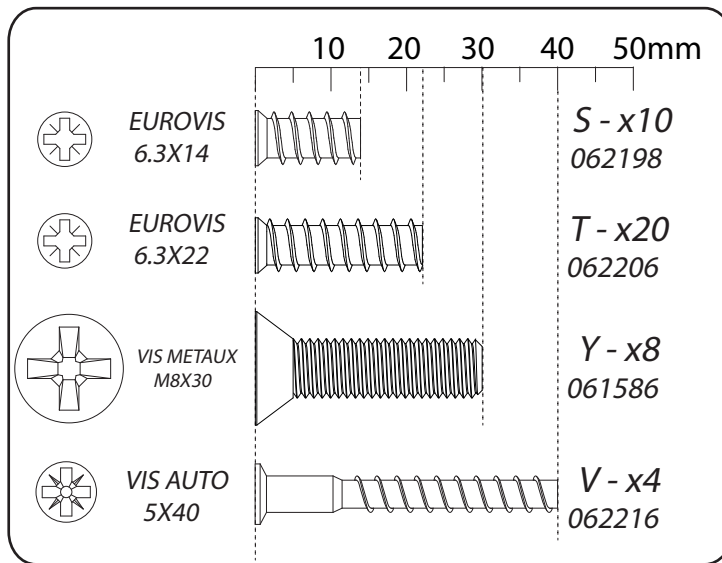
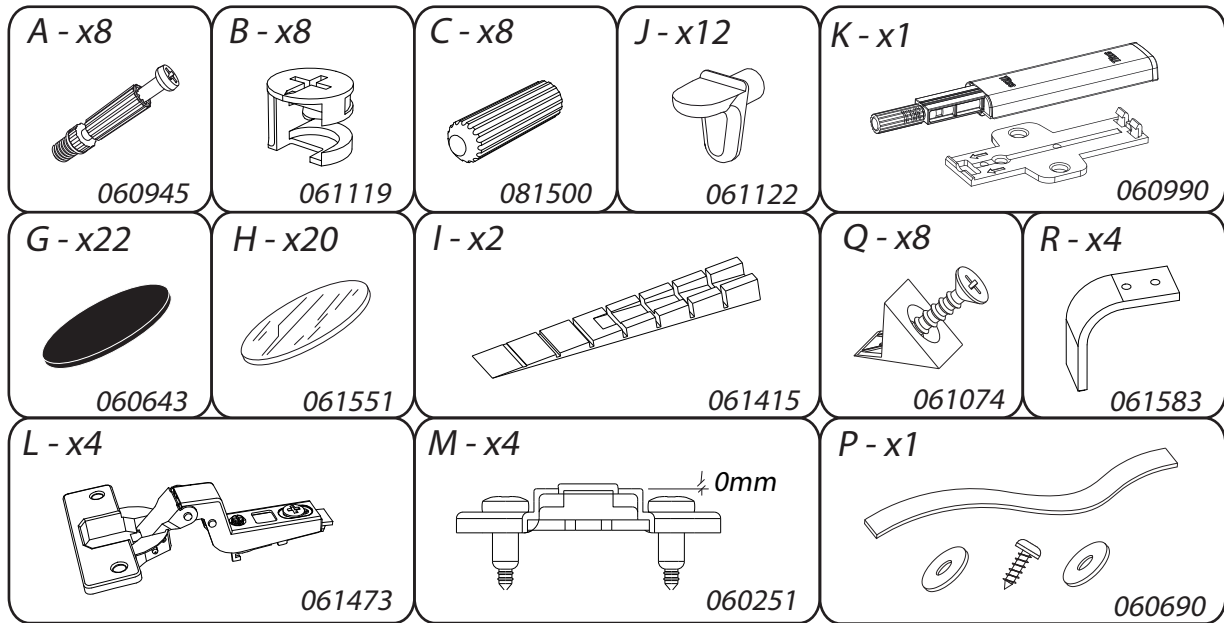

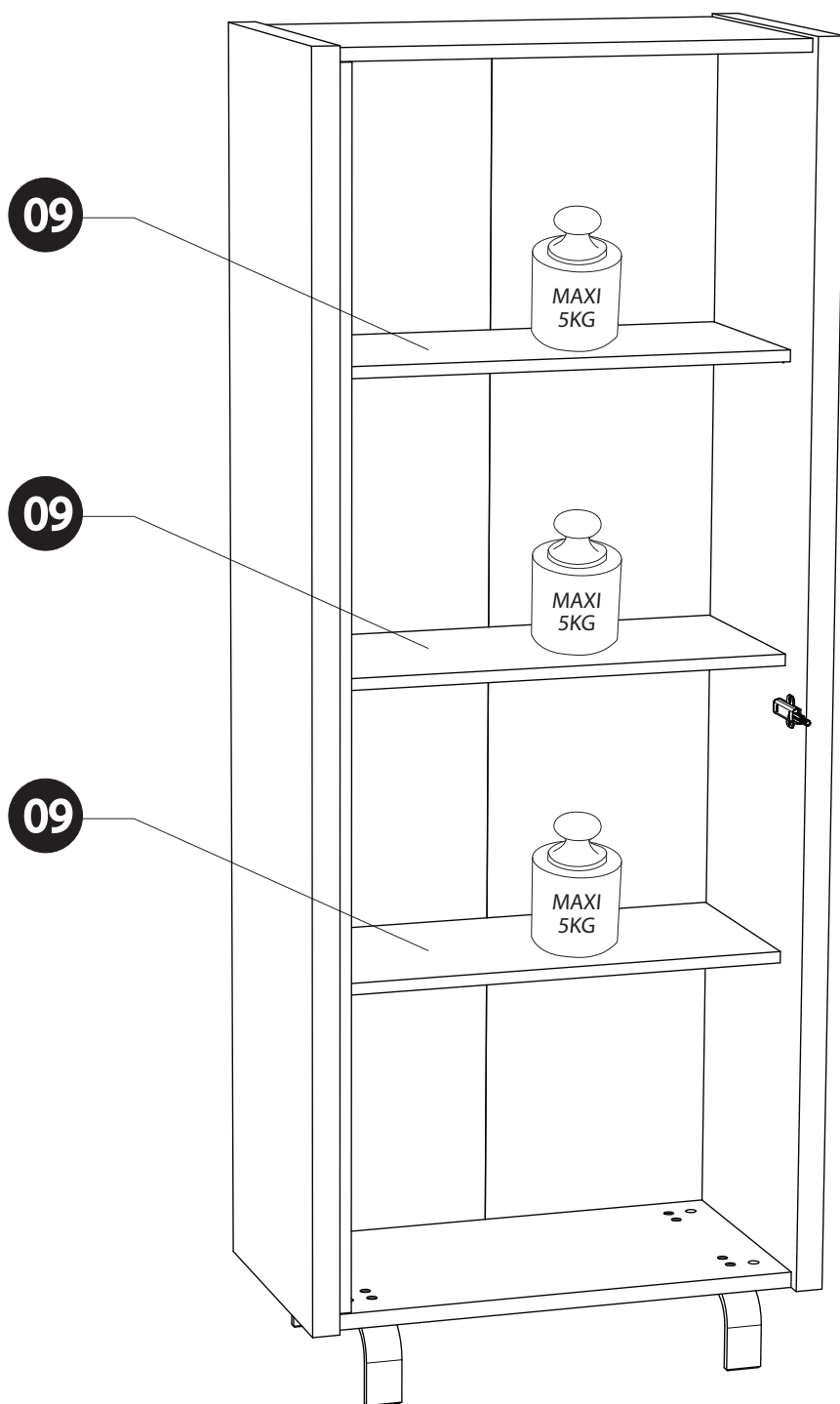

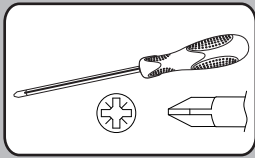
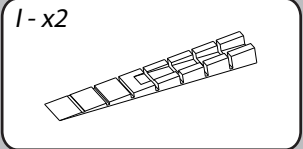
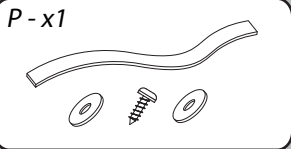

FRANCAIS: Pour votre sécurité il est impératif de fixer votre meuble au mur.  
 ENGLISH: For your own safety, this furniture must be fastened to the wall imperatively.  
 DEUTSCH: Zu Ihrer Sicherheit, ist es notwendig Ihr Möbel auf dem Wand zu fixieren.

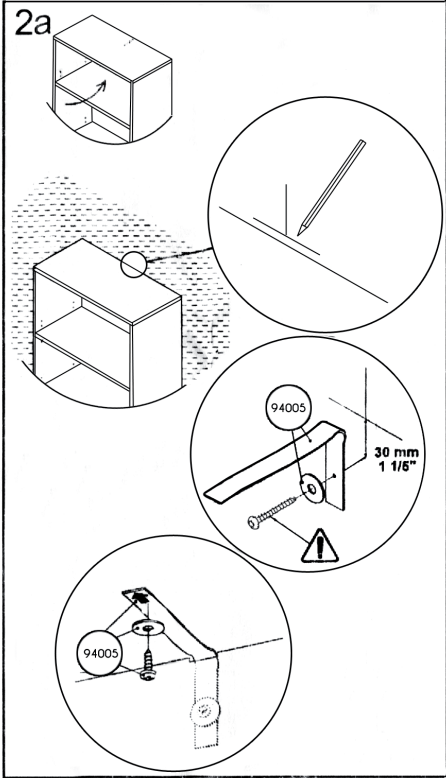
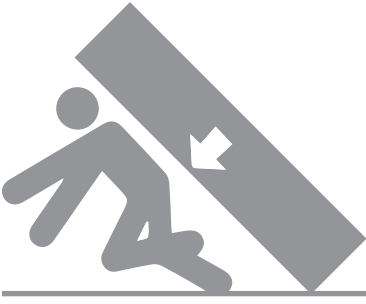

FRANCAIS  
**IMPORTANT:** La vis fournie avec le dispositif anti-bascule est destinée à fixer le dispositif dans le meuble. Pour la fixation au mur, compléter par une vis adaptée au support mural. En cas de doute, contacter un magasin de bricolage.

ENGLISH  
**IMPORTANT:** The screw supplied together with the anti-topple bracket is to be used only for fixing the anti-topple bracket to the furniture. In addition to this, you will need to choose a screw or fitting which is suitable for securing the bracket to the kind of walls you have. If you are unsure about what type of screw to use contact your local hardware store.

DEUTSCH  
**WICHTIG:** Die dem kippschutz beigefügten schrauben sind ausschließlich für die befestigung des kippschutzes am möbelstück vorgesehen. Für die befestigung des kippschutzes an der wand benötigen sie zusätzlich schrauben oder beschläge, die zur beschaffenheit der wand passen. Falls sie nicht sicher sind, welche art von schrauben geeignet sind, wenden sie sich bitte an den fachhandel.

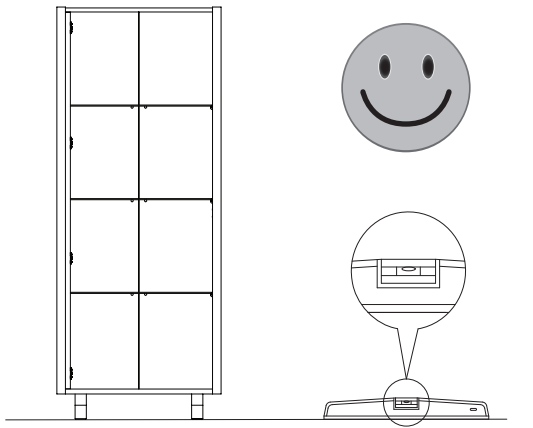
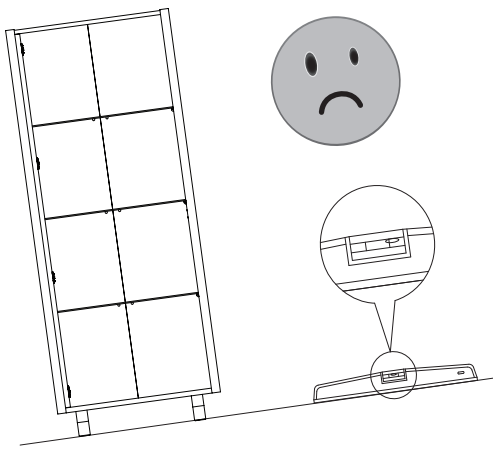
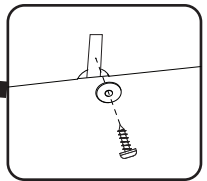
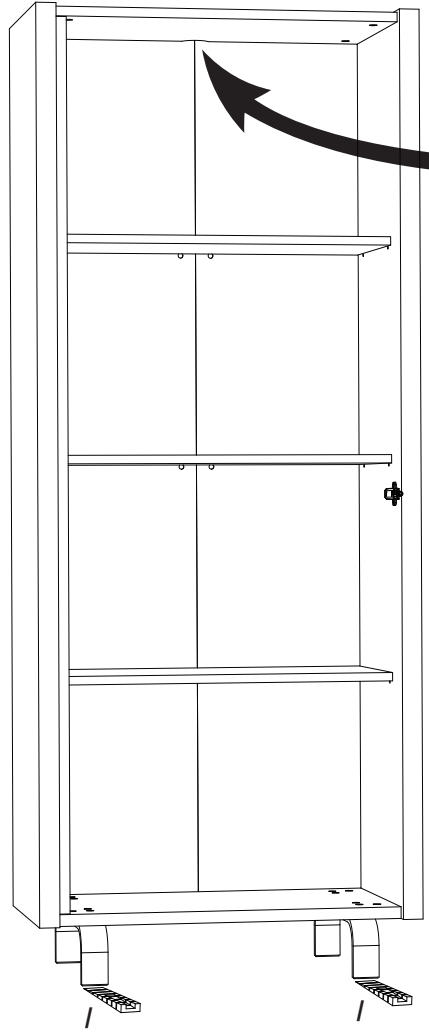

# 15

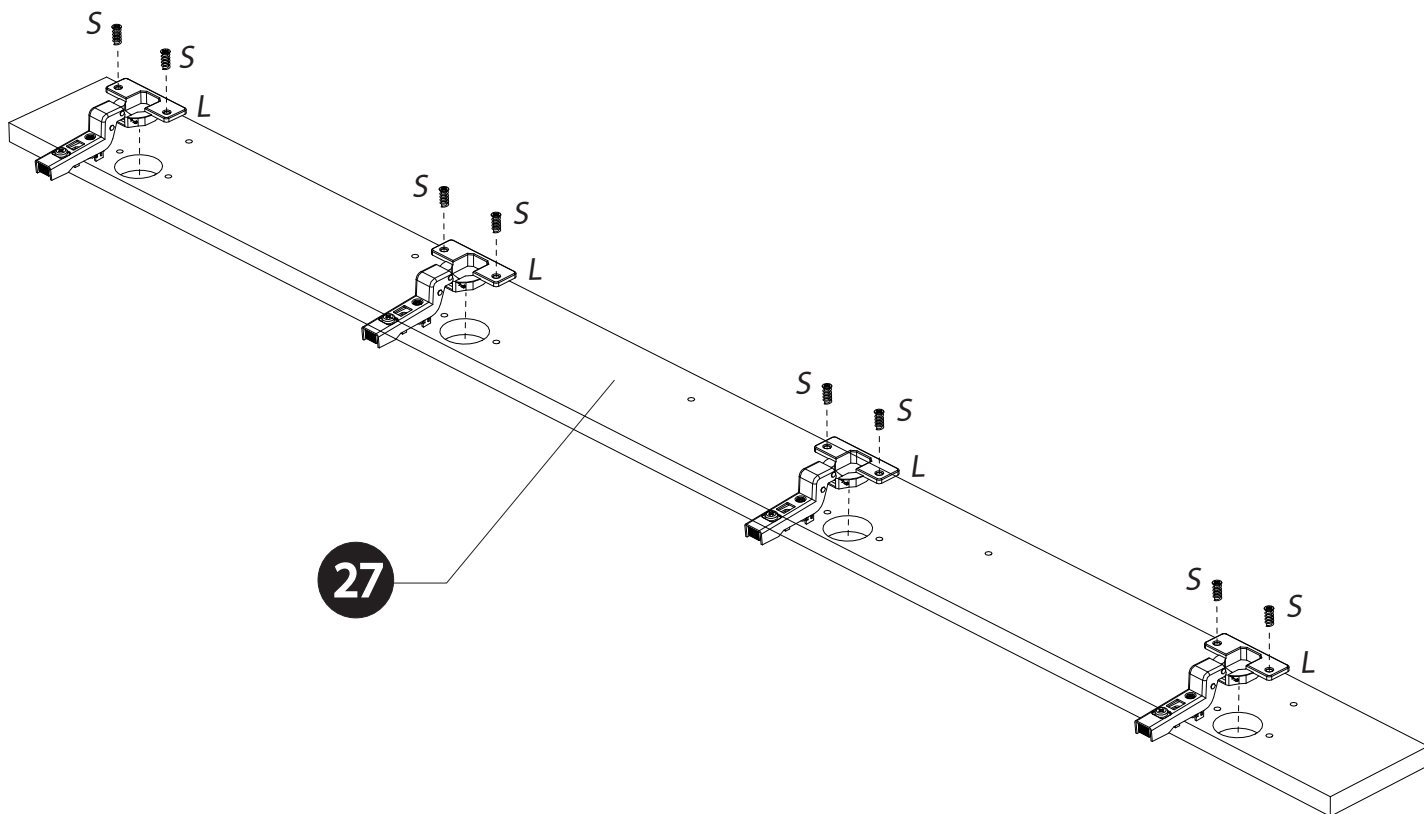
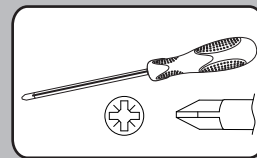
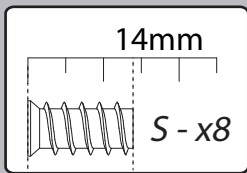
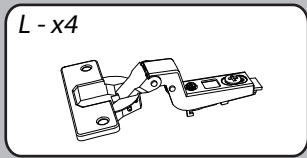

# 16

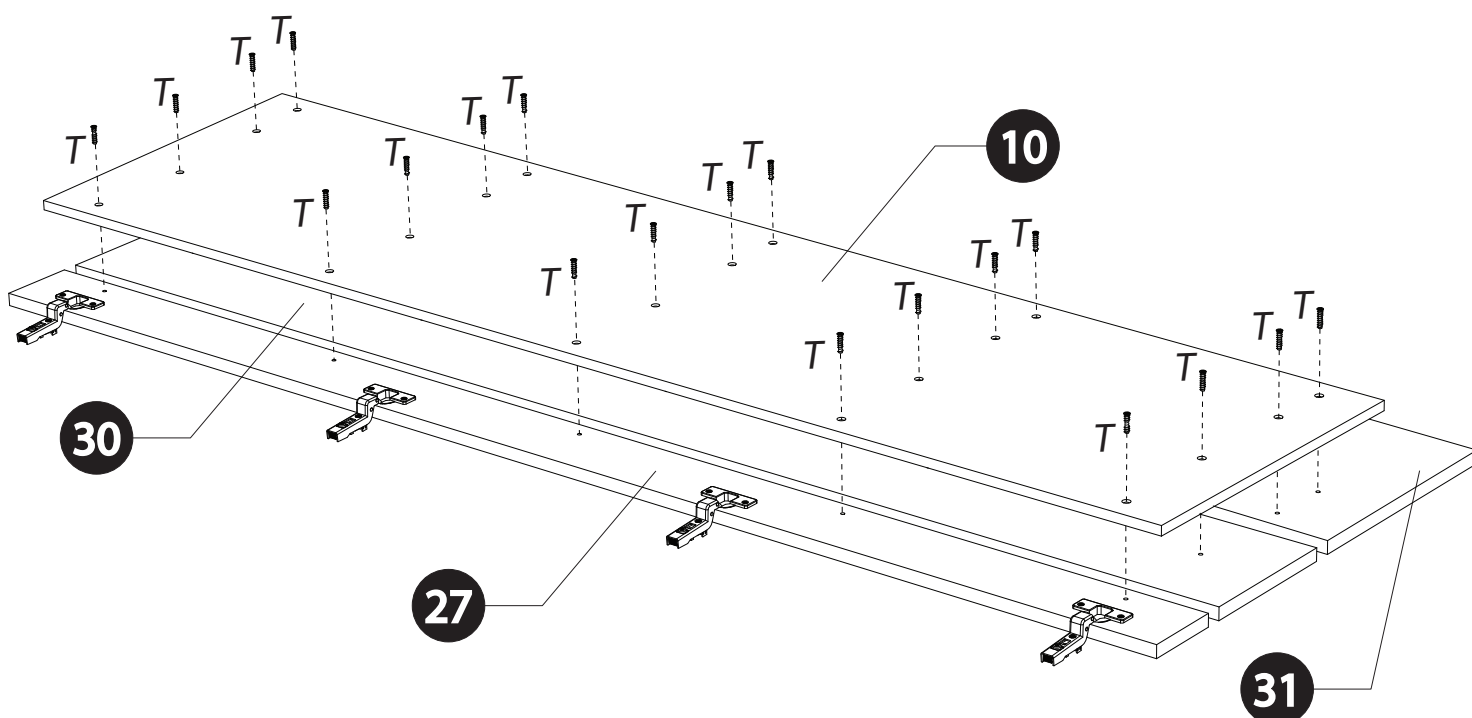
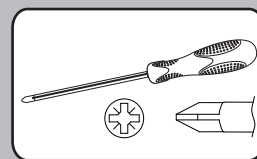
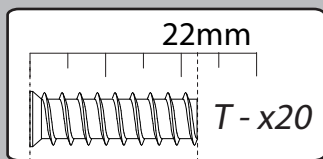

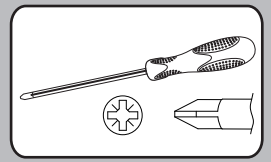

31

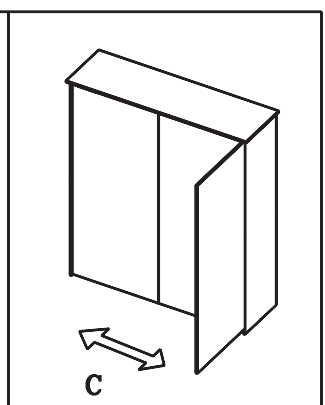
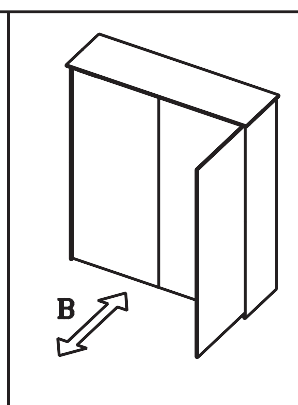
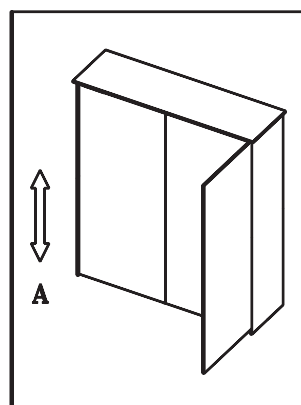
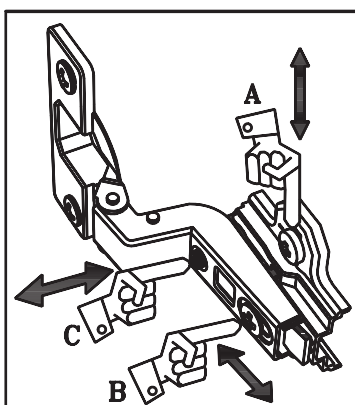
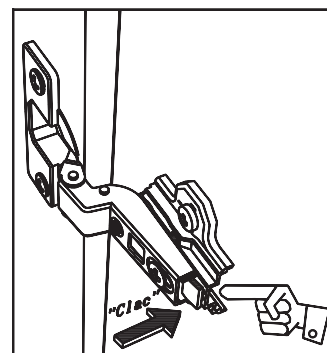
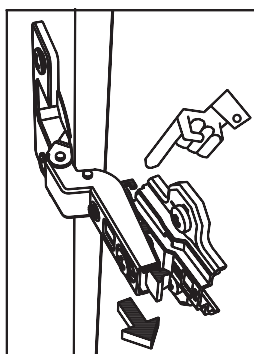
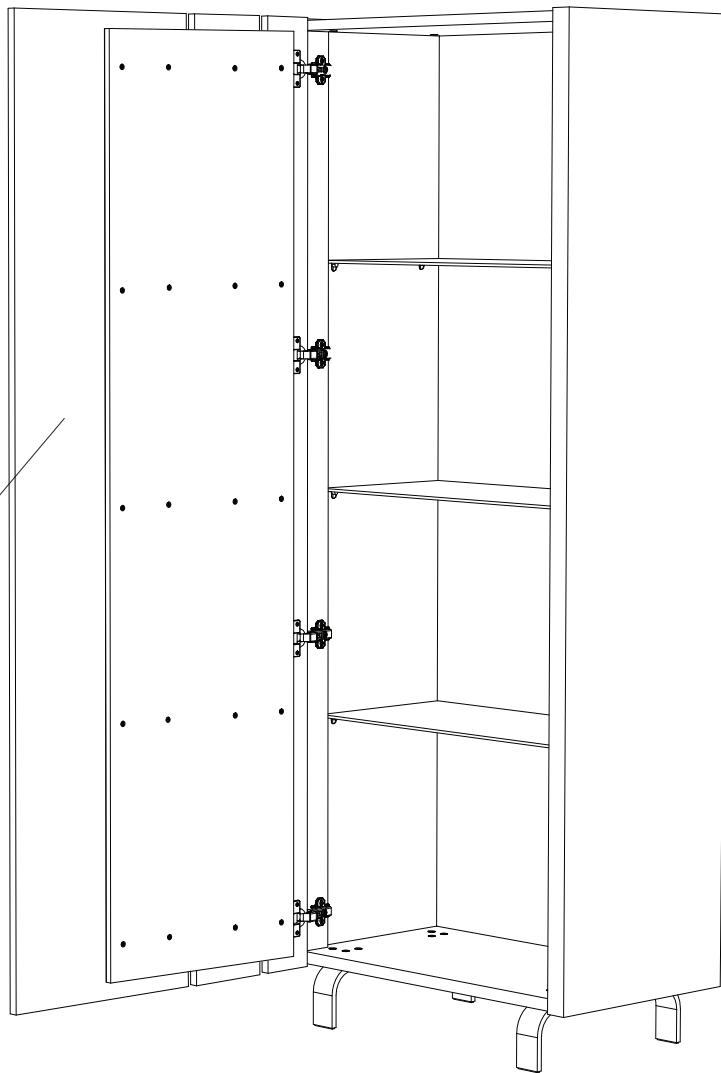

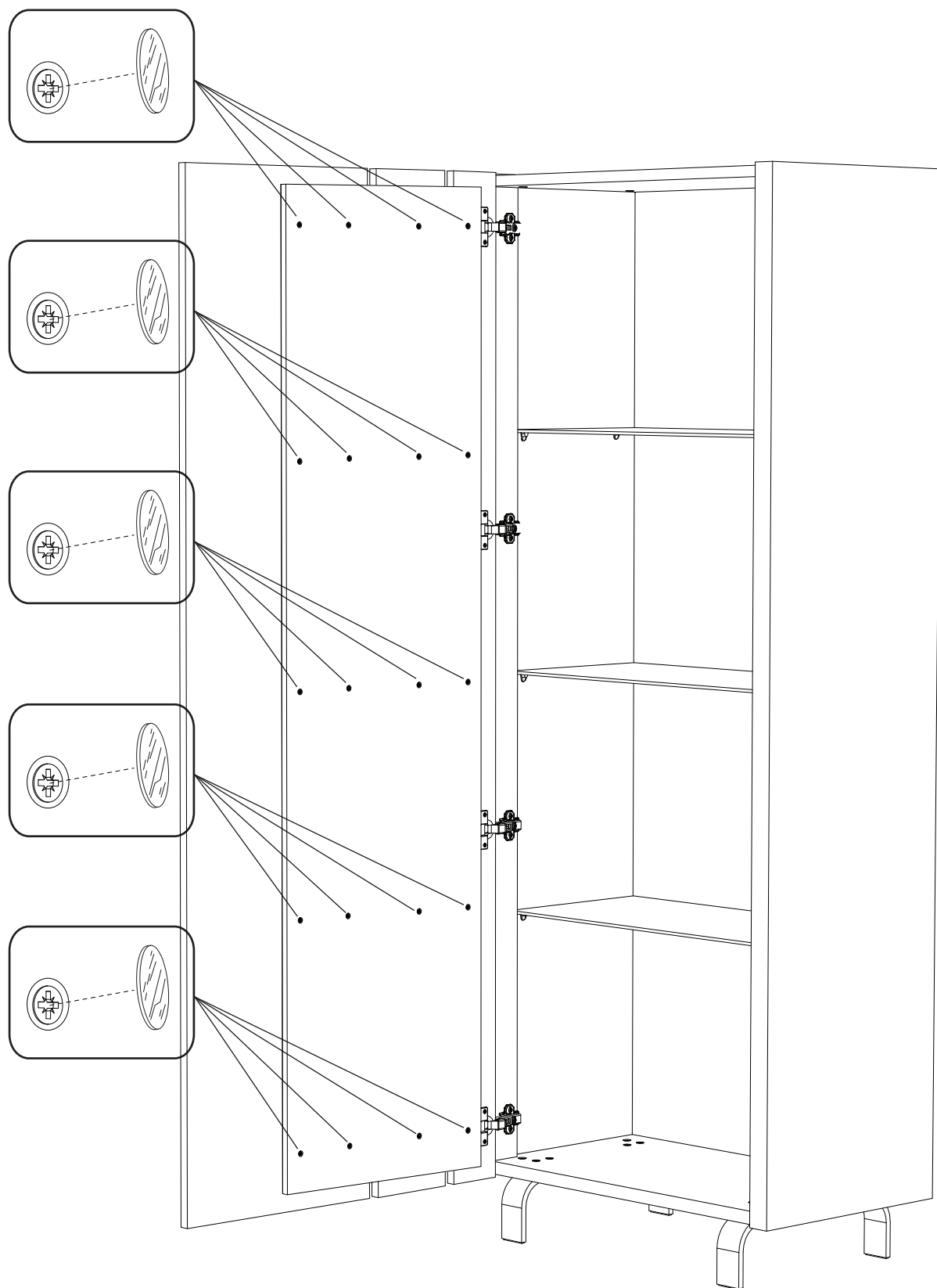
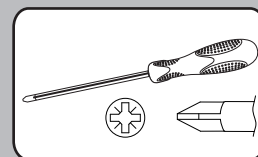
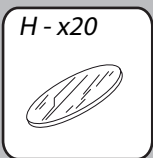

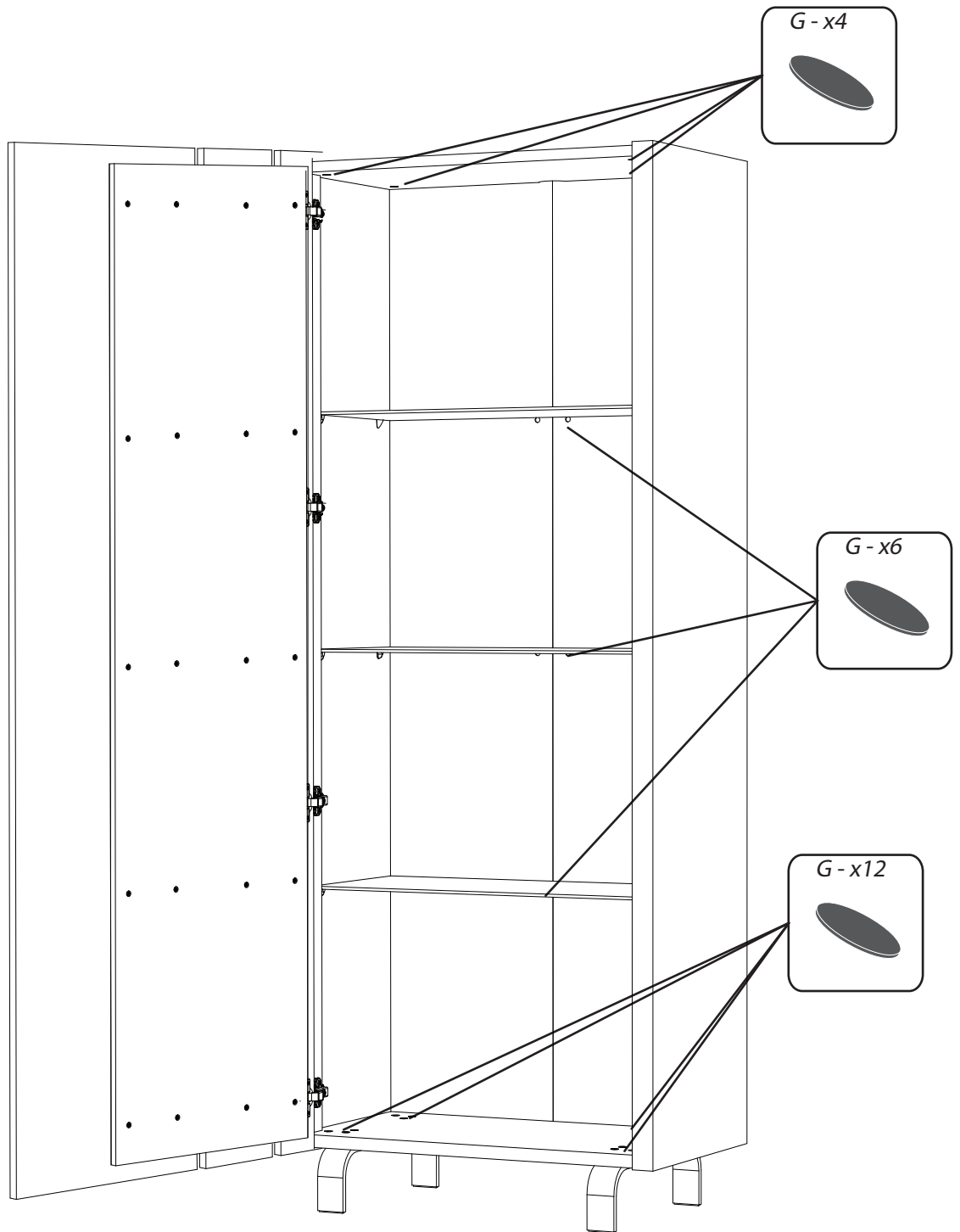
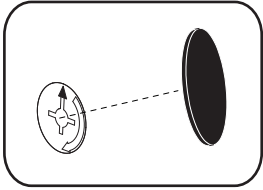

G - x4

G - x6

G - x12

## FRANCAIS

Recommandations de démontage :

En cas de déménagement, il convient de procéder au démontage de votre meuble, en ôtant toute la visserie.

## ENGLISH

Disassembly advices:

In case of moving, it is needed to dismantle the furniture removing the fittings.

## DEUTSCH

Empfehlungen für die Demontage:

Bei Transport bitte alle Beschläge demontieren.

Element rangement 1po composé de panneaux de particules  
revêtus papier décor chêne et papier noir uni.

Panneaux de particules mélaminés décor ardoise noir métallisé pour le dessus.

L.73 cm - H.183 cm - P.40,5 cm.

A monter soi-même.

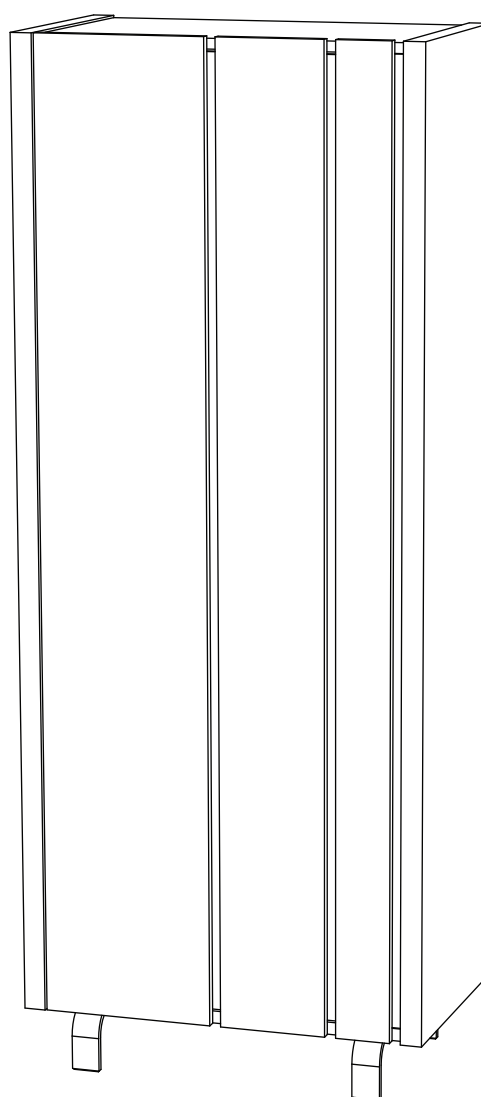
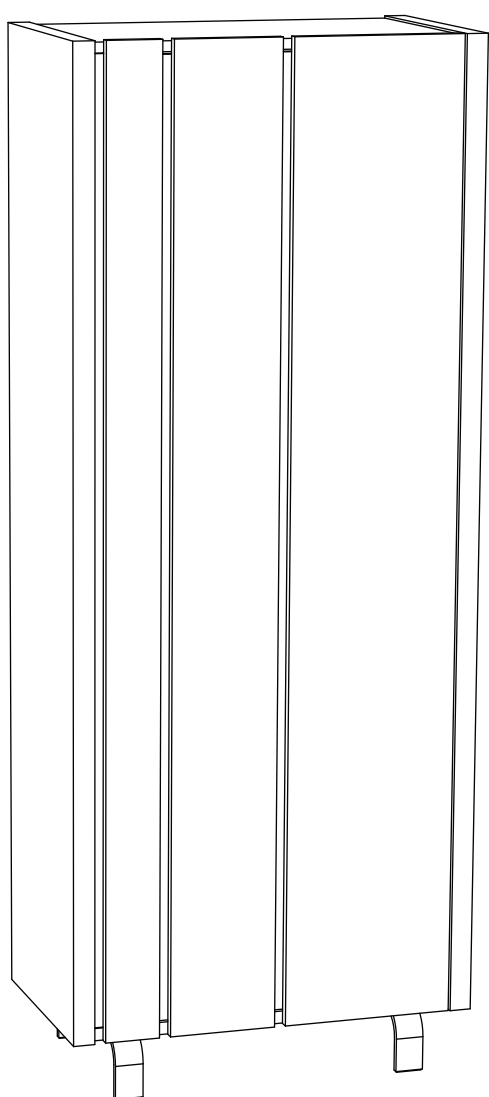

"Les meubles contenant des panneaux à base de bois (panneaux de particules, panneaux de fibres, contreplaqué...) peuvent émettre des substances polluantes dans l'air intérieur. Il est ainsi recommandé, après l'installation du meuble dans son logement, d'aérer fréquemment la pièce concernée pendant au moins quatre semaines afin de réduire son exposition aux polluants émis par le meuble."