









Thank you for purchasing this product. Please take time to read and follow the instructions below. Check that you have all parts and hardware before assemble. Parts apparently missing are often found in the paking materials. If you do not have all the parts listed, have your dealer contact us and they will be sent to you immediately.

Merci d'avoir acheté ce produit de qualité. Vérifiez avant le montage que vous avez toutes les pièces et fixations. Les pièces qui semblent manquer se trouvent souvent dans les matériaux d'emballage. Si vous n'avez pas toutes les pièces de la liste, demandez à votre détaillant et nous vous les enverrons immédiatement.

HARDWARE LIST /LISTE DE QUINCAILLERIE				PART LIST /LISTE DE PIECES			
1		Short Bolt / Petit Boulon	Ø1/4" x L40 mm	2	A	Chair back	1
2		Medium Bolt / Moyen Boulon	Ø1/4" x L60 mm	4	B	Cushion Seat	1
3		Long Bolt / Grand Boulon	Ø1/4" x L75 mm	4	C	RSF Leg	1
4		Lock Washer / Rondelle D'arret	Ø5/16"	10	D	LSF Leg	1
5		Flat Washer / Rondelle Plate	Ø5/16" x 19 mm	10	E	RSF Stretcher	1
6		Wood Screw / Vis	Ø1/8" x 38 mm	6	F	LSF Stretcher	1
7		Allen key / Cle Allen	4*59 mm	1	G	Front Stretcher	1
8		Screw Driver (not provided)					

STEP 1 / ETAPE 1

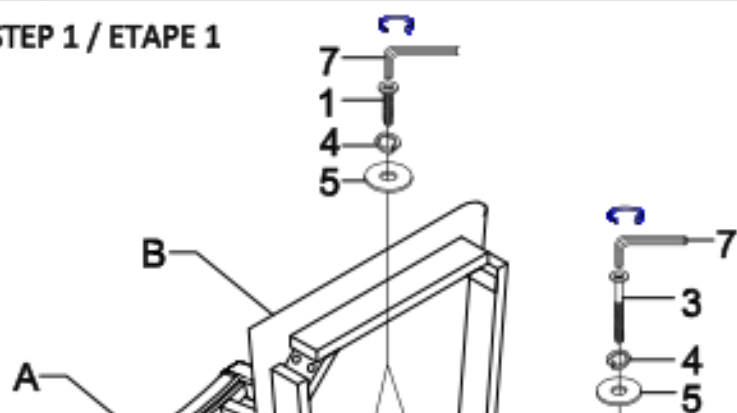

STEP 2 / ETAPE 2

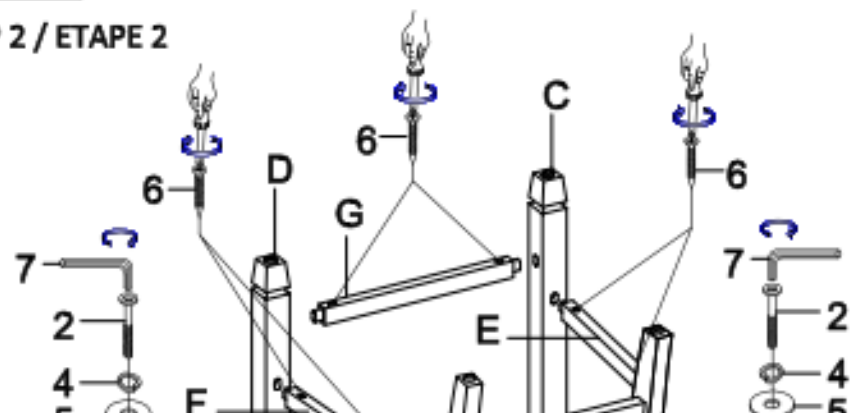

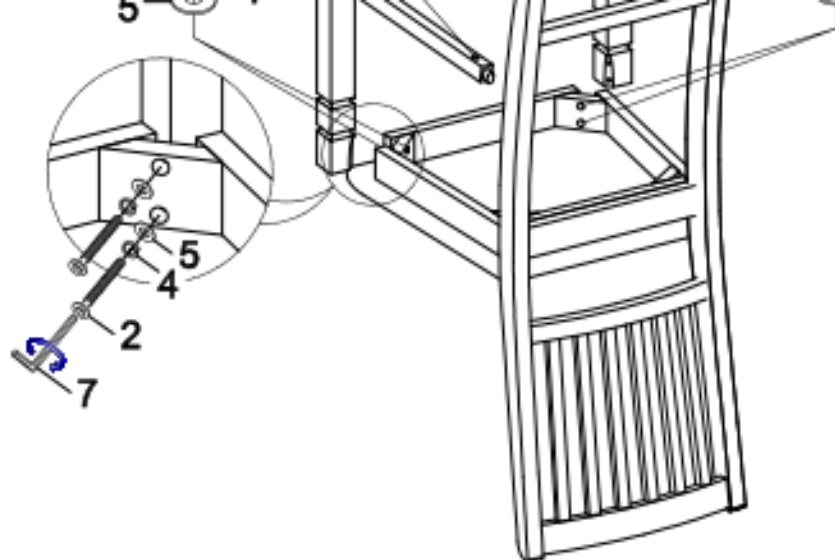
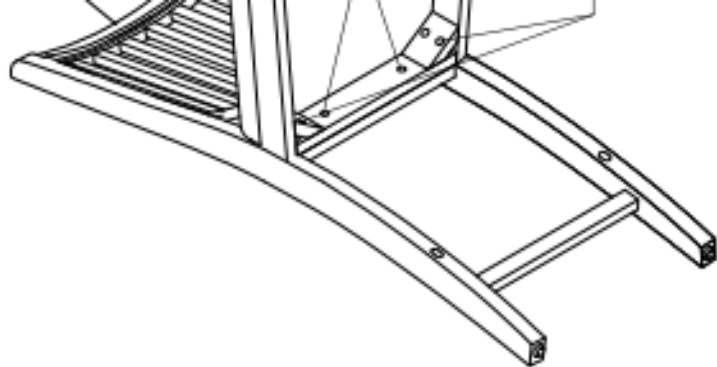

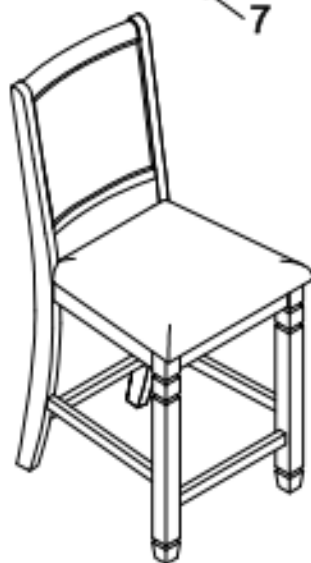

STEP 3 / ETAPE 3



Completed Assembly /
Assemblee Completee

-  It is recommended to install protective pads under all legs and supports to avoid damage or scratches when placing furniture on a wood floor or other hard surface, and to limit indentation and prevent discoloration if placing on carpet.
-  Il est recommandé de placer des coussins protecteurs sous tous les pieds et toutes les bases des meubles pour éviter d'endommager ou d'égratigner les planchers en bois ou autres surfaces dures, et pour limiter l'empreinte et empêcher la décoloration quand les meubles reposent sur la moquette.