

# Assembly Instruction

Accent Cabinet

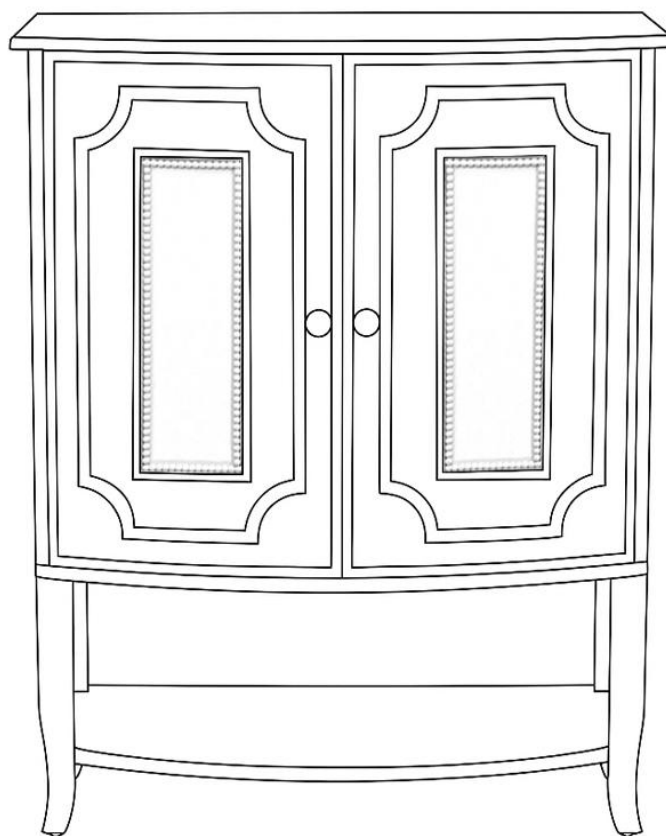













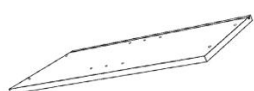

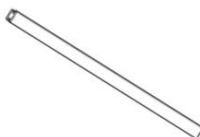

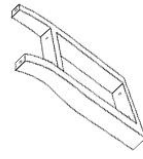
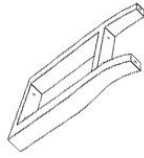
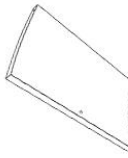
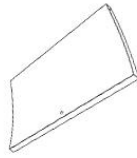
**⚠ WARNING:**

- Read all instructions carefully and completely before assembly and use.
- Retain for future reference.
- **DO NOT use power tools.**
- **DO NOT over-tighten hardware.**
- Periodically check all hardware and re-tighten as necessary.
- DO NOT use product if any component becomes damaged.
- For residential (non-commercial) use only.
- DO NOT sit or stand on product. Use only for intended purpose.
- DO NOT exceed 80lbs for the tabletop and 30lbs for the shelf, evenly distributed.

If you encounter any issues during installation or use, please email us at [support@mi-din.com](mailto:support@mi-din.com), including your order ID and a detailed description of the problem. If possible, please provide relevant images to expedite assistance. We will strive to resolve any issues promptly.

**Parts List**

Check all parts before assembly

<p>A. <u>Tabletop</u></p>  <p style="text-align: right;">*1</p>	<p>B. <u>Side panel</u></p>  <p style="text-align: right;">*1</p>	<p>C. <u>Side panel</u></p>  <p style="text-align: right;">*1</p>	<p>D. <u>Back panel</u></p>  <p style="text-align: right;">*2</p>
<p>E. <u>Back strip</u></p>  <p style="text-align: right;">*1</p>	<p>F. <u>Bottom panel</u></p>  <p style="text-align: right;">*1</p>	<p>G. <u>Bottom Shelf</u></p>  <p style="text-align: right;">*1</p>	<p>H. <u>Leg</u></p>  <p style="text-align: right;">*1</p>
<p>I. <u>Leg</u></p>  <p style="text-align: right;">*1</p>	<p>J. <u>Door</u></p>  <p style="text-align: right;">*1</p>	<p>K. <u>Door</u></p>  <p style="text-align: right;">*1</p>	<p>L. <u>Shelf (Inside)</u></p>  <p style="text-align: right;">*1</p>
<p>H1. <u>Hex bolt</u></p>  <p style="text-align: right;">*16(+1 extra)</p>	<p>H2. <u>Washer</u></p>  <p style="text-align: right;">*16(+1 extra)</p>	<p>H3. <u>Foot pad</u></p>  <p style="text-align: right;">*4</p>	<p>H4. <u>Alley key</u></p>  <p style="text-align: right;">*1</p>
<p>H5. <u>Shelf pin</u></p>  <p style="text-align: right;">*4</p>	<p>H6. <u>Knob</u></p>  <p style="text-align: right;">*2</p>	<p>H7. <u>Screw</u></p>  <p style="text-align: right;">*2</p>	<p>H8. <u>Door hinge</u></p>  <p style="text-align: right;">*4</p>

Step 1: Put the Tabletop (A) on a soft surface to protect the finish.

Attach Side panel (B&C) to the Top (A) with Hex bolts (H1) and Washers (H2) using Allen key (H4).

Ensure the Side panel (B&C) aligned the groove on Top(A).

**Leave hardware loose in this step.**

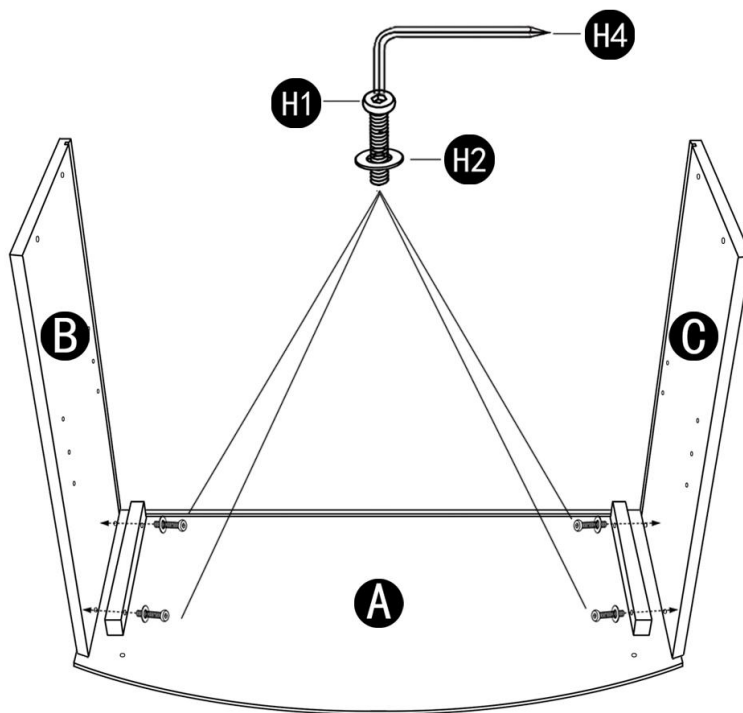

Step 2: Insert the Back panels (D)&Back strip (E) as shown below. Ensure the Back panels (D) aligned Groove on the Side panel (B&C)

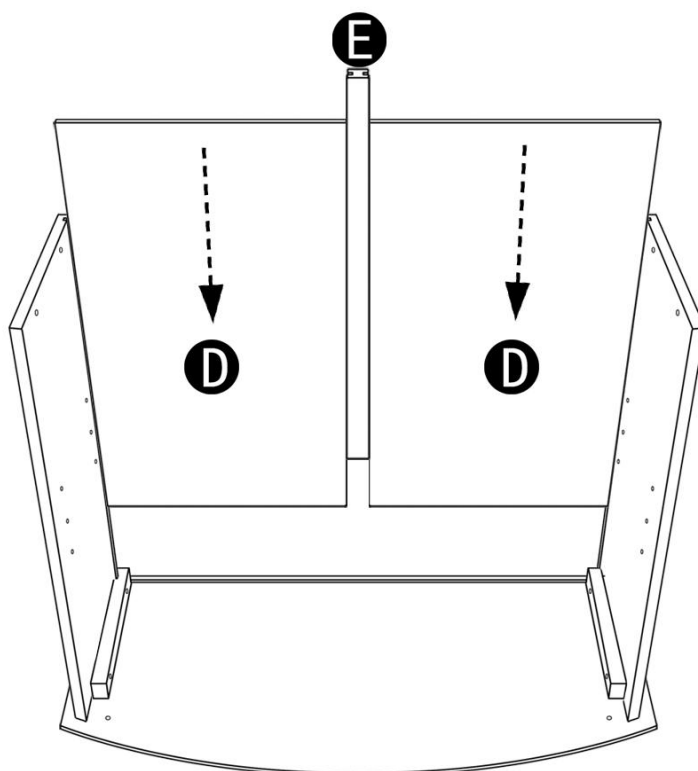

Step 3: Attach the Bottom panel (F) to the main body with Hex bolts (H1) and Washers (H2) using Allen key (H4) as shown in picture below. **Fully tighten all bolts from Step 1 to 3.**

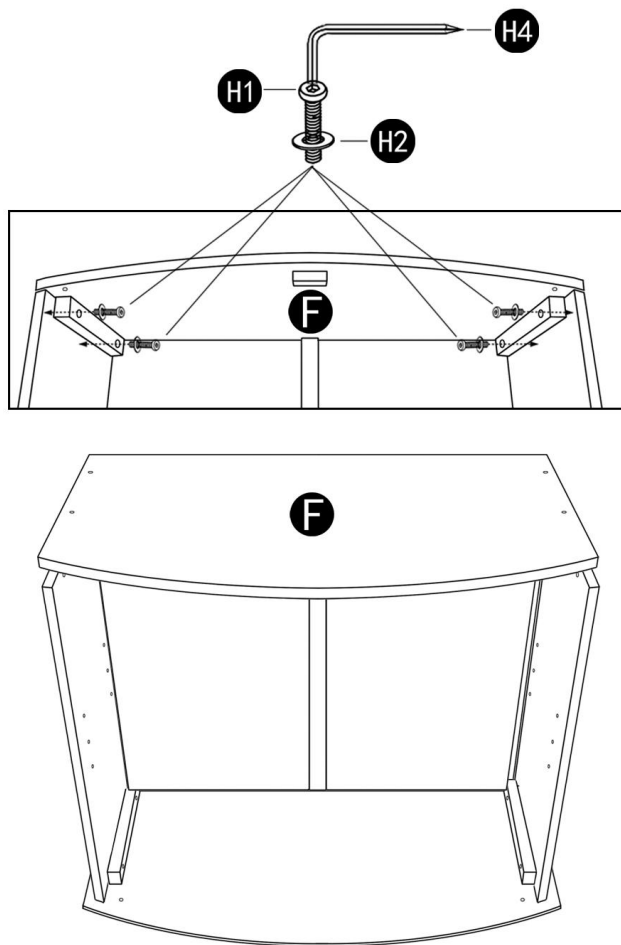

Step 4: Attach the Bottom Shelf (G) to Legs (H&I) with Hex bolts (H1) and Washers (H2) by Allen key (H4). Then, Attach it to main Body with Hex bolts (H1) and Washers (H2) by Allen key (H4). Attach the Foot pad (H3) to the bottom of the legs.

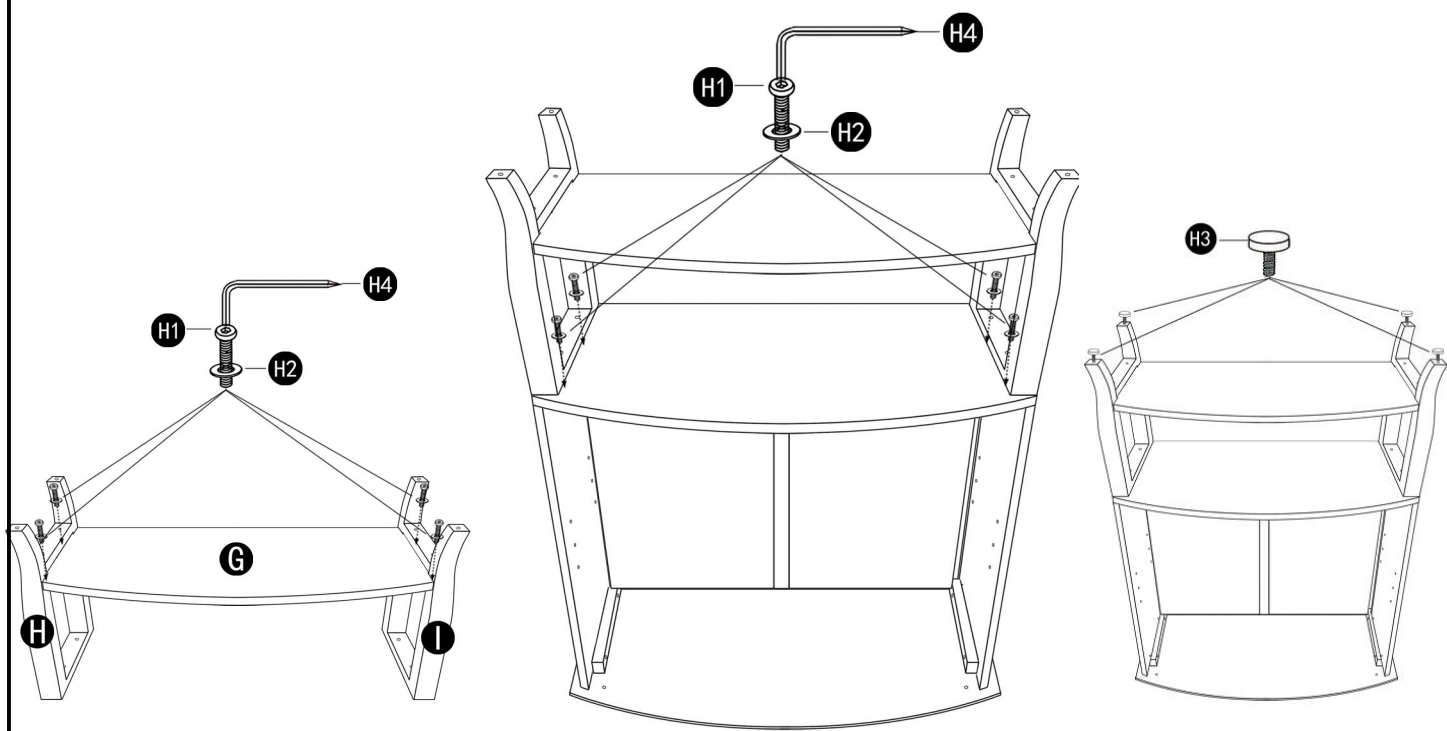

Step 5: Insert the Shelf pins (H5) into the holes. Place the Shelf (L) inside as shown in picture below.  
(Each side panel with 6 adjustable holes.)

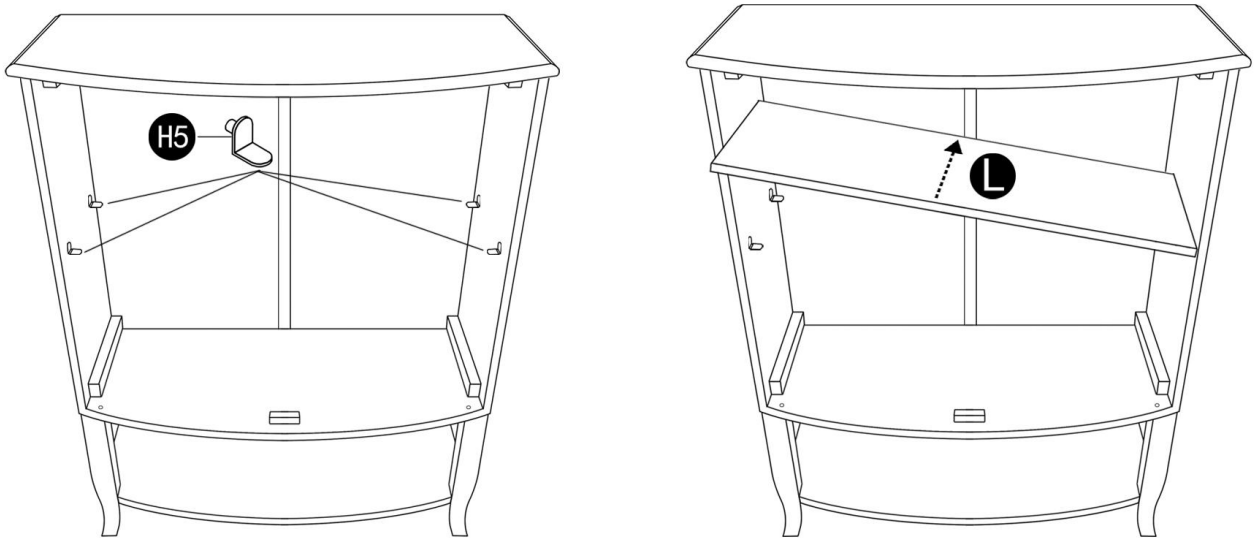

Step 6: Attach the door knob (H6) to each door using screw (H7) and tighten with (H4).  
Insert the bottom door pin (H8) and top door pin (H8) into the corresponding holes on the doors.  
Insert the **bottom** door pin (H8) into the hole on the cabinet first, then press down the top door pin (H8) to secure the door in place.

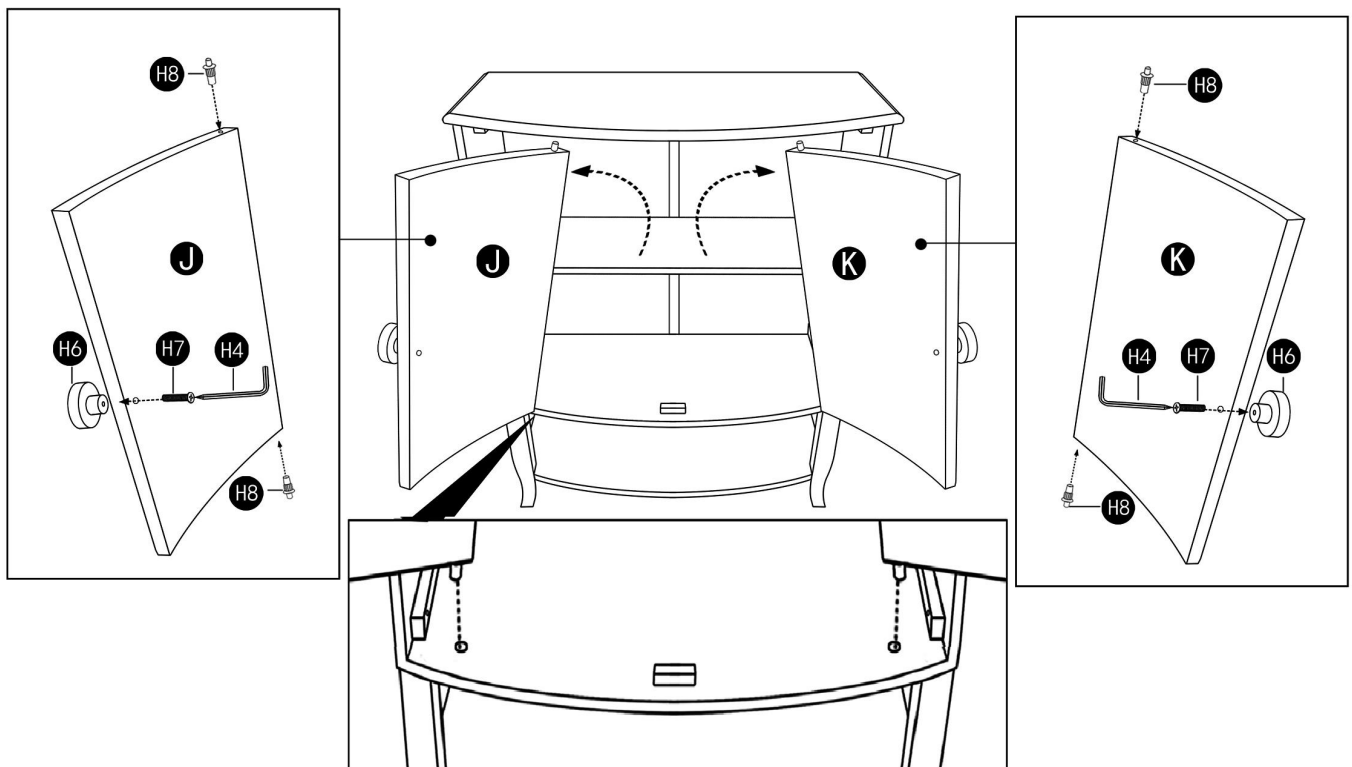

Assembly finished.