

Congratulation on your purchase.

Questions and concerns about your our product ?

You can contact us, we are happy to serve you to
your satisfaction!



BOOKSHELF & BOOKCASE

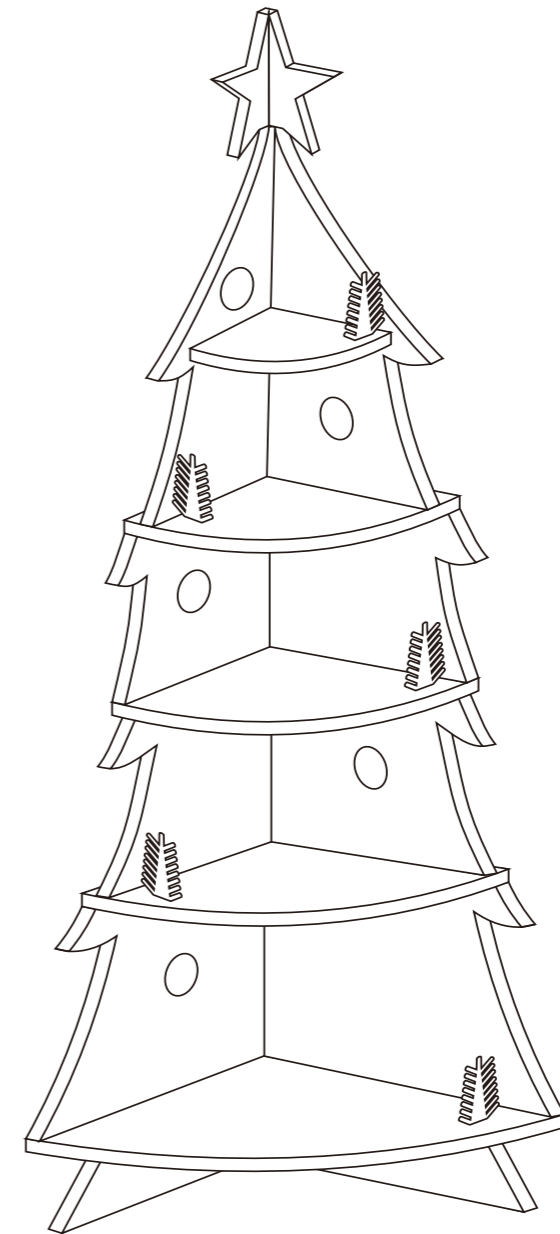

INSTRUCTION MANUAL

Before you begin

1. Check for damaged or missing parts
2. Gather all tools prior to assembly.
3. Use the assembly, surface to prevent product damage during assembly.
4. Do not over tighten.
5. During assembly, as this may damage the product. Do not use power tools.

Care Instruction

1. Wipe clean with damp cloth
2. Do not use strong detergents or abrasive cleaners, they may damage the surface
3. Check and tighten screws regularly
4. Do not stand on the product, do not use the product as a stepladder
5. Do not put anything hot on the surface.
6. Indoor use only.
7. Questions and concerns about your BALANBO product? Send email to alanbo@balanbo.com

Part List

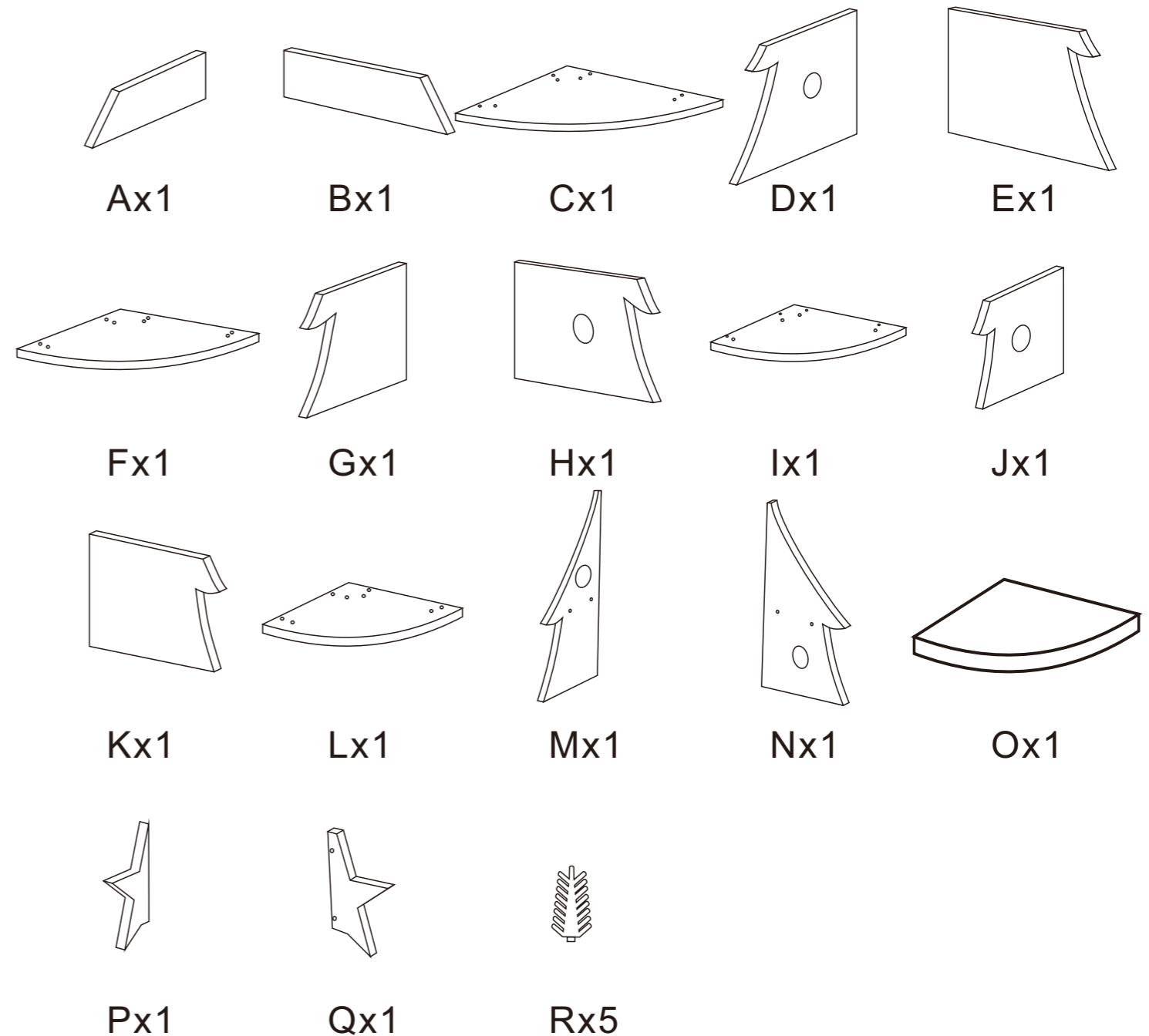

Hardware List

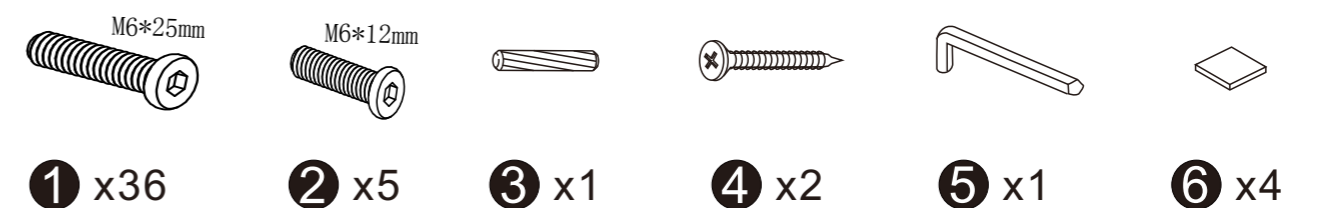

STEP1

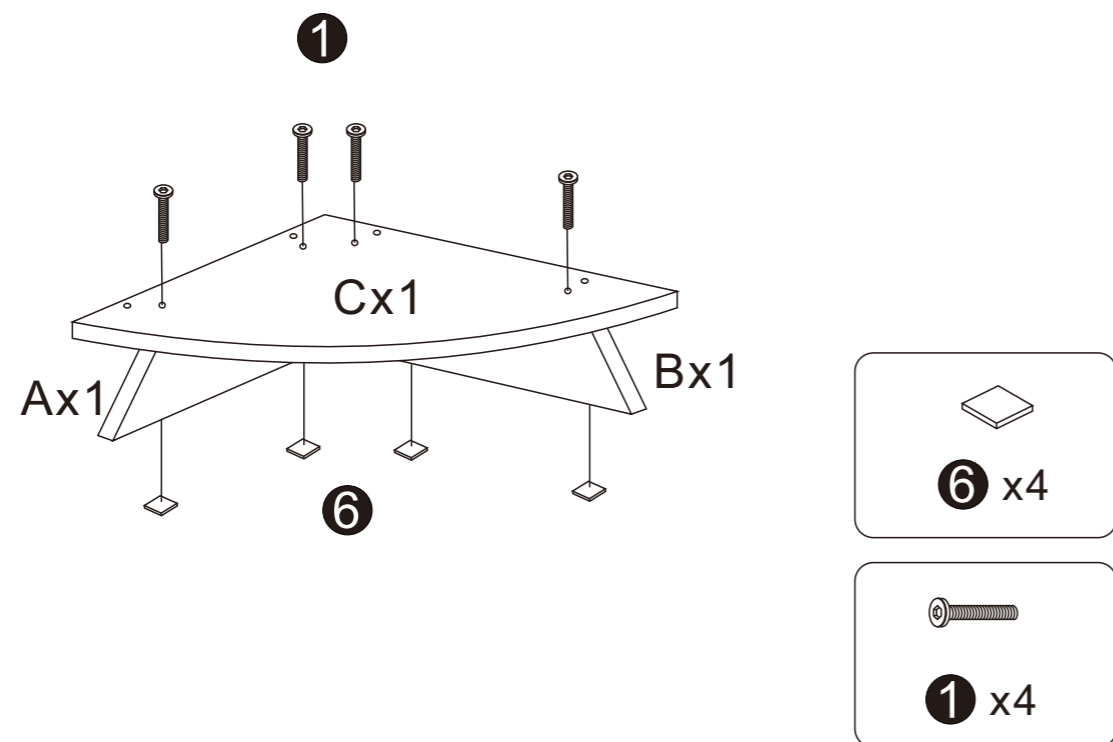

STEP2

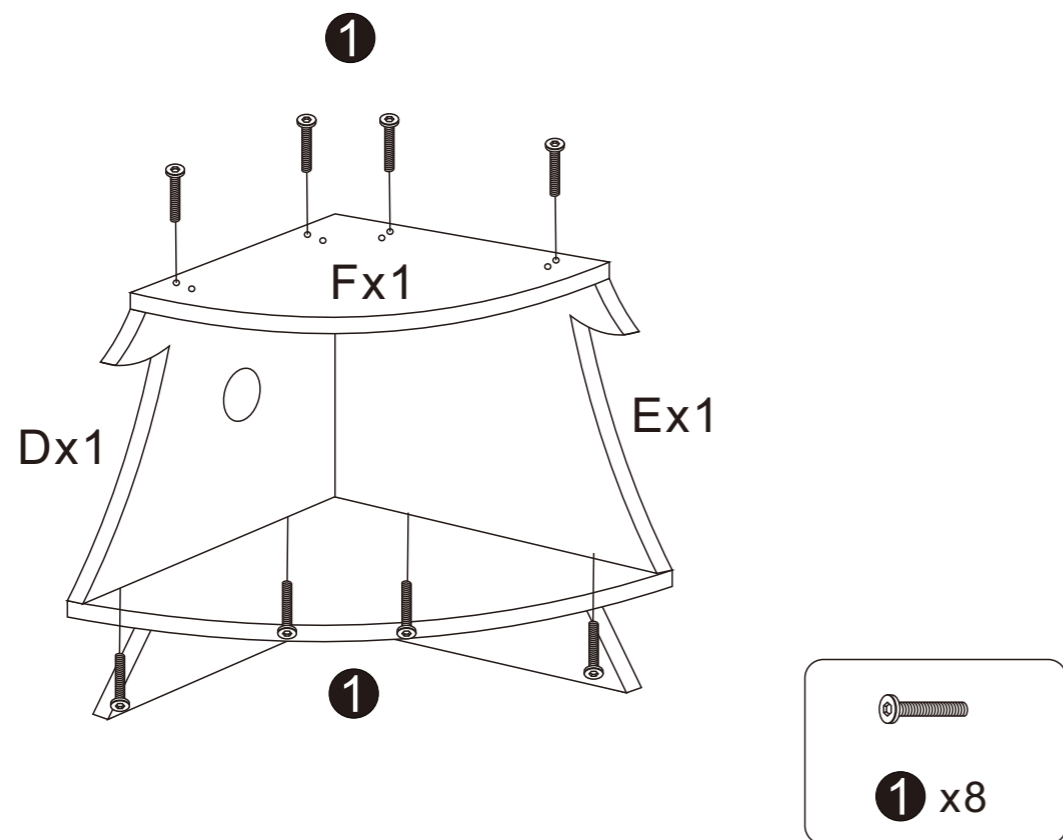

AFTER SALES SUPPORT

STEP3

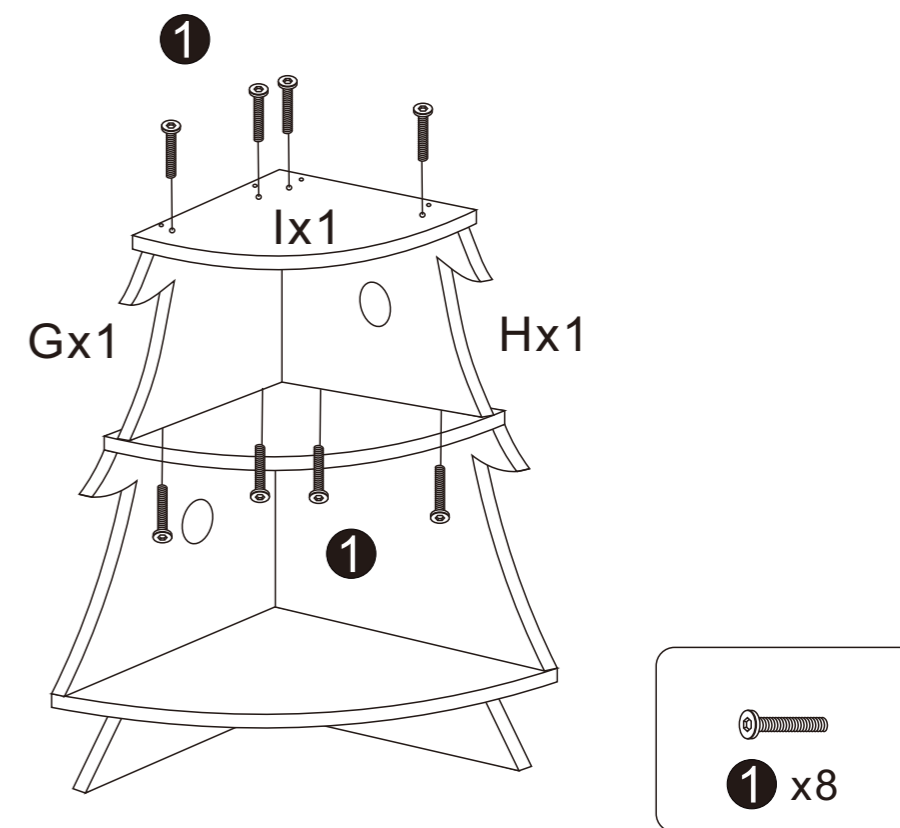

STEP4

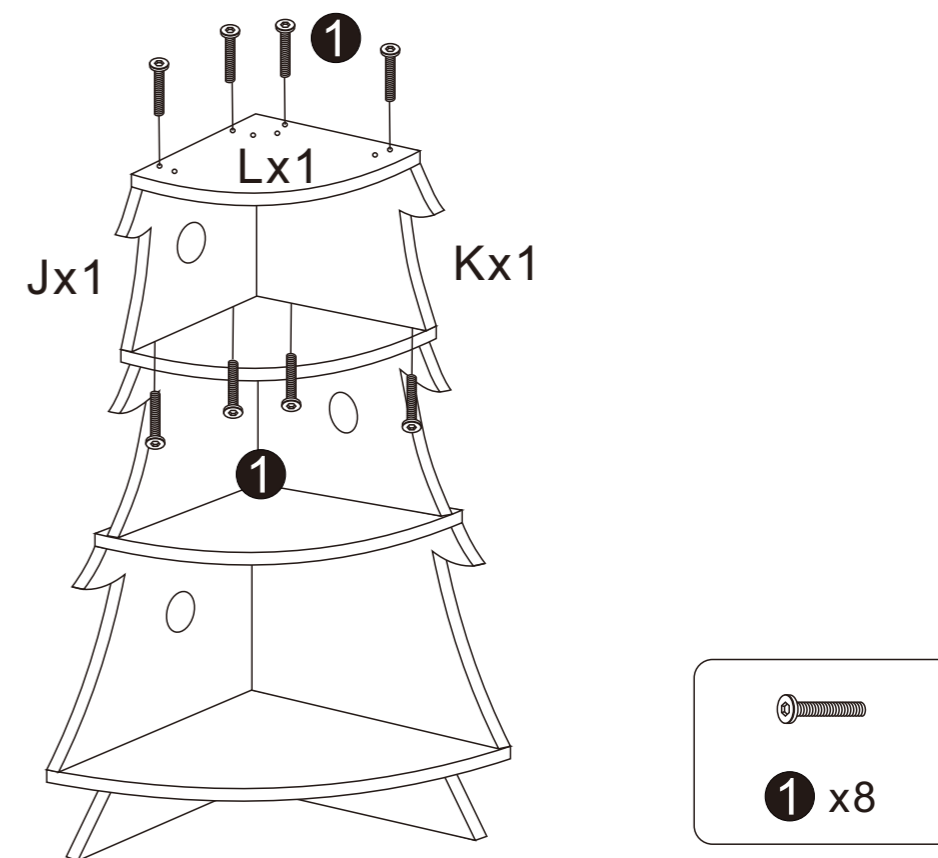

AFTER SALES SUPPORT

STEP5

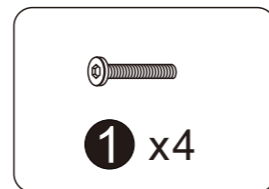
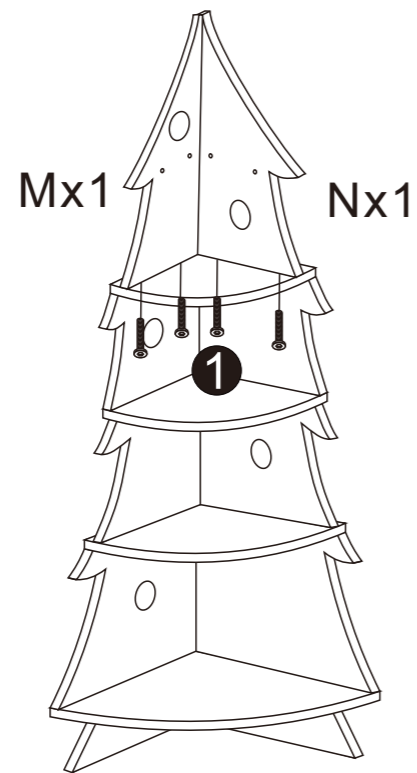

AFTER SALES SUPPORT

STEP7

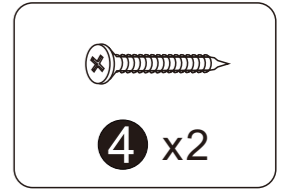
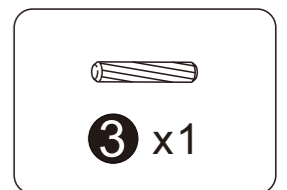
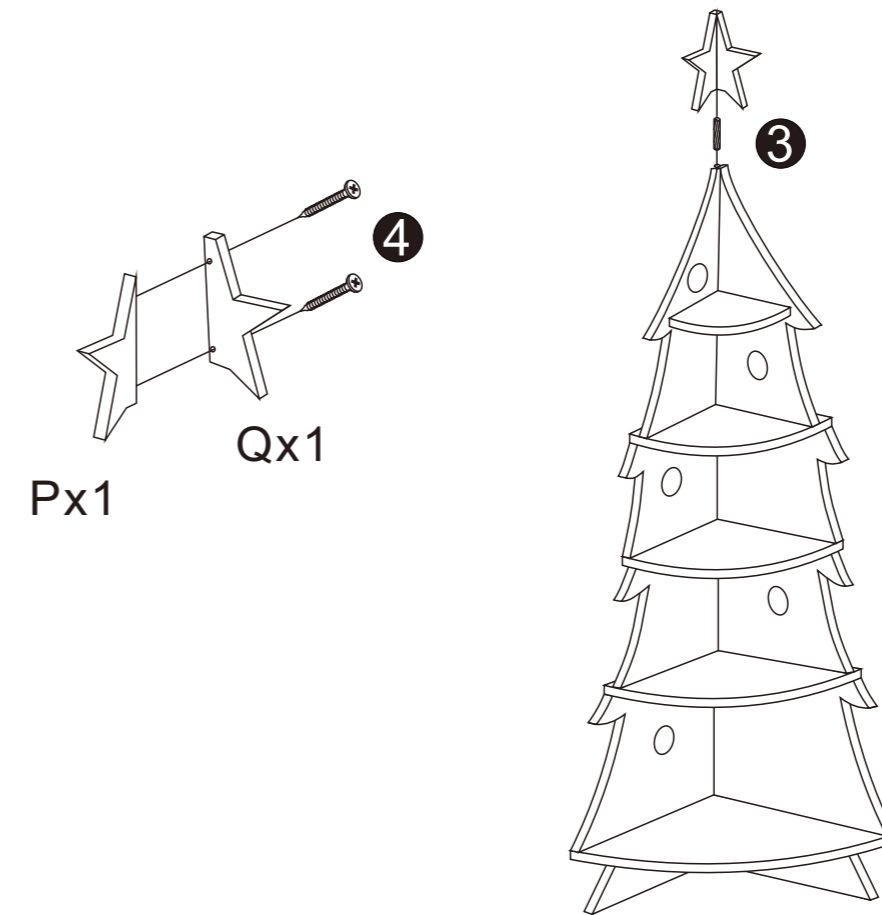

STEP8

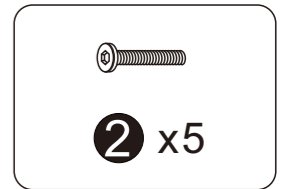
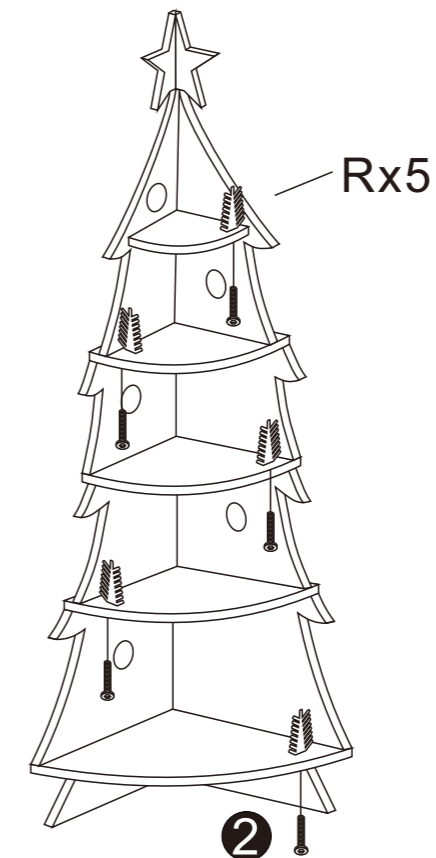
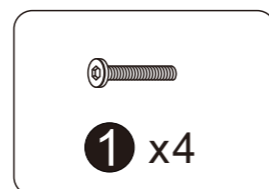
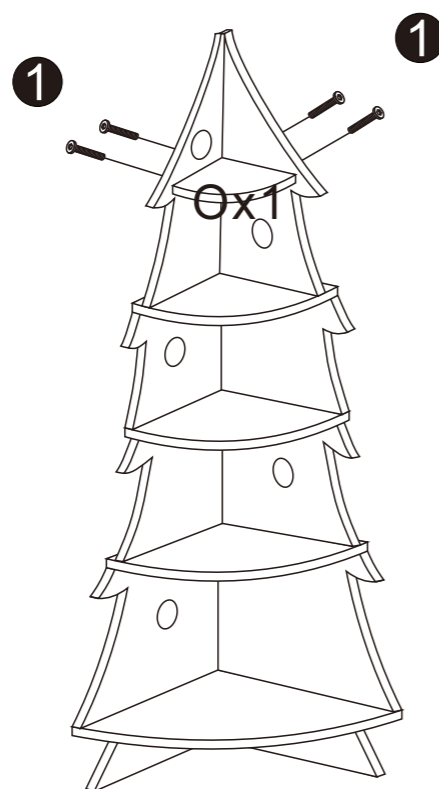

AFTER SALES SUPPORT