

Dining Table

**Notice:**

1. Follow the installation instructions. Please confirm all accessories are preset before installation.
2. Do not fully tighten the screws during initial assembly. Fully tighten screws only once all pieces which are correctly assembled.
3. If you encounter any problems during installation, please contact our customer service
4. Please unbox the item from the side with an open-label and put a carpet on the floor to avoid scratching it.



Recommended installers: 2



Put a carpet on the floor before unpacking

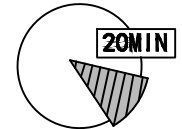





Estimate installation time: 20 minutes

Item no.	Reference Image	Qty
Ⓐ		x1
Ⓑ		x1

Item no.	Reference Image	Qty
①		x4
②		x1



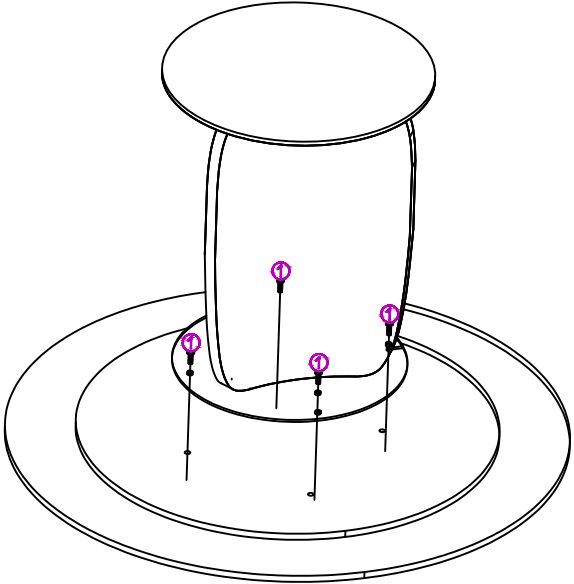

**1**

			
A 1pc	B 1pc	① 4pc	② 1pc



②

# Installation

Hardware List		Hardware List	
	1		4
	4		4
	1		

**1**



**2**

