









ASSEMBLY INSTRUCTION

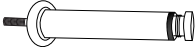

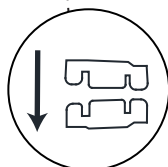
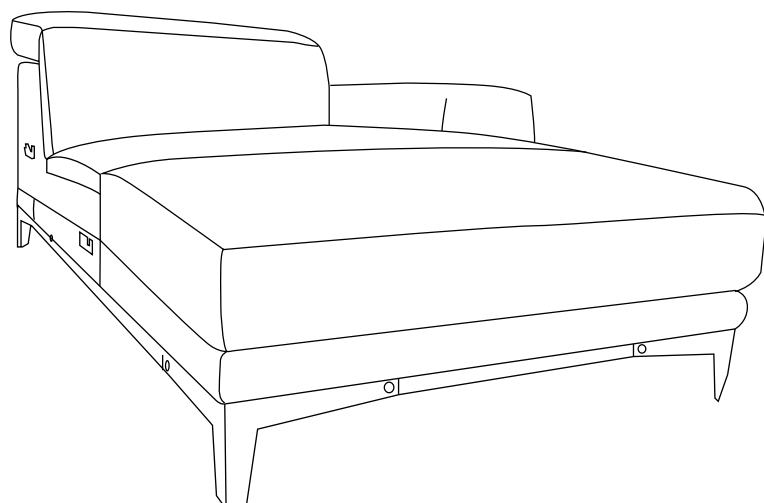
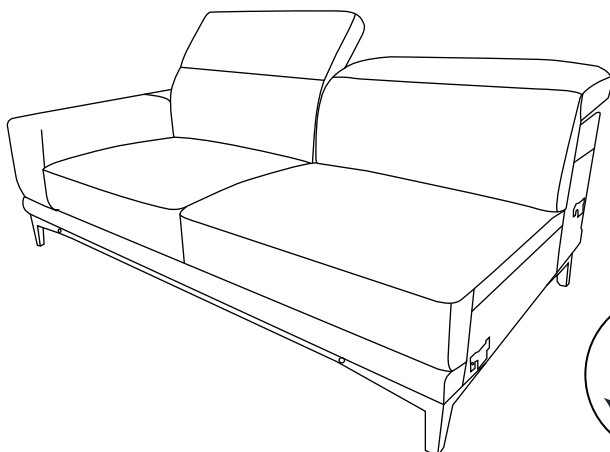
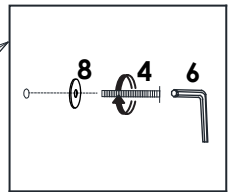
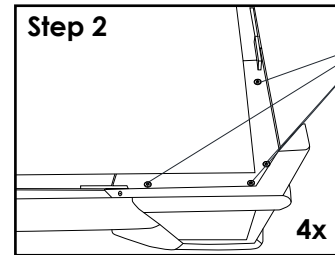
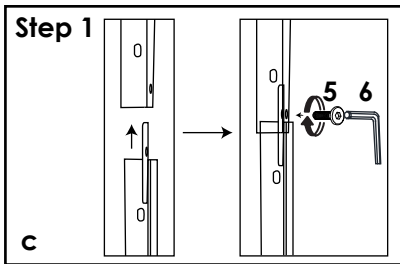
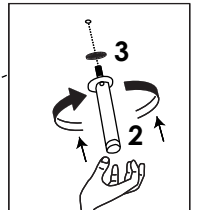
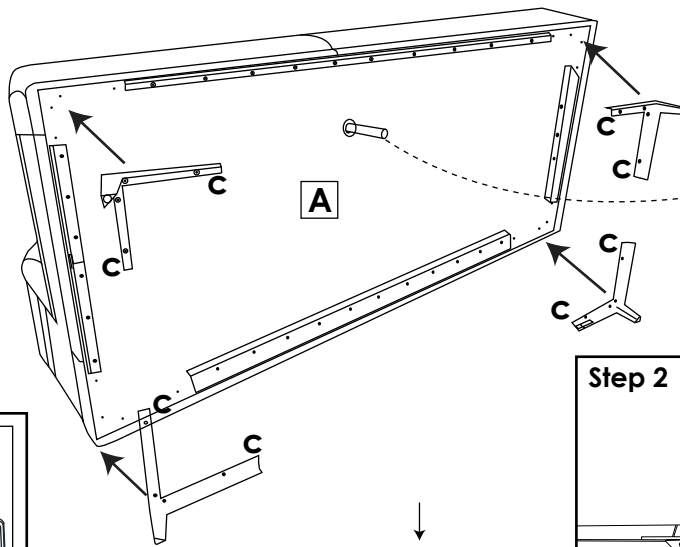
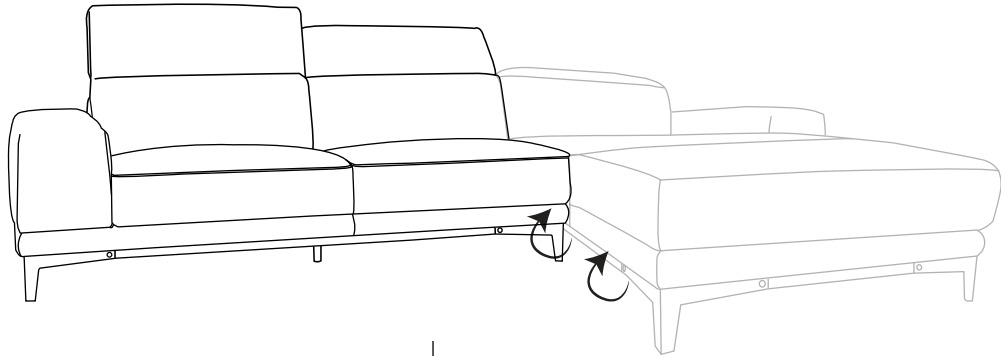

PART AND HARDWARE LIST

PART NO.	PART PHOTOGRAPH	PART NAME	QUANTITY	PART NO.	PART PHOTOGRAPH	PART NAME	QUANTITY
1		LEG	4	5		JCBC 24MM	8
2		SUPPORT LEG	1	6		M6 ALLEN KEY (for JCBC 35mm)	1
3		SUPPORT LEG WASHER	1	7		M8 ALLEN KEY (for JCBC 24mm)	1
4		JCBC 35MM	16	8		FLAT WASHER	16

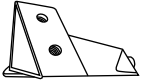

ASSEMBLY INSTRUCTION

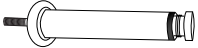
PART AND HARDWARE LIST

PART NO.	PART PHOTOGRAPH	PART NAME	QUANTITY	PART NO.	PART PHOTOGRAPH	PART NAME	QUANTITY
1		LEG	4	4		M8 ALLEN KEY (for JCBC 24mm)	1
2		SUPPORT LEG	2	5		SUPPORT LEG WASHER	2
3		JCBC 24MM	8				

