

installation instructions

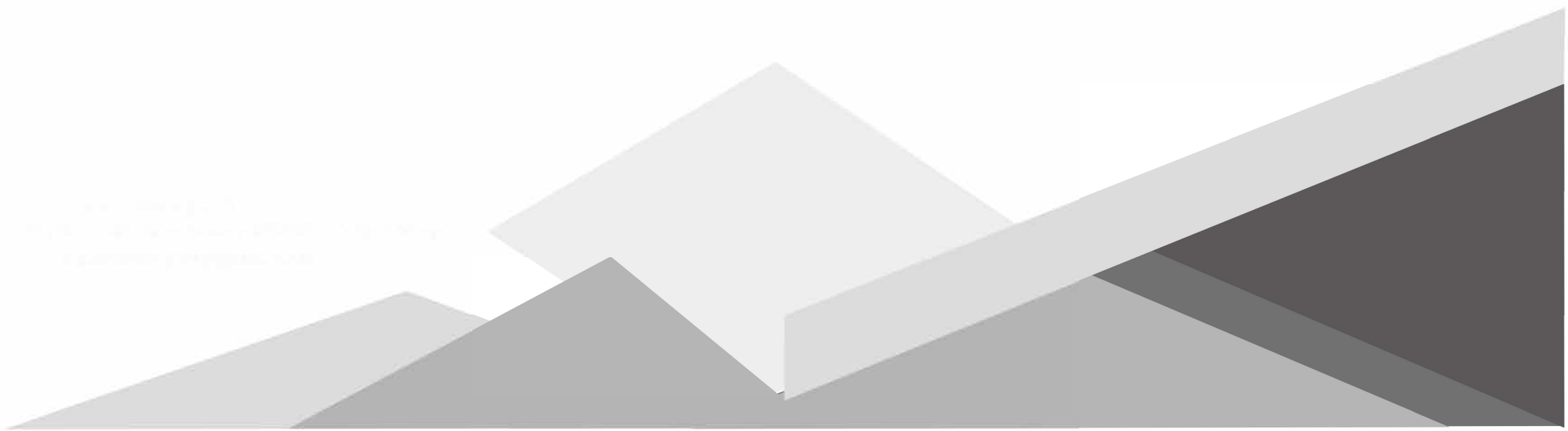
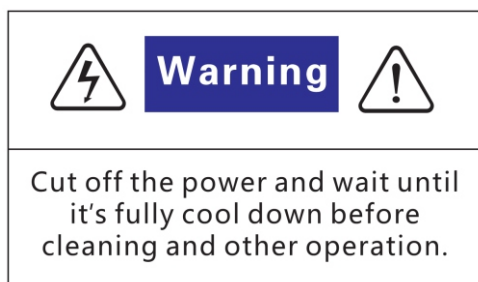

Table of Contents:

1. Safety Precautions-----	2
2. Product Feature Tips-----	3
3. Specifications and parameters-----	4
4. Environmental precautions-----	5
5. Appendix-----	6
6. Lamp installation-----	7/8
7. Maintenance and upkeep-----	9

Maintenance and upkeep

1. The power supply must be cut off before cleaning the lamps and maintenance, and the structure of the lamps and the parts of the lamps cannot be changed
2. Try not to switch frequently when using lamps, so that the instantaneous current of the lamp bead is greater than the current during normal operation, which greatly reduces its service life.
3. Wear gloves and wipe with a dry cloth feather duster and pay attention to prevent moisture intrusion, so as to avoid long-term corrosion damage or leakage and short circuit.
4. Special reminder that moisture can easily cause the lamps to rust and paint and shorten the service life of the lamps. Therefore, moisture-proof is the key to the maintenance of lamps. The lamps work normally for 2-3 hours a day, which can dehumidify the lamps and increase the indoor temperature, Dehumidification.



Safety Precautions

- Do not use the device if the power cord or other parts are damaged.
- The damaged power cord can only be repaired by product technical service personnel or qualified personnel, do not try to repair the lamp yourself.
- Do not expose the product to extreme temperatures, high humidity or strong mechanical force
- Keep lamps away from heat sources
- Wipe the lamp only with a soft dry cloth, do not use solvent-based or detergents otherwise the product may be damaged.
- Do not immerse the lamp in water, and do not expose the product to moisture or rain.

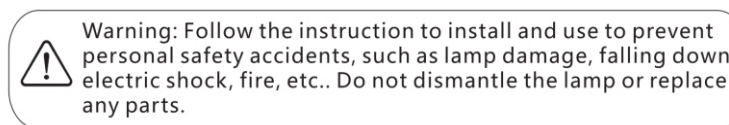

Product Feature Tips

1. The lamps are made of mirror stainless steel, which will not rust or corrode, and will last for a long time.
2. The crystal adopts the first-class K9 crystal in the market, the light refraction is dazzling, the brightness is high, and the light is soft and not dazzling.
3. Led light source has the advantages of long life, small size, low power consumption, multi-transformation, healthy use, high luminous efficiency, no noise, and stable performance.

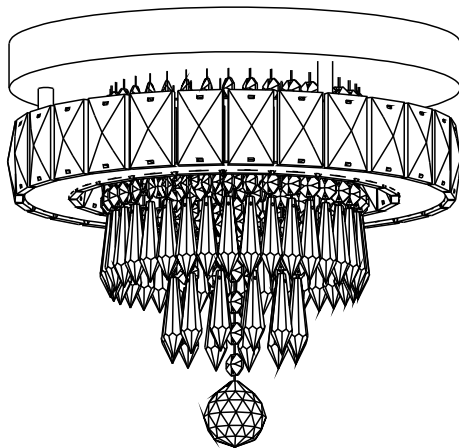

Accessories Installation Instructions

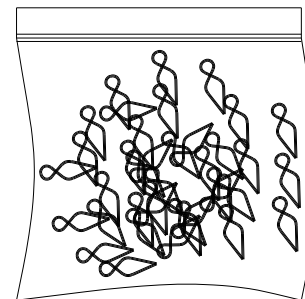

1. Remove the accessories

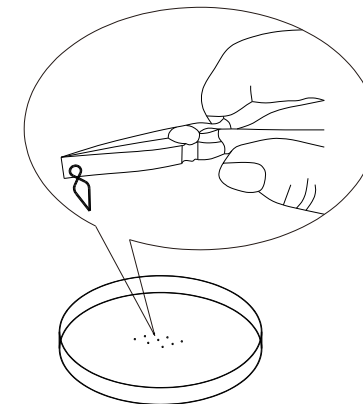

2. Hold it with tongs

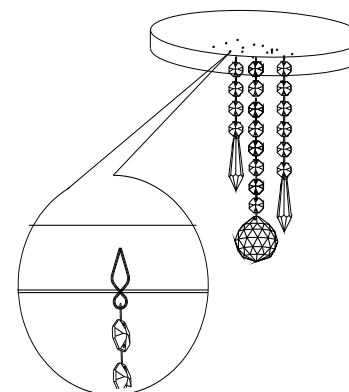

3. Force it into the hole

ITEM NO: 1339

NO	Crystal allocation plan	quantity	unit
A	14#Octagonai bead *4	30	pcs
B	14#Octagonai bead *6	15	pcs
C	14#Octagonai bead *6	1	pcs

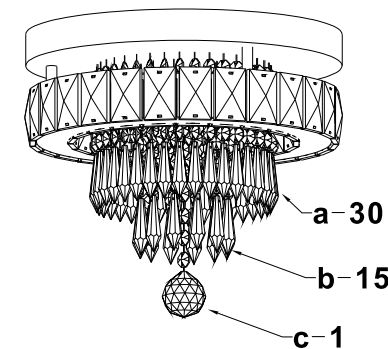

4. Hang crystal decorative balls

Lamp installation and operation instruction

1. Drilling
2. Fixed bracket
3. Fixed chassis

Note: wiring does not divide zero line and fire line
Please tear off the film before installation

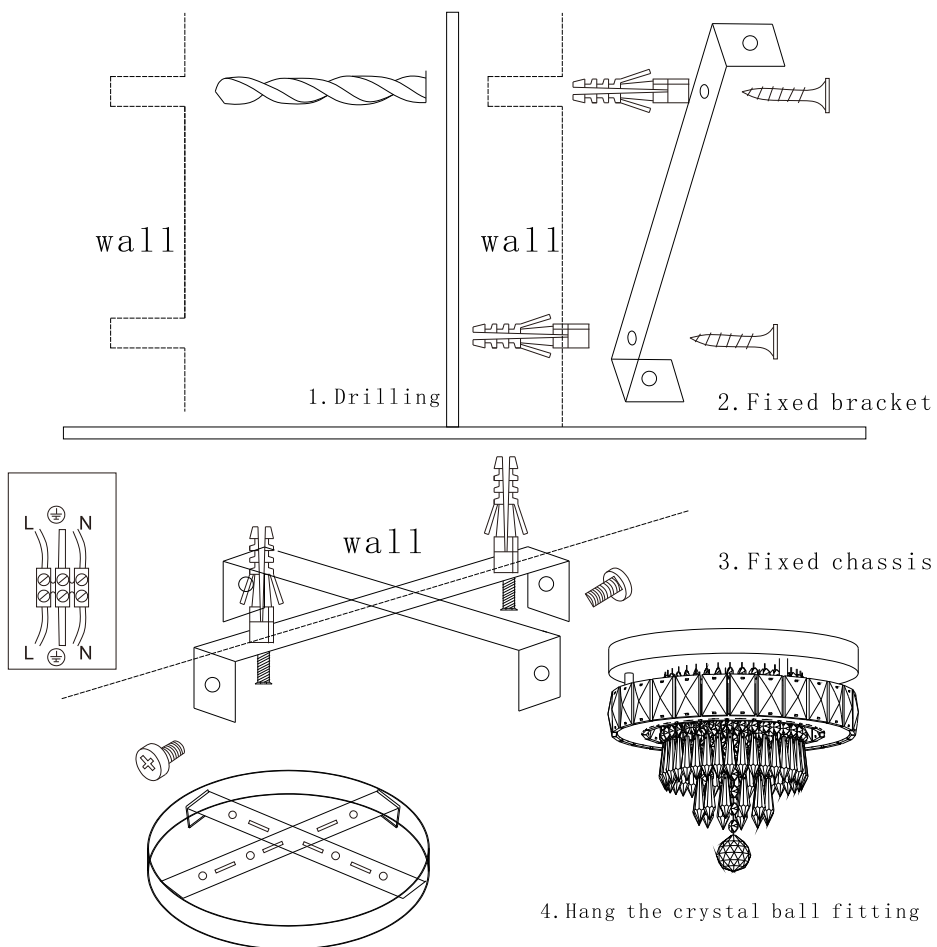

Dear customers, thank you for choosing our products. In order to ensure your safe and convenient installation and use of this product, please strictly in accordance with this manual operation

1. Suggest to ask professional electrician to install
2. Please tear the protective film before installing the lamp.
3. After turning on the light, do not touch the light source to avoid injury. Do not use this luminaire in the bathroom or in a humid environment

Specifications and parameters

Product name	Ceiling Lamp
Class	Class I
Model	LG1339
Power	27W
Color temperature	6000K
Power supply	85-265V 50/60HZ
Light source	LED
Size of the light	30x30x24cm

Environmental precautions



Information on Disposal for Users of WEEE

The wheelie bin symbol on the product (s) and/or accompanying documents means that used electrical and electronic equipment (WEEE) should not be mixed with general household waste.

For proper treatment, recovery and recycling, please take this product (s) to designated collection points where it will be accepted free of charge.

Alternatively, in some countries, you may be able to return your products to your local retailer upon purchase of an equivalent new product.

Disposing of this product correctly will help save valuable resources and prevent any potential negative effects on human health and the environment, which could otherwise arise from inappropriate waste handling.

Please contact your local authority for further details of your nearest designated collection point

Appendix

