

# ASSEMBLY INSTRUCTIONS

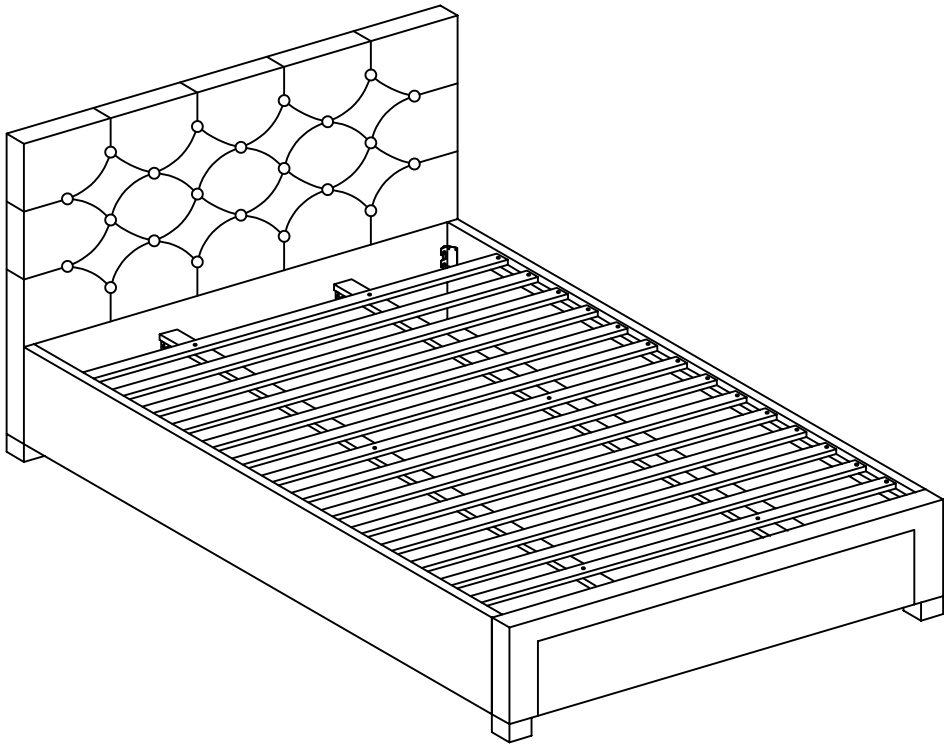

## TOOLS REQUIRED



Allen Wrench

(Included)

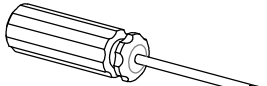

Phillips Screwdriver

(Not Included)



3 - People Recommended

## ASSEMBLY RATING



EASY —————> DIFFICULT

The Assembly Rating is a 5-point system showing the level of effort needed to assemble a specific product.



## **CHECK BEFORE STARTING**

### **Are you missing anything?**

Double-check all parts, hardware and accessories listed are all accounted for.

### **Check out our Quick Tips!**

We recommend reviewing the pre-assembly handouts. Even experts need a refresher now and then!

### **Should we send any replacements?**

Are there any irregularities or flaws in the parts? We can send replacements!

### **Prep Time!**

Please review the assembly instructions and all diagrams prior to assembling.

# PRE ASSEMBLY INTRODUCTION

We understand building ready-to-assemble furniture can be a challenging experience for some. To help avoid confusion, we have provided some helpful tips that may speed up the process.

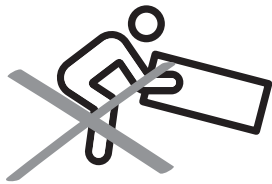

## Teamwork

ALWAYS have at least two people to help with transporting and assembling the product to avoid potential injury and/or damage.

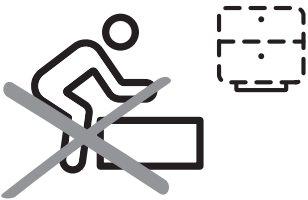

## Suitable Location

Assembling near the area of the intended location is highly recommended.



## Sufficient Space

Make sure you have enough space to move around during the assembly.



## Avoid Scratches

Use cardboard, blankets or a carpeted area while assembling furniture to prevent to prevent scratches and damages.



## Flat Surface

Make sure the furniture rests on a flat and level surface with each leg evenly touching the floor.

# ASSEMBLY AND CARE ADVICE



**FAILURE TO FOLLOW THE GUIDELINES BELOW MAY RESULT IN INJURY AND/OR PROPERTY DAMAGE.**



Position each part correctly and insert screws or bolts into their respective holes.

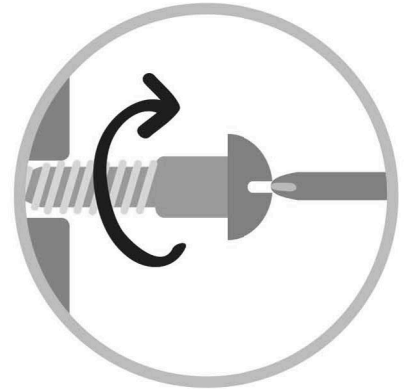

Turn clockwise to tighten and only tighten when step is completed or when instructed to do so.



Save the instructions and store any supplied tools for later maintenance.

Use the appropriate hand tools or power tools for assembly. Select steps, such as tightening screws and/or bolts, may require hand tools to avoid causing damage during assembly.



After two weeks, check and tighten any loose hardware and repeat again every six months thereafter.

**IT IS THE USER'S RESPONSIBILITY TO MAINTAIN THE FURNITURE. THE HARDWARE MAY LOOSEN OVER TIME AND MAY CAUSE THE FURNITURE TO BE WOBBLY AND UNABLE TO SUPPORT ITS INTENDED WEIGHT CAPACITY. THIS MAY LEAD TO COLLAPSE AND MAY CAUSE SERIOUS INJURY.**

# EASTERN / CALIFORNIA KING BED



- Please keep instructions for future reference.
- Check the quantity and irregularity of parts and hardware before you start.

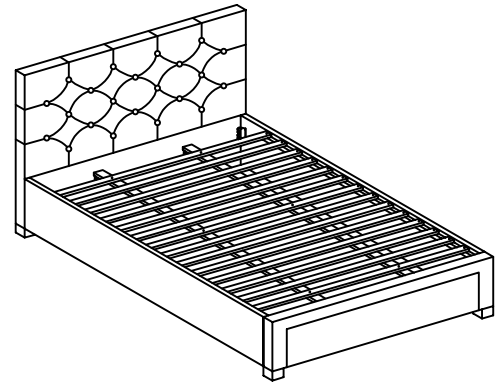

## PARTS

#1 x 1pc

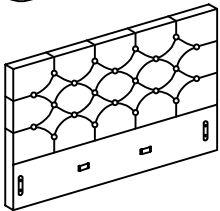

Headboard

#2 x 1pc

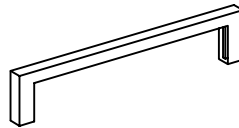

Footboard

#3 x 2pcs



Side Rail

#4 x 4pcs

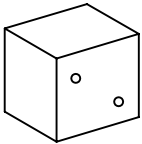

Legs

#5 x 2pcs



Center Rail  
EK - 2040mm  
CK - 2165mm

#6 x 4pcs



Bed Slat Support  
265x30x30mm

#7 x 14pcs



Bed Slat  
EK - 1947x45x18 mm  
CK - 1842x45x18 mm

#8 x 1pc

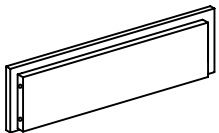

Drawer Front Panel

#9 x 1pc

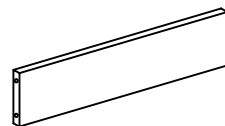

Drawer Back Panel

#10 x 2pcs

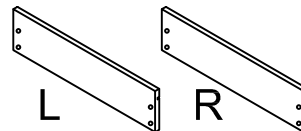

Drawer Side Panel

#11 x 1pc

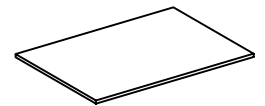

Drawer Bottom Panel

#12 x 3pcs

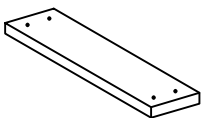

Drawer Bottom Panel Big Support

#13 x 2pcs

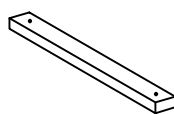

Drawer Bottom Panel Small Support

HARDWARE PACK IN FOOTBOARD

#A x 4pcs

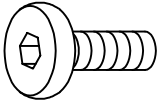

JCBC M6x40mm

#B x 1pc



Allen Wrench  
M4 x 65mm

#C x 1pc

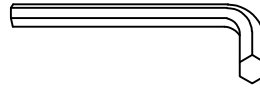

Allen Wrench  
M5 x 70mm

#D x 34pcs

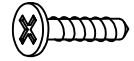

CSK Screw 32mm

#E x 8pcs

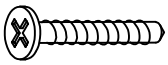

CSK Screw 50mm

#F x 4pcs

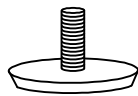

Adjuster

HARDWARE PACK IN DRAWER

#G x 24pcs

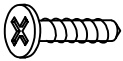

CSK Screw 16mm

#H x 16pcs

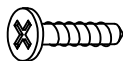

CSK Screw 32mm

#I x 8pcs

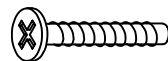

CSK Screw 50mm

#J x 6pcs



Roller

#K x 24pcs







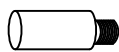



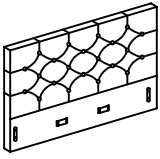
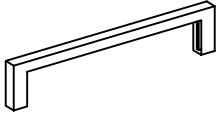

Power Nail 6/8

#L x 2pcs

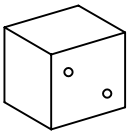



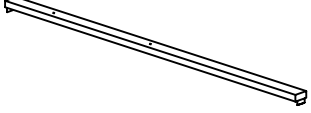



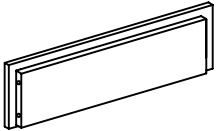
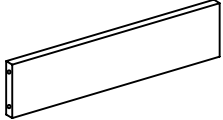
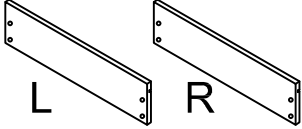

Metal Stopper

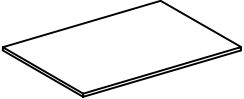
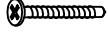
# POINT 4 CARTONS

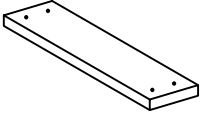
Carton	Designation	Part		Hardware
	Headboard	#1		
	Footboard	#2		
	Side Rail	#3		 #A x 4pcs  #B x 1pc  #C x 1pc
	Legs	#4		 #D x 34pcs  #E x 8pcs  #F x 4pcs
	Center Rail	#5		
	Bed Slat Support	#6		

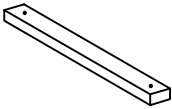
# POINT 4 CARTONS

Carton	Designation		Part	Hardware
	Drawer Front Panel	#8		
	Drawer Back Panel	#9		
	Drawer Side Panel	#10	 <p>L R</p>	 #G x 24pcs  #H x 16pcs
	Drawer Bottom Panel	#11		 #I x 8pcs  #J x 6pcs  #K x 24pcs
	Drawer Bottom Panel Big Support	#12		 #L x 2pcs
	Drawer Bottom Panel Small Support	#13		
	Bed Slat	#7		

# ASSEMBLY INSTRUCTIONS

1

- Part #1 x1pc
- Part #2 x1pc
- Part #4 x4pcs
- Hardware #E x8pcs

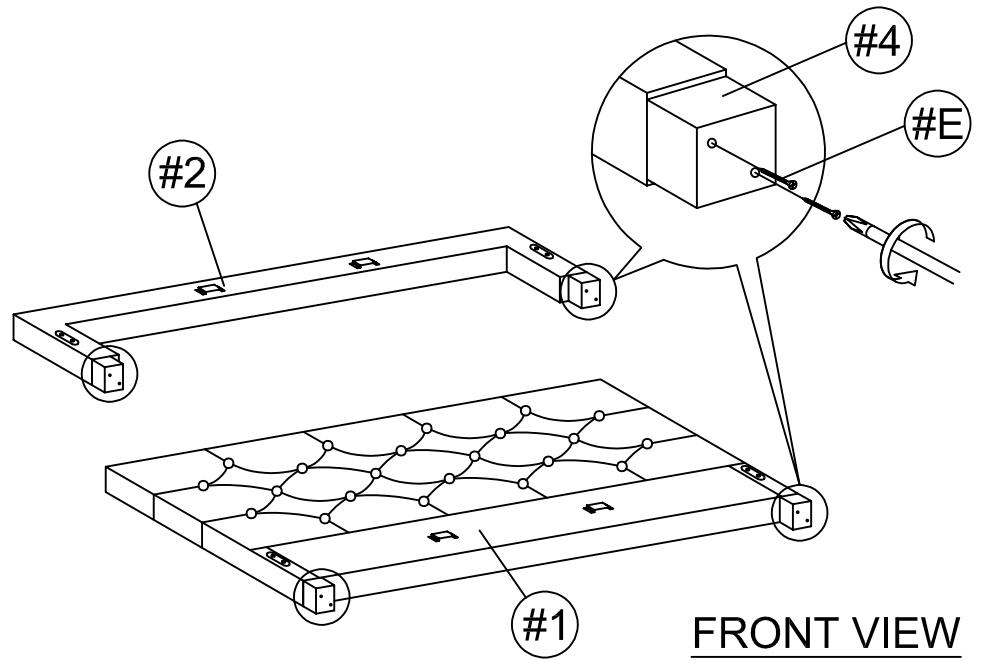

2

- Part #3 x2pcs

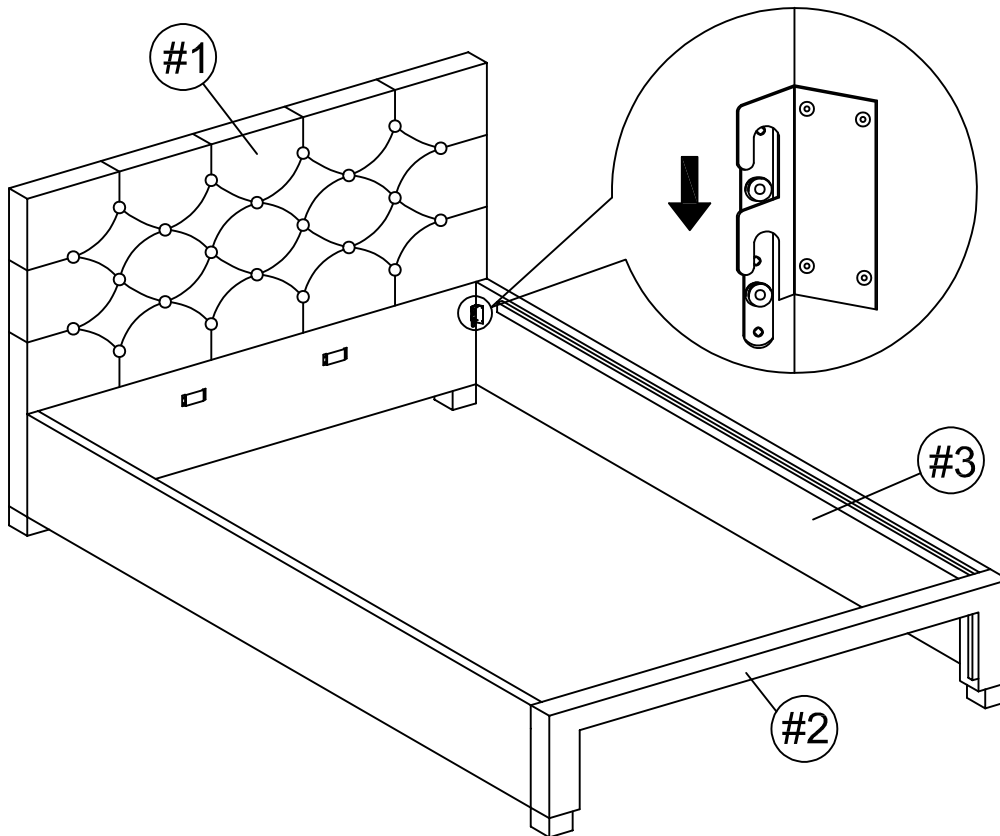

# ASSEMBLY INSTRUCTIONS

## 3

Part #5 x2pcs

Part #6 x4pcs

Hardware #A x4pcs

Hardware #B x1pc

Hardware #F x4pcs

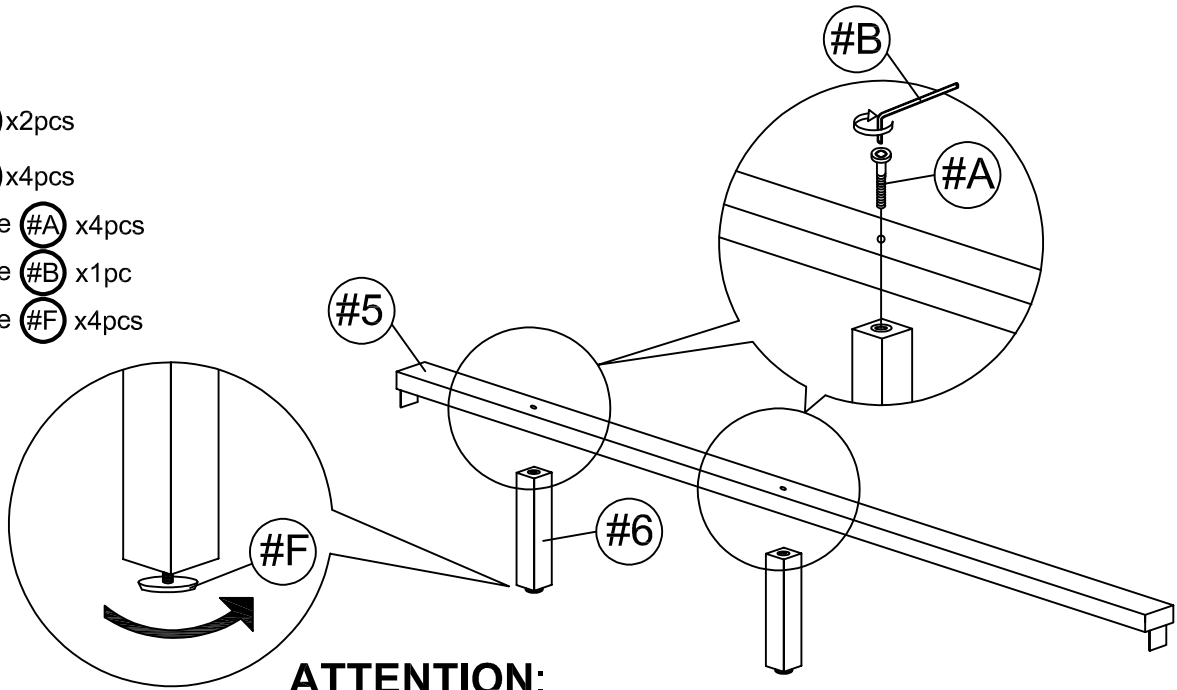

**ATTENTION:**

**Please keep the adjuster around 5 to 8 mm distant away from the floor.**

## 4

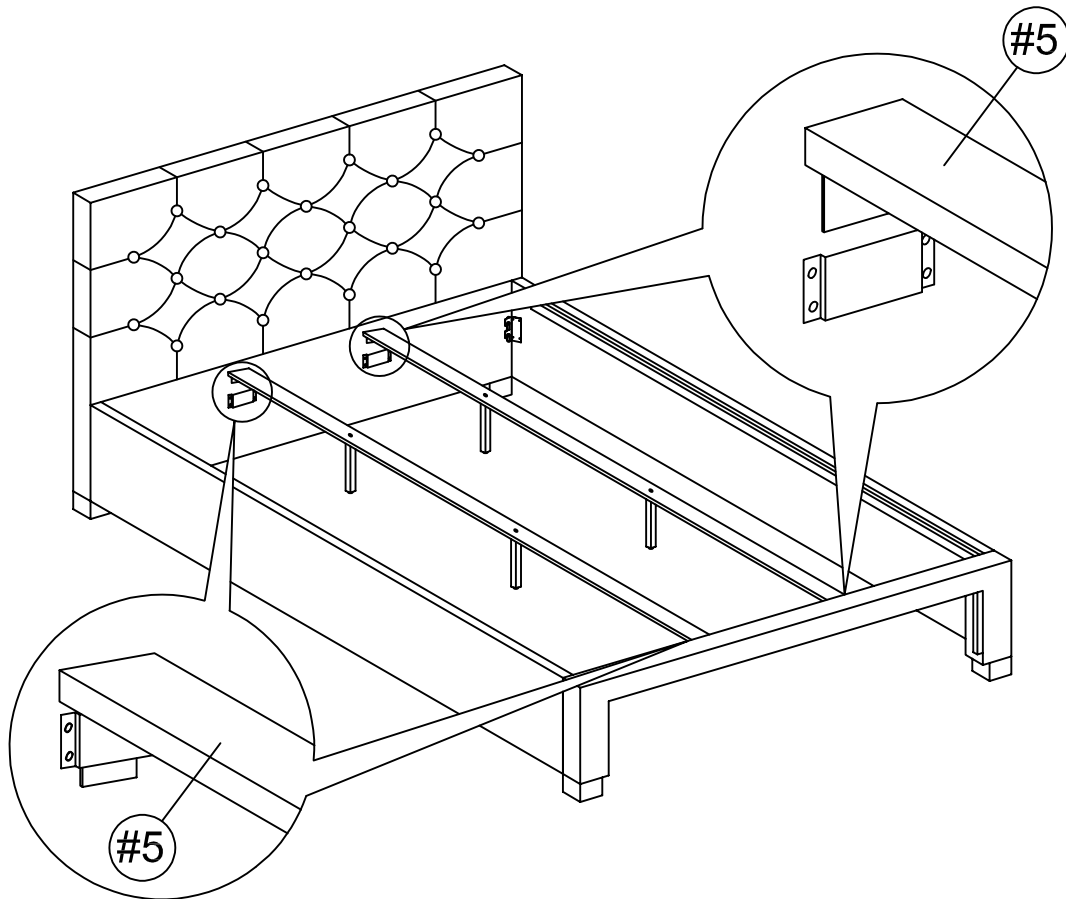

# ASSEMBLY INSTRUCTIONS

## 5

- Part #8 x1pc
- Part #9 x1pc
- Part #10 x2pcs
- Hardware #1 x8pcs

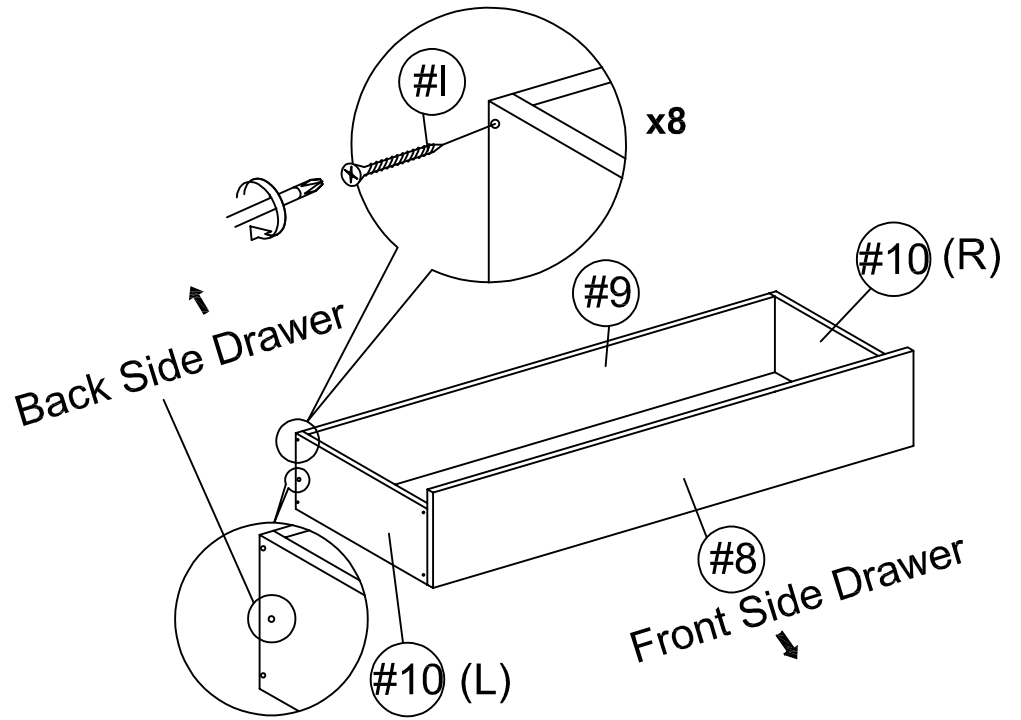

## 6

- Part #11 x1pc

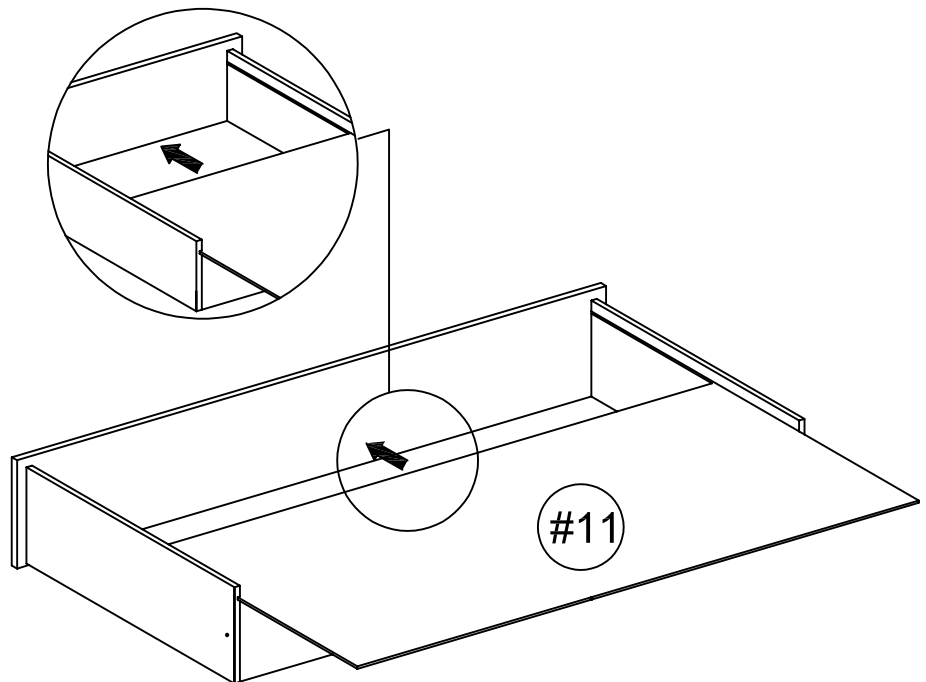

# ASSEMBLY INSTRUCTIONS

## 7

- Part #12 x3pcs
- Part #13 x2pcs
- Hardware #H x16pcs
- Hardware #K x24pcs

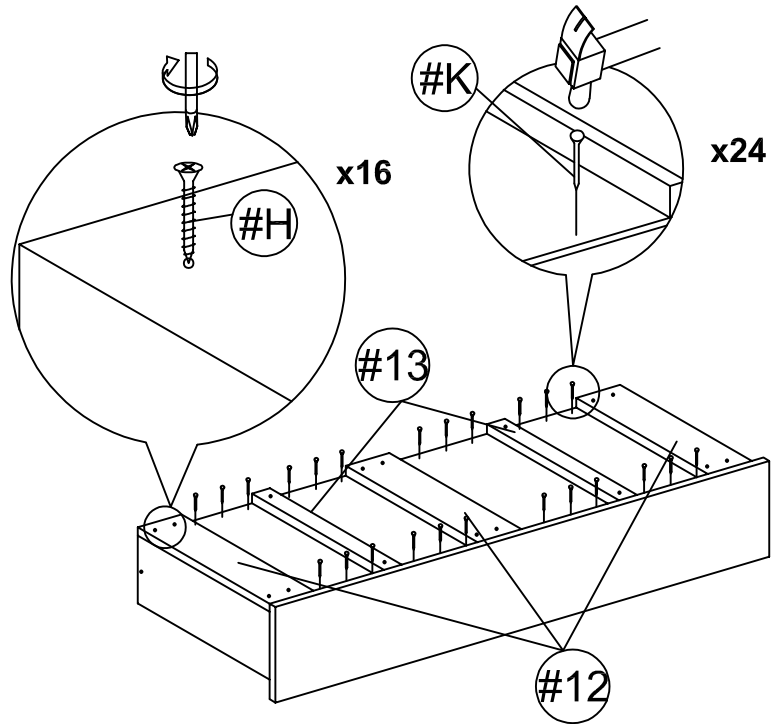

## 8

- Hardware #J x6pcs
- Hardware #G x24pcs

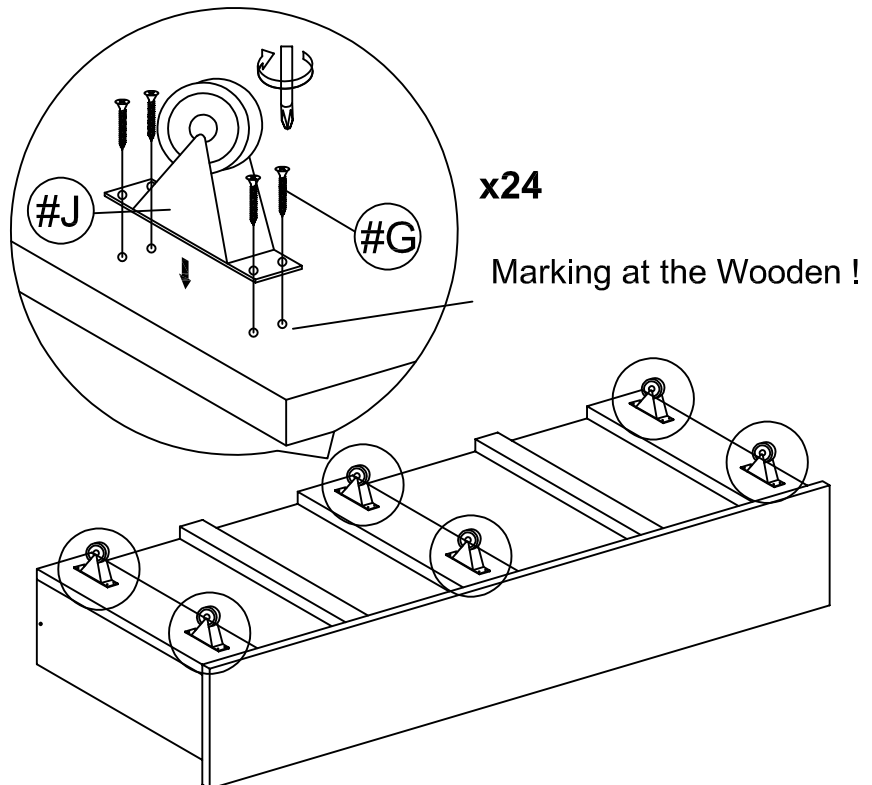

# ASSEMBLY INSTRUCTIONS

## 9

Part #7 x14pcs

Hardware #C x1pc

Hardware #D x34pcs

Hardware #L x2pcs

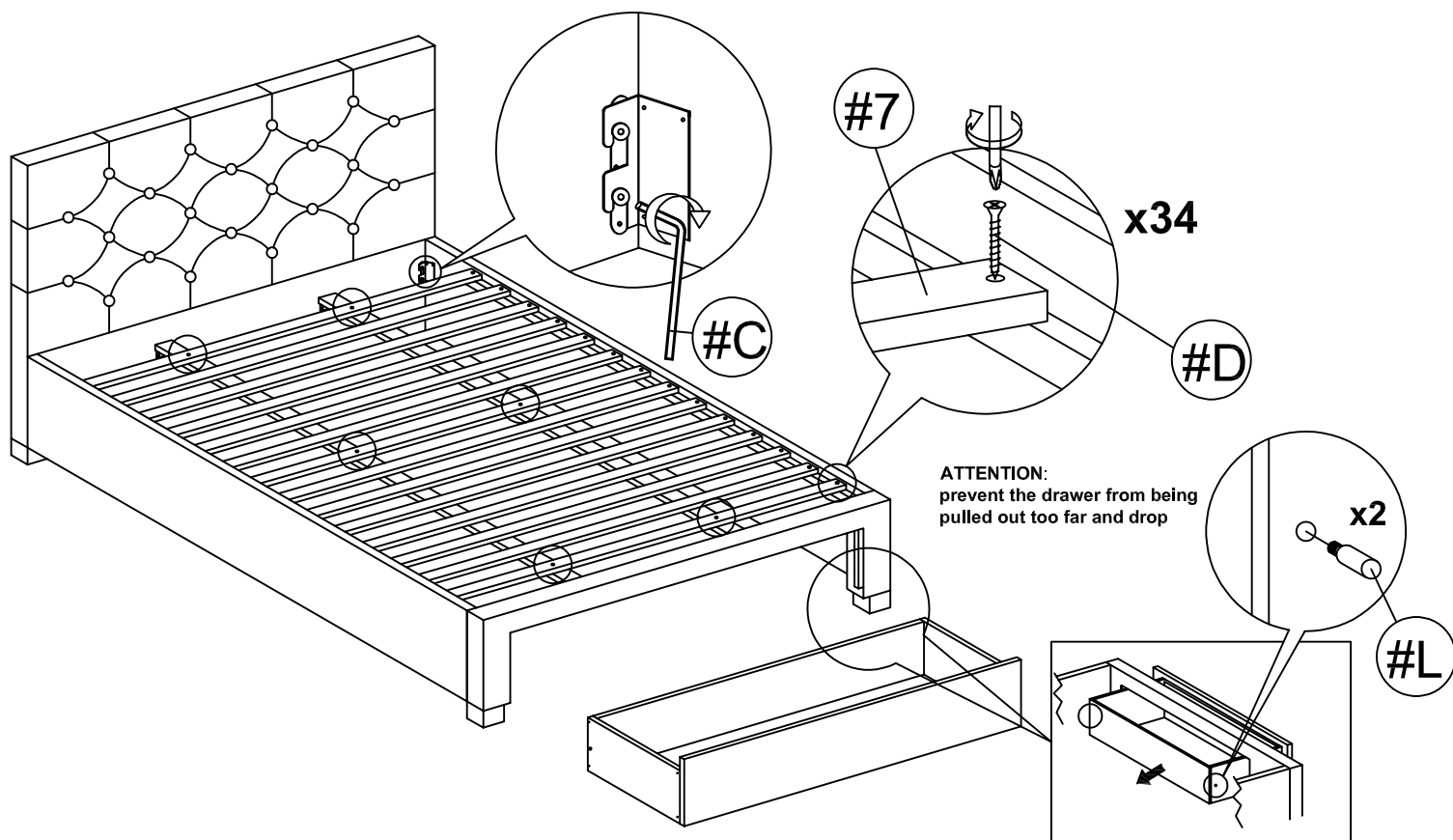

## ASSEMBLY COMPLETED



Please ensure the furniture rests on an even and flat surface. If the product wobbles or feels loose, double-check all bolts and/or screws are properly tightened and secured.

### ✓ Keep this handy!

Please retain this instruction manual and any order-related information for future reference.

### ✓ Lift, don't drag!

To avoid damage to product please always LIFT the product when transporting or adjusting the placement.