

BIRASIL

Playhouse

ASSEMBLY INSTRUCTION



WARNING

- 1.This product requires assembly by an adult.
- 2.It contains potentially hazardous sharp points and small parts in unassembled state,please keep out of reach of children.
- 3.This product needs to be kept away from fire
- 4.Avoid playing outdoors during thunderstorms



Not Suitable For Children
Under 3 Years Old

WARNING

Children must NOT use this play house until unit has been completely assembled and inspected by an adult to insure set has been properly assembled. Please follow all recommendations below. Failure to do so may result in the warranty being void and/or safety violations that could result in serious injury. This manual contains helpful information concerning Assembly Preparation, Installation Procedure, and Required Maintenance. Always keep the safety of your children in mind as your play structure is being built and as your children play with the unit. Before your children play with the unit please review the Operation Instructions with them to help ensure their safety.

ASSEMBLY TIPS, IT IS AS EASY AS 1,2,3

1. Please read the assembly instructions first and become familiar with the parts. If there are missing parts or parts are damaged, please feel free to contact us.

2. Proper assembly of this item requires 2 people.

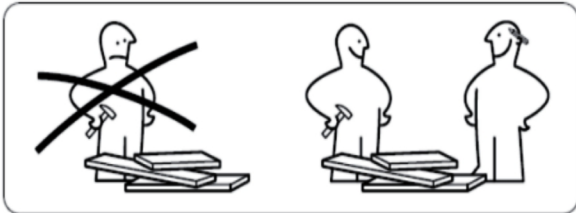

3. Unpack and assemble this unit in an spacious area, assemble the unit on top of the empty, carton or carpet to prevent scratches.

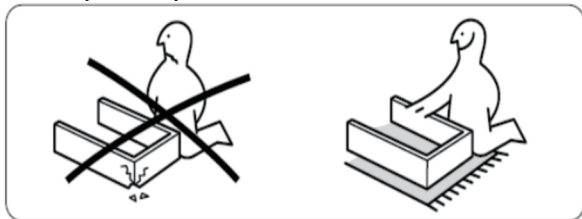

4. To avoid accidentally discarding small parts or hardware, DO NOT dispose of any contents until assembly is completed.

5. Do not fully tighten all bolts until all parts are in place. Failure to follow these instructions may cause the bolts to misalign during assembly.

6. There may be some peculiar smell when the product package is opened, but please rest assured to use it. Our products are all non-toxic water-based paint and the smell will disappear after a few days.

7. If there are crystals in the wood, this is naturally occurring in the fir wood. This is normal. Just wipe it clean and it can be used normally without affecting the health of your child.

8. This installation instruction is suitable for models KPD-1501, KPD-1502.

Pre-installation Instructions

1. When you open the package, you will find a lot of components and parts. You may feel a little confused about how to install this kids' playhouse. Don't worry, you will find the installation is actually quite simple once you follow our steps to install.

2. The play house is divided into two parts, a house and a sandbox.

3. The installation sequence is to install the house first, and then the sandbox. Before installation, first pick out all the parts of the house (From No. 1 to No. 20), the rest parts is for sandbox (From No. 21 to No.29). For more details, Please see the installation steps.

Hardware List

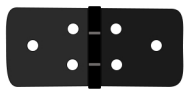

2PCS

A T-Shaped Hinge



2PCS

B M6 X 35



12PCS

C M6 X 45



7PCS

D 3.5 x60

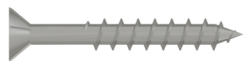

13PCS

E 3.5 X 40



140PCS

F 3.5X30



13PCS

G 3.5X20



13PCS

J 3.5 x15



12PCS

K 6MM Wood Dowel



9PCS

I 3.5X30



1PCS

M Wooden Door Latch

Playhouse Parts List



1 X 1PCS



2 X 1PCS



3 X 4PCS



5 X 2PCS

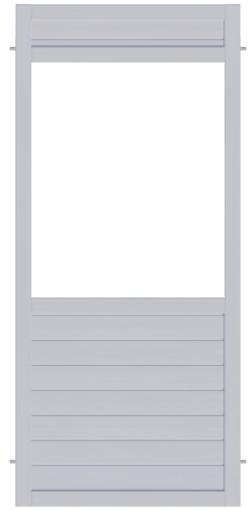

6 X 2PCS

No Pre-drilled holes



7 X 1PCS

The side with pre-drilled holes face outwards

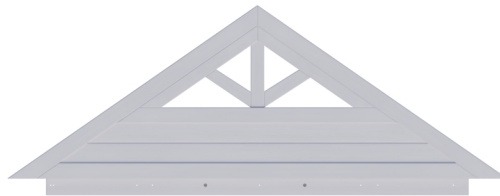

8 X 1PCS



10 X 2PCS

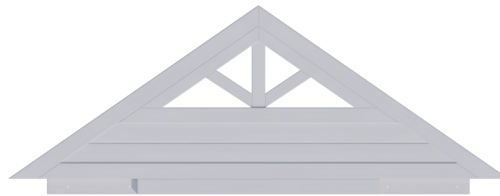

9 X 1PCS



11 X 2PCS



12 X 1PCS



13 X 2PCS



15 X 3PCS



16 X 4PCS



17 X 1PCS



18 X 1PCS



14 X 4PCS



19 X 2PCS



20 X 2PCS

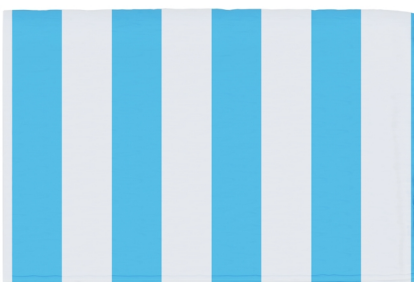

4



30

Sandbox Parts List



21 X 2PCS



22 X 1PCS



23 X 1PCS

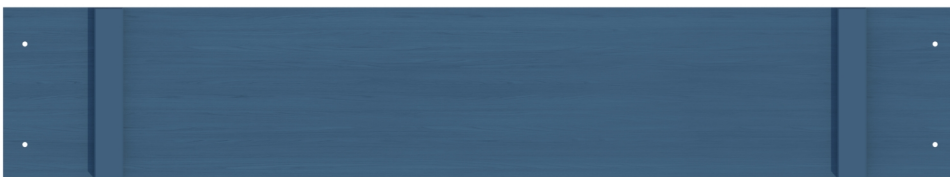

24 X 2PCS

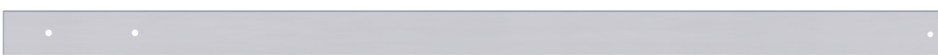

25 X 2PCS



26 X 1PCS



27 X 1PCS



28 X 3PCS



29 X 3PCS

Assemble Playhouse Part

Step1:

Install the front part of the play house. Attach board **1** **2** to the board **9**, and fasten with pre-drilled holes by using self-tapping screws **F**. As shown in the figure below:

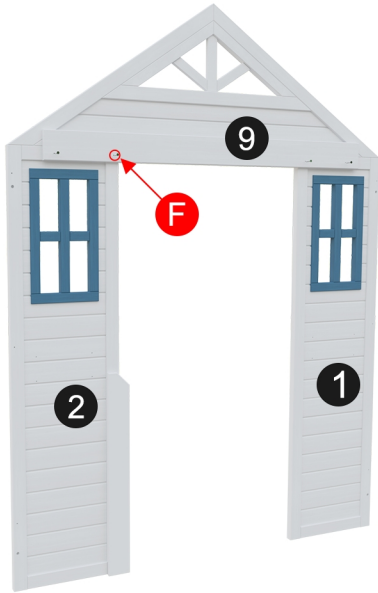

Step2:

Install the back part of the playhouse. When installing, first attach **8** to **6** and fix them by using self-tapping screws **F**, then install **5** **6**. Attach 2 pcs board **5** to the board **6**, fully tighten by using self-tapping screws **D**. Next, fix the top board **8** and the 2 pcs board **5** with self-tapping screws **F**. Finally, insert the wooden dowels **K** at the bottom to fix wooden strip **17** with self-tapping screws **F**. As shown in the figure below:

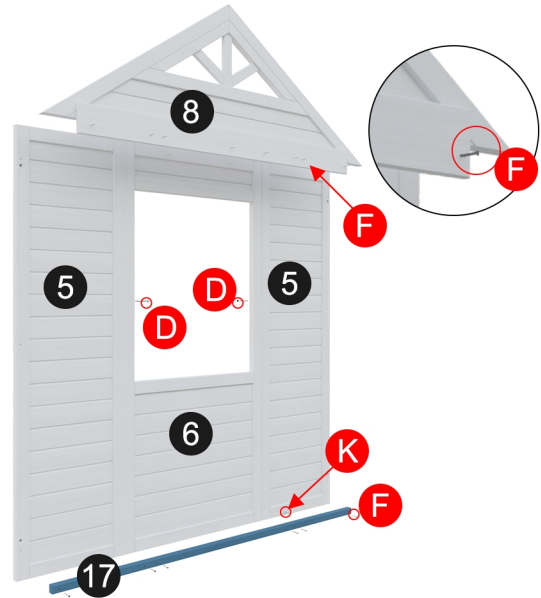

Step3:

Install left part of the playhouse. Assemble board **3** **6** together by using self-tapping screw **D** according to pre-drilled holes. Insert wooden strip **16** into the upper and lower part of the board **3** **6** by wooden dowel **K** and fix the board **3** **6** with strip **16** by using self-tapping screw **F**. As shown the figure below.

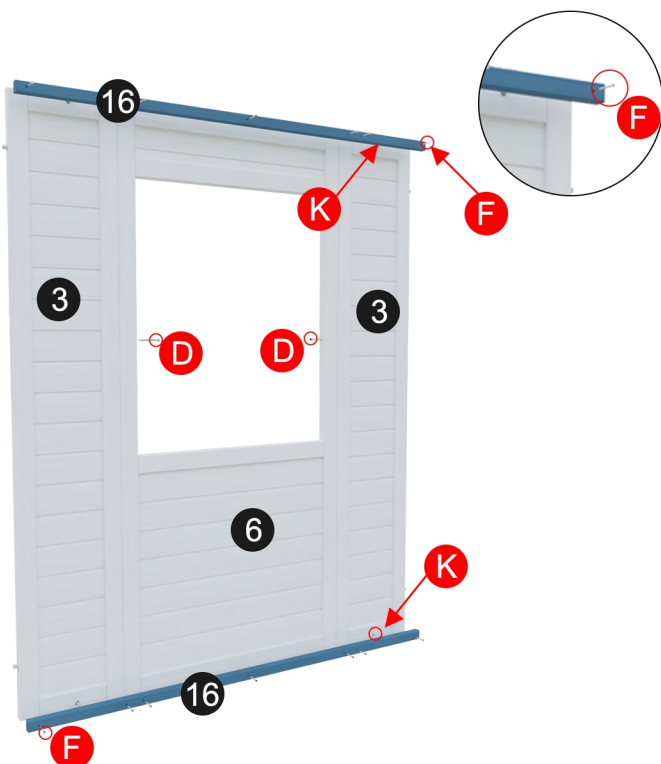

Step4:

Install Right part of the playhouse. Assemble board **3** **7** together by self-tapping screw **D** according to pre-drilled holes. Insert wooden strip **16** into the upper and lower part of the board **3** **7** by wooden dowel **K** and fix the board **3** **7** with strip **16** by using self-tapping screw **F**. As shown the figure below.

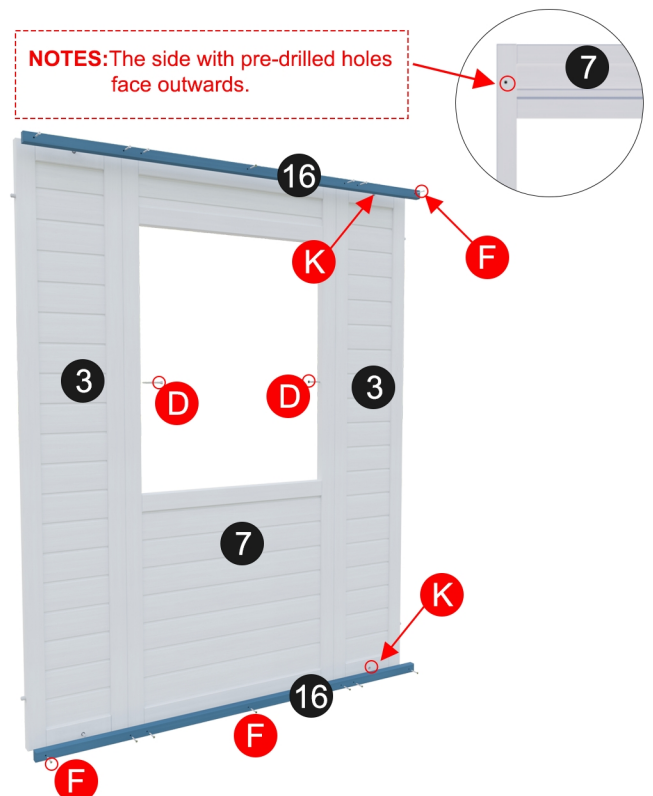

Step5:

Combine the assembled panels from **Step1** to **Step4** ,fasten by using self-tapping screws **E**. As shown in the figure below:

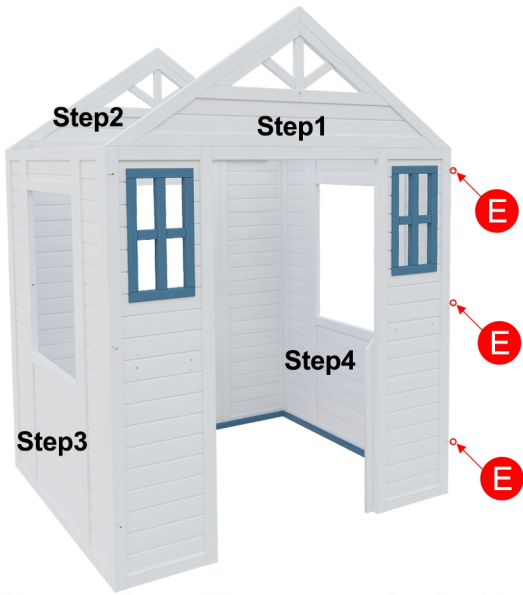

Step6:

Install the windows. Fix **15** on the window by using self-tapping screws **F**. As shown in the figure below:

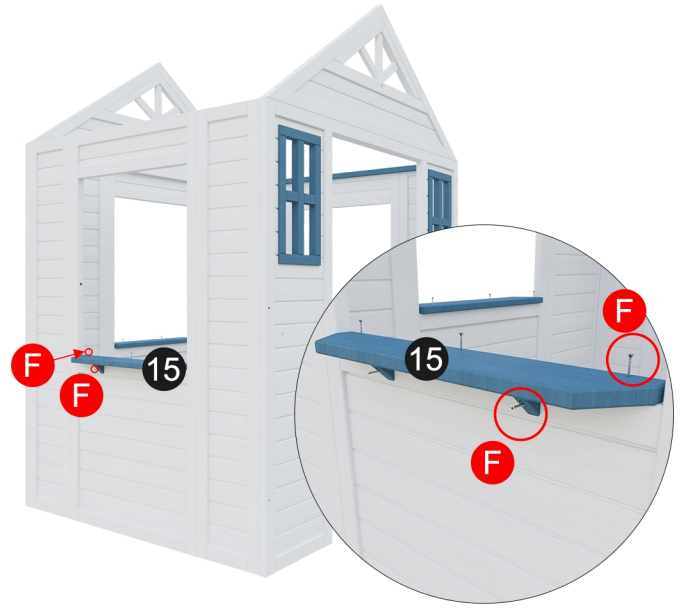

Please note that the difference between Step 3 and Step 4 is whether there are positioning holes for the wooden dowels K above the window. The side with the positioning holes is for installing the sandbox bracket. Before assembling, first confirm whether the sandbox is installed on the left or right side, and then install the window with the positioning holes on the left or right side to avoid being unable to place the sandbox after installation.

Step7:

Install the flower stand and the door, the hinge **A** can be installed according to the position below. Fix wooden bolt latch **H** by using screw **I**

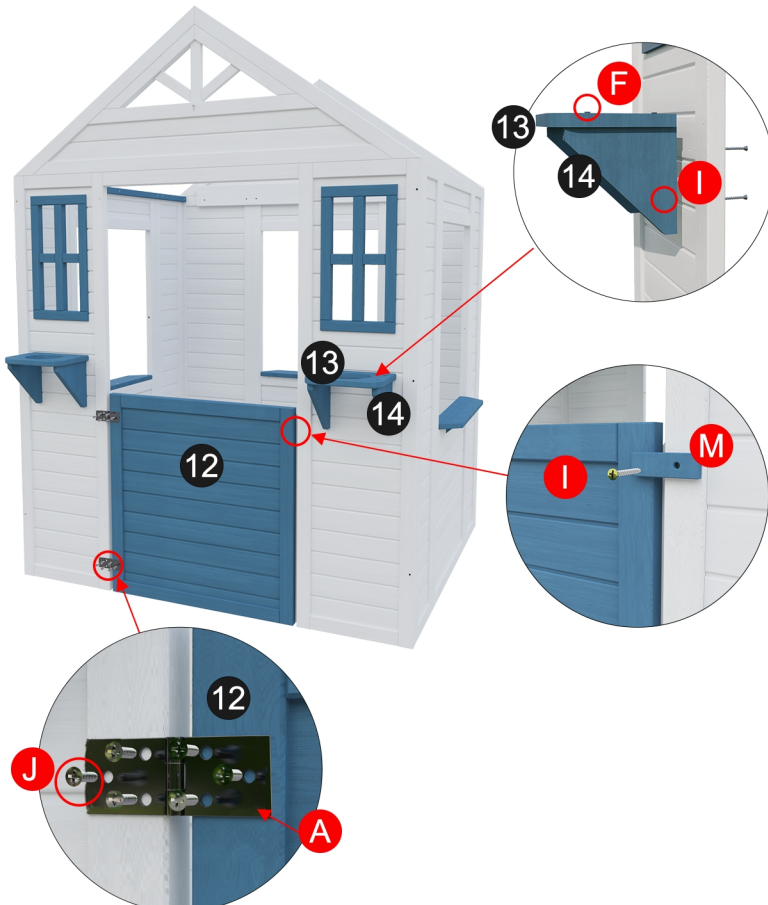

The house part has been assembled. Next, assemble the sandbox and roof parts.

Assemble the Sandbox

Step8 :

Install the base of bsandbox.

Step8-1 :

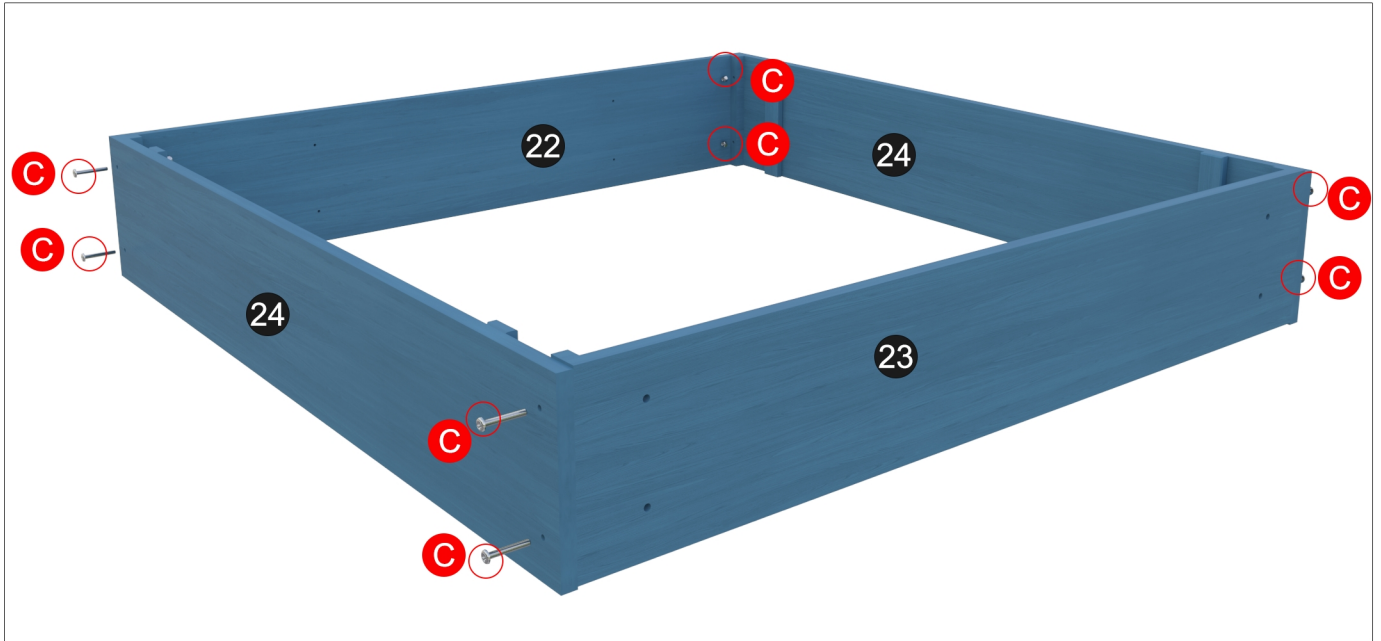

Step8-2 :

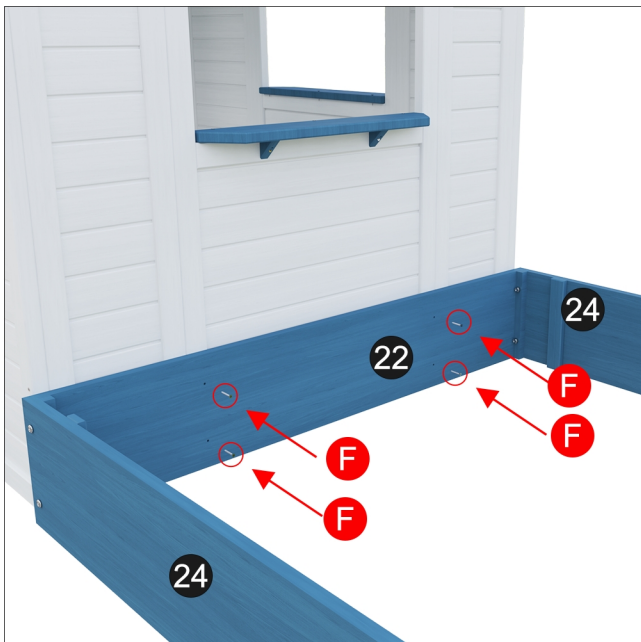

Step8-3 :

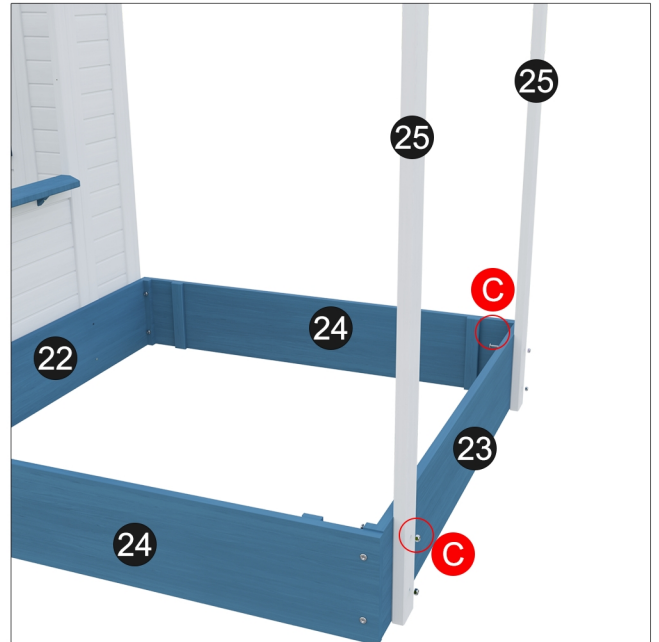

Step9 :

Install sandbox's canopy brackets.

Step9-1 :

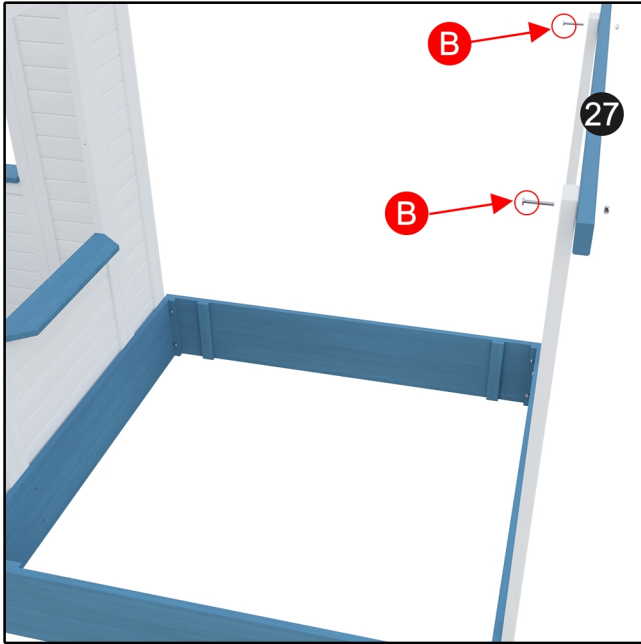

Step9-2 :

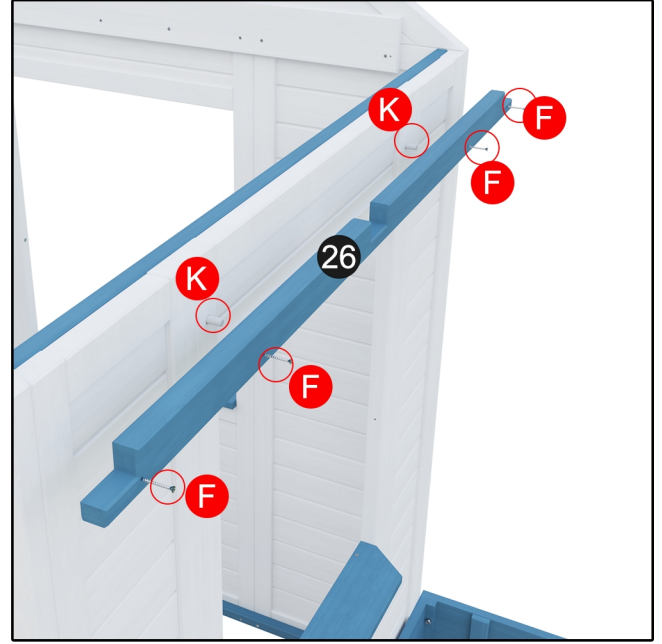

Step9-3 :

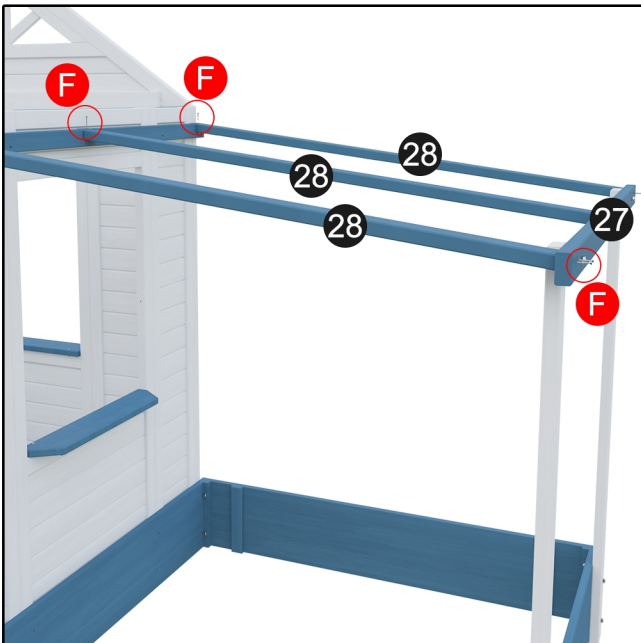

Step9-4:

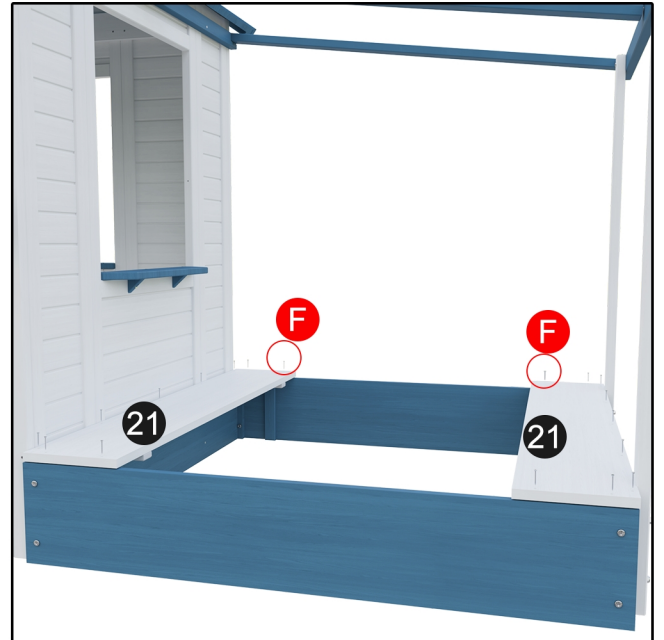

Step10:

Straighten the canopy **4**, fix the canopy with the fixing strip **29** by using self-tapping screws **G**.

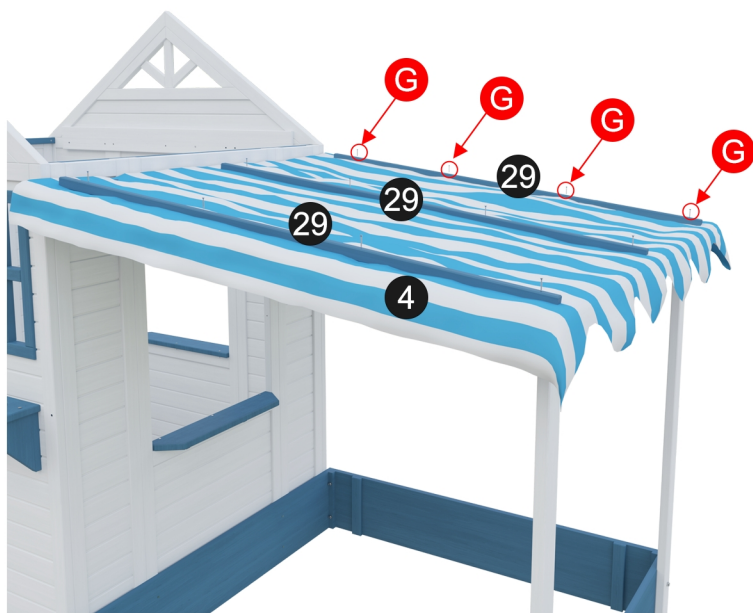

Step11:

First install the roof **10** and then install the roof **11**, fix them with self-tapping screws **F**.

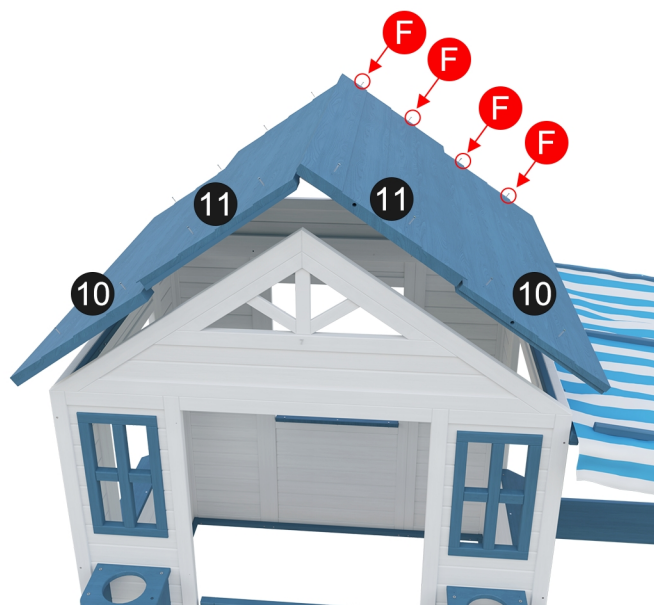

Step12:

First Install the eaves **19** **20** (There will be some gaps after the wooden dowels are positioned and connected, so the 2 eaves need to be spliced together first and fixed by using self-tapping screws **F**). After the eaves are installed, finally install the roof cap **18**.

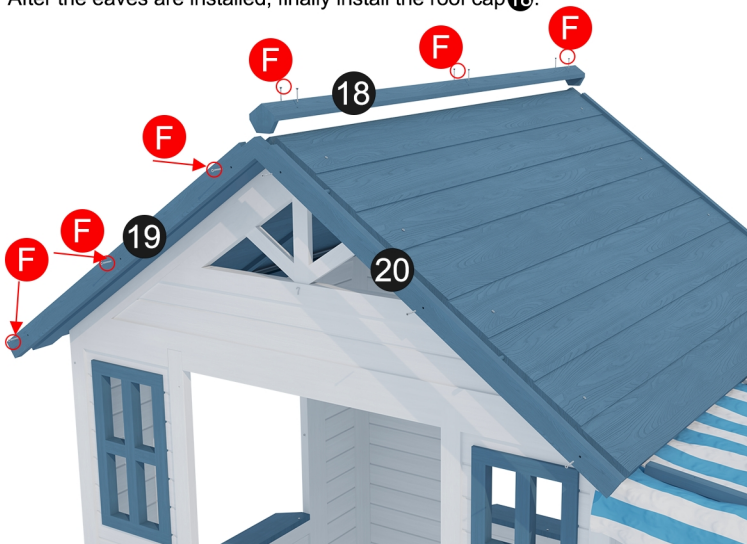

Step13:

Finally, put the non-woven fabric on the bottom.

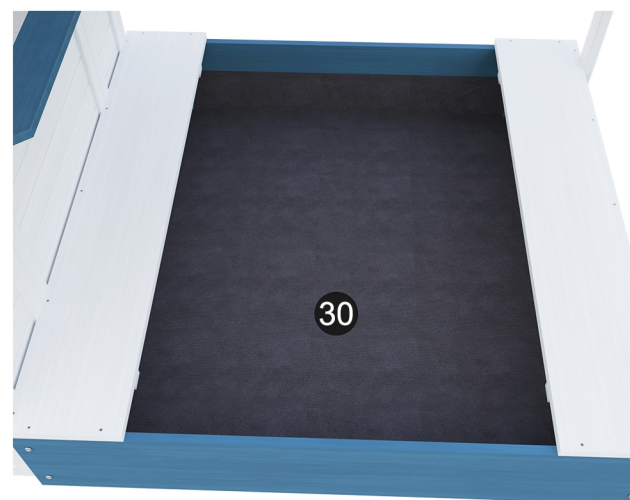

BIRASIL



Material : Wood

Item No. : KPD-1501,KPD-1502

Need help : Birasil-service@outlook.com

Name Of Manufacturer: Xiamen Chengyi Technology Co., Ltd.

Address Of Manufacturer : Unit 1,Room306,No.998-1000,Anling Road, Huli, Xiamen