

# Assembly Instructions

## CAUTION



• Inspect the wire insulation for any cuts, abrasions, or exposed copper that may have resulted during shipping. If there is a defect in the wire, do not attempt installation.

• Before starting installation of this fixture or removal of a previous fixture, disconnect the power by turning off the circuit breaker or by removing the fuse at the fuse box.

## TOOLS REQUIRED



Ladder



Safety glasses



Electrical tape



Phillips screwdriver



Flat blade screwdriver



Pliers

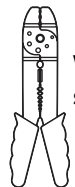

Wire strippers

## HARDWARE INCLUDED

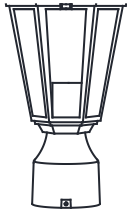

Fixture



Decorative Nut



Cover



Mounting Screws



Wire Nuts

**\*PARTS SHOWN MAY DIFFER SLIGHTLY PER LIGHT FIXTURE**

## INSTALLATION

### STEP 1

Unscrew the **mounting screws** from the **fixture**.

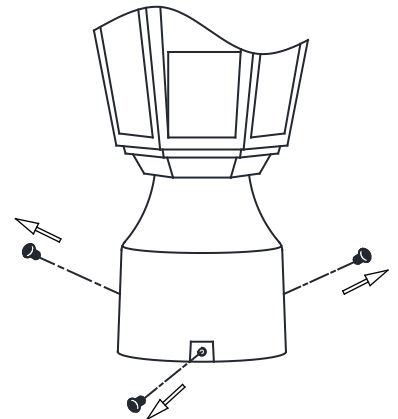

### STEP 2

Make the electrical connection from the junction box to the **fixture**. Connect the ground wire to the **mounting unit** using the preinstalled green ground screw. Then, connect the positive, negative and ground wires with the supplied **wire nuts**. Secure with electrical tape.

Connect Clear, Brown, Gold or Black Parallel Wire without tracer (round & smooth) or Black Fixture Wire to:

Black or Red Supply Wire or Insulated Wire (other than green) with copper conductor.

Connect Clear, Brown, Gold or Black \*Parallel Wire with tracer (square & ridged) or White Fixture Wire to:

White Supply Wire or Insulated Wire (other than green) with silver conductor

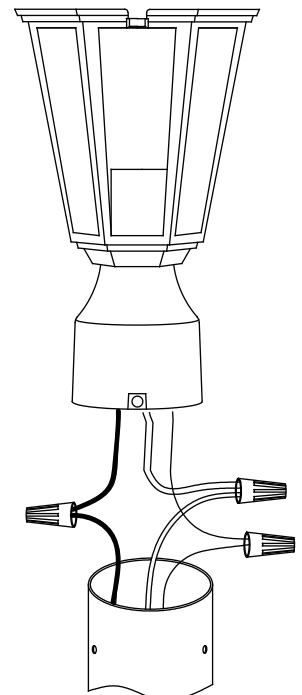
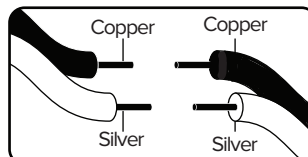

# Assembly Instructions

## INSTALLATION

### STEP 3

Attach the **fixture** to the post through **screw holes** as shown, and secure it with **screw**.

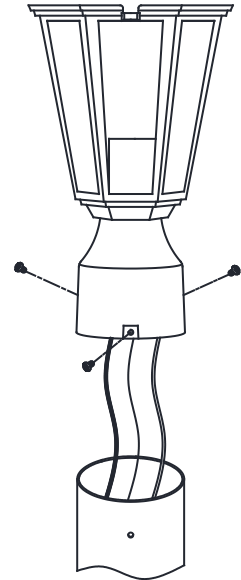

### STEP 4

Install bulbs (not included).

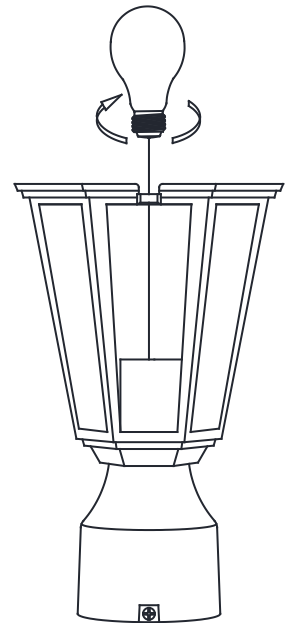

### STEP 5

1. Unscrew the **washer and hex nut** from the **decorative nut** . Use the **washer and hex nut** to attach the **decorative nut** to the **cover**.
2. Unscrew the **ball nuts and rubber ring** from the **cover** . Use the **ball nuts and rubber ring** to attach the **cover** to the **fixture**.

