

# ASSEMBLY INSTRUCTIONS

## BED - KING

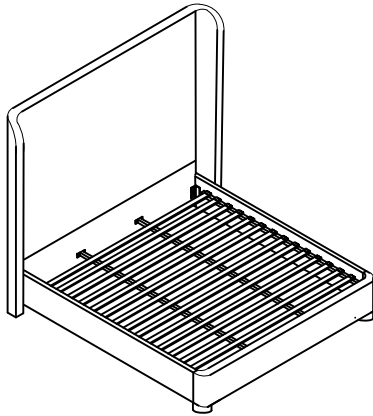

### + Parts Included

① Head Board  
(1pc)

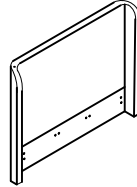

② Foot Board  
(1pc)

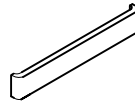

③ Side Rails  
(2pcs)

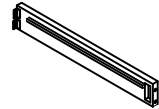

④ Center Support Bar  
(2pcs)



⑤ Support Legs  
(4pcs)

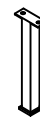

⑥ -Legs(2pcs)



⑦ Slats joint  
(1set=13pcs)

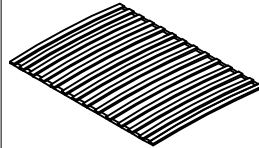

\*Slats come packed in the bottom of headboard carton.

+ Do Not Use Power Tools



+ Suggested Adults

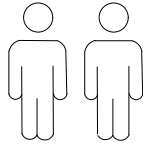

NOTE:

- 1 Read instructions cover to cover.
- 2 Save all packaging until assembly is completed.

### 1 IMPORTANT SAFETY INFORMATION

Do not assemble the product if any of the following parts arrived damaged:

- Part #③ -Side Rails
- Part #④ -Center Support Bar
- Part #⑤ -Support Legs
- Part #⑦ -Slats joint

### 2 IMPORTANT ASSEMBLY INFORMATION

Assembly Step ② Ensure the side rail bracket is fully hooked onto bolt A loosely threaded with both washers on the OUTSIDE of the bracket first, then proceed to fully tightening all 4 corners.

\*Slats come packed in the bottom of headboard carton.

### + Hardware Included

A Bolt M8\*40mm  
(20pcs)



B Bolt M8\*115mm  
(4pcs)



C Spring Washer  
(4pcs)



D Bolt M8\*70mm  
(4pcs)



E Flat Washer  
Φ20(28pcs)



F M8 Allen Key  
(1pc)



G Spanner  
(1pc)



H Nut M8\*13mm  
(12pcs)



# ASSEMBLY INSTRUCTIONS

## BED - KING

