



Instruction Manual

Thanks a lot your support and purchasing.

Please feel free to contact us if you have any questions with assembly or need replacement parts.

Assembly Instruction

Decorate your home, Brighten wonderful life

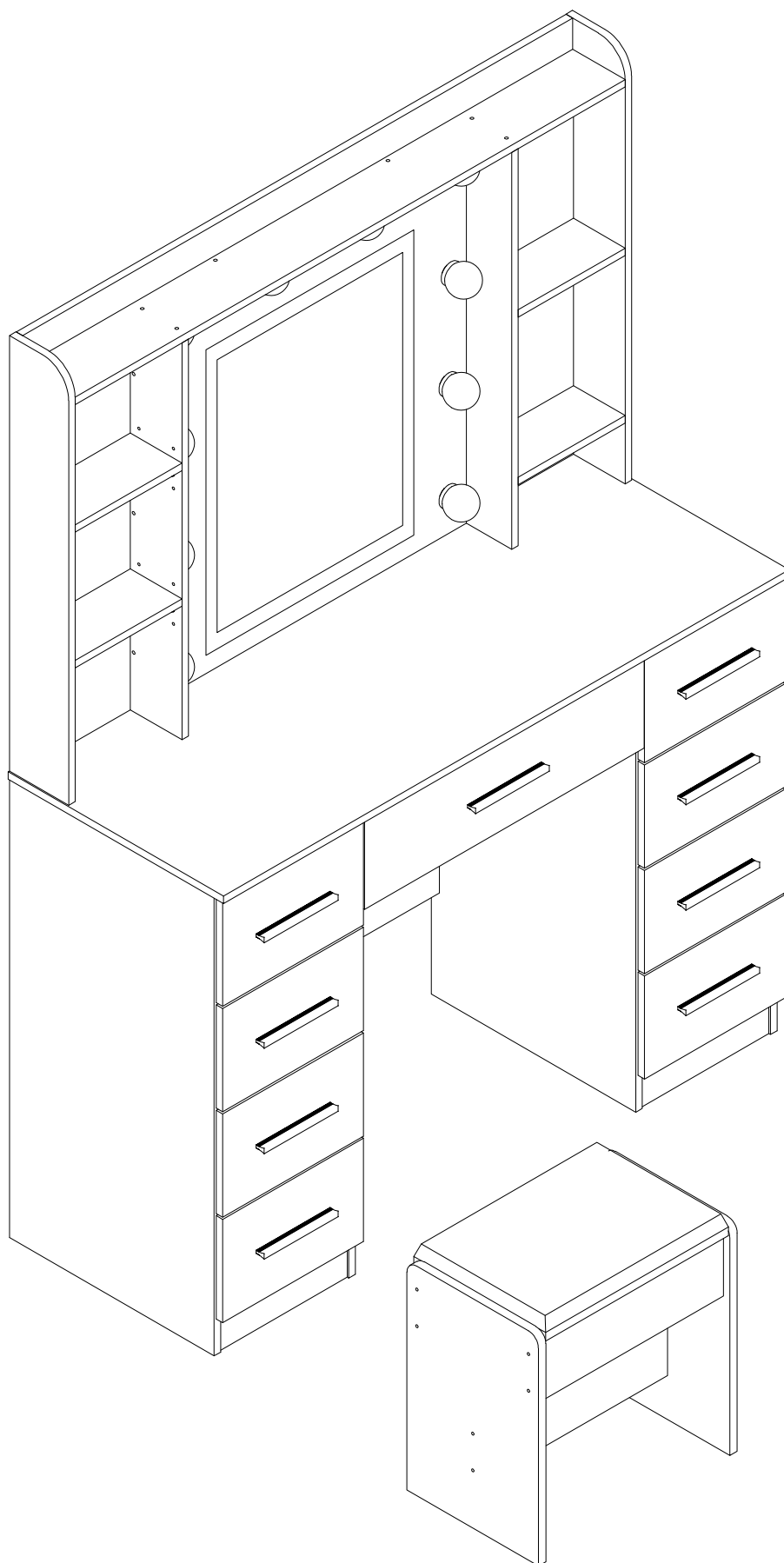

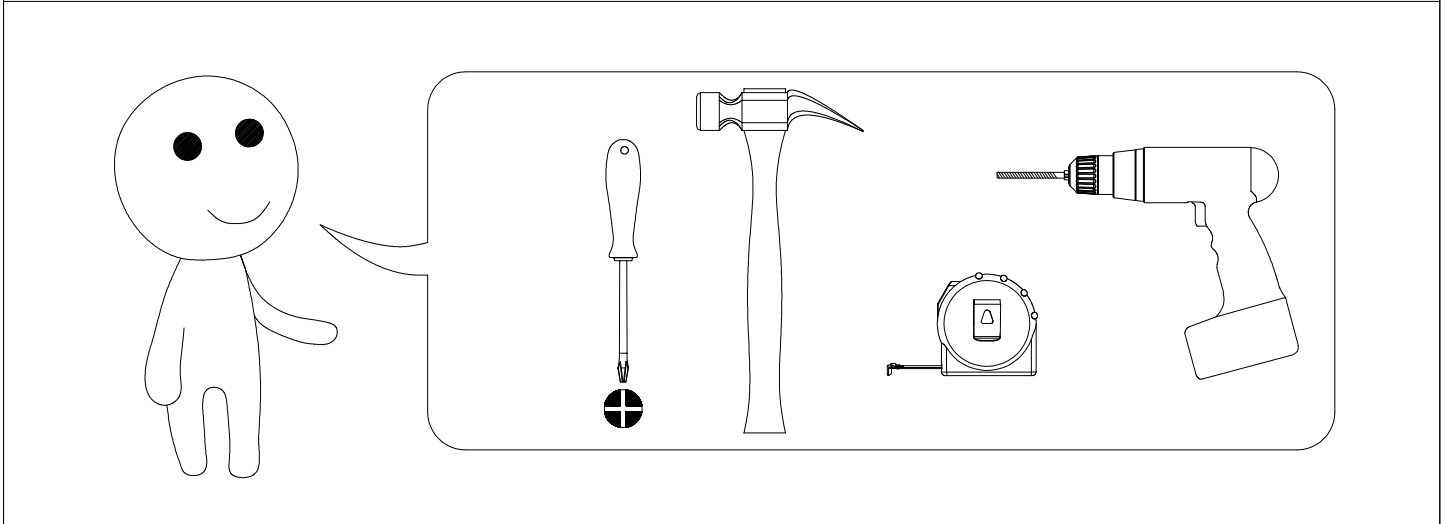
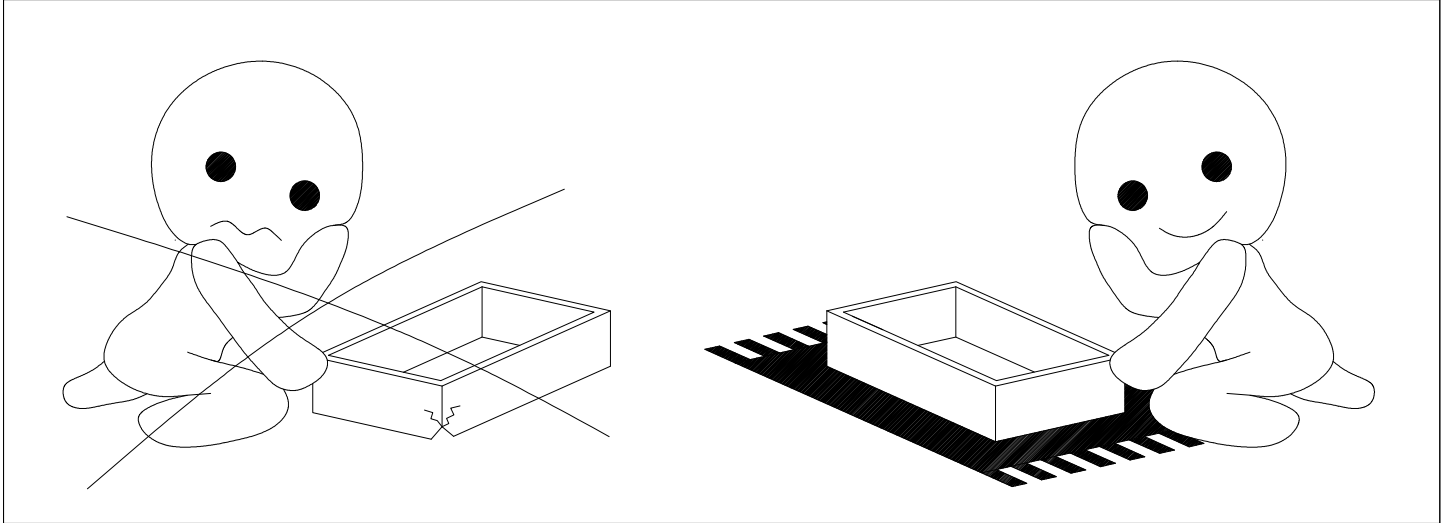
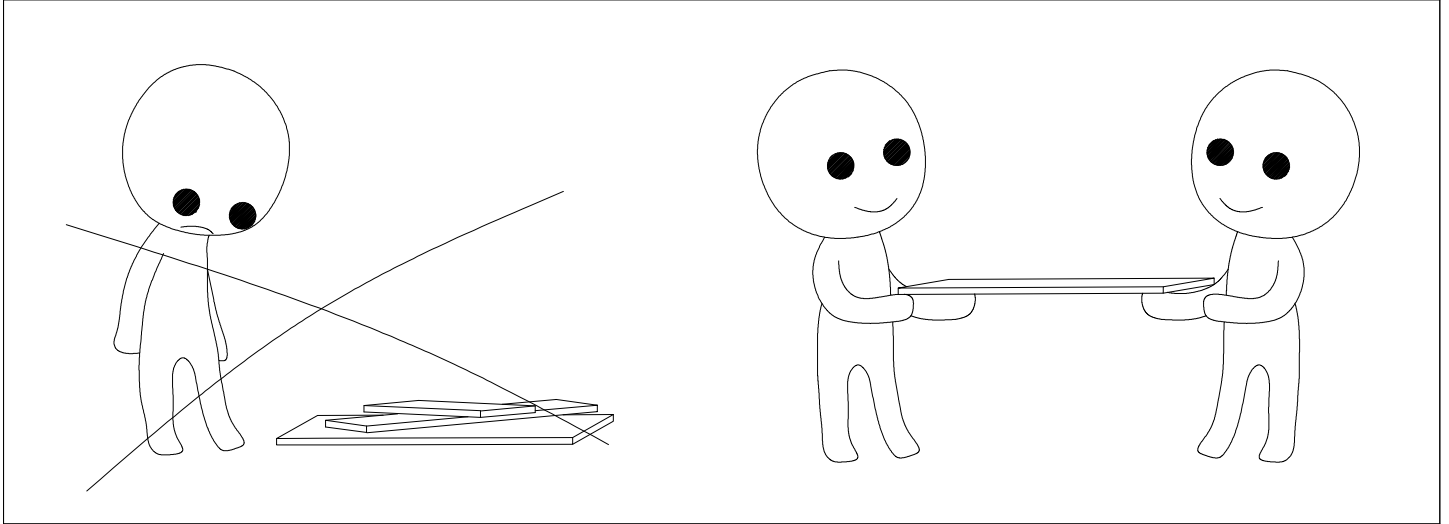
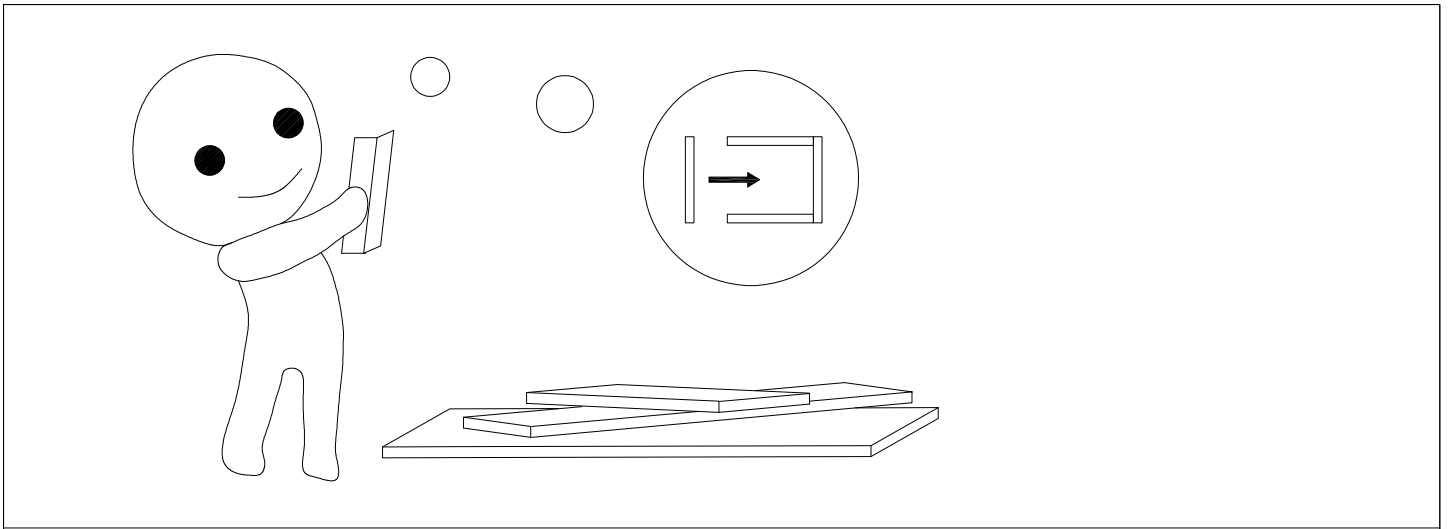
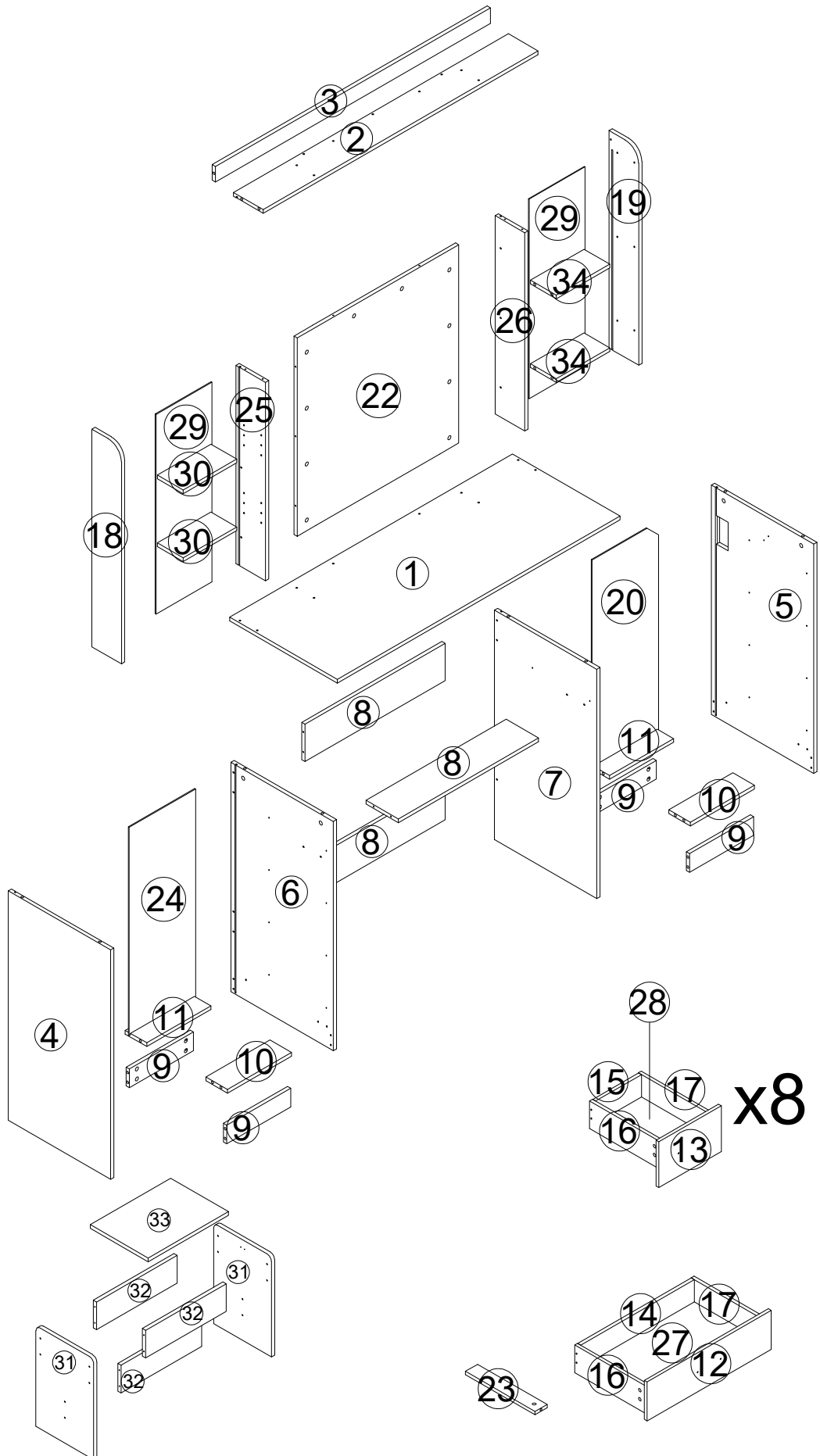
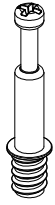

PLATE NUMBER



ACCESSORIES LIST

A ×87



M6×35

B ×87

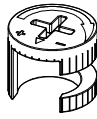

12×10

C ×86



M5×40

D ×72

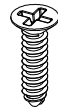

M3×12

E ×9

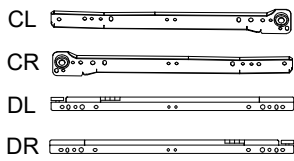

M300

F ×8

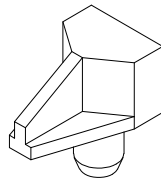

G ×5



H ×9

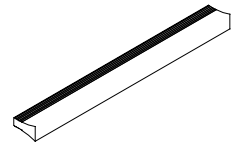

J ×18

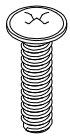

M4×14

K ×10

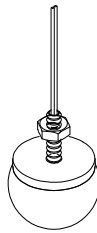

L ×1

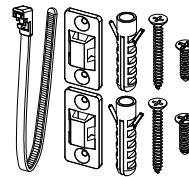

M ×10

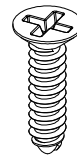

M3.5×12

N ×1

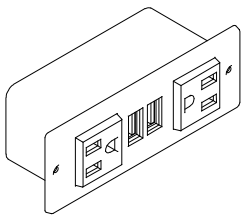

P ×1

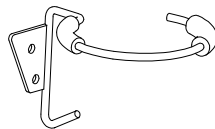

Q ×2

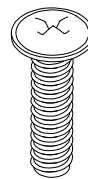

M4×20

R ×2

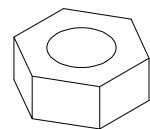

M4

S ×2

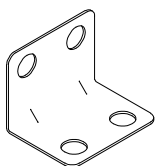

T ×10

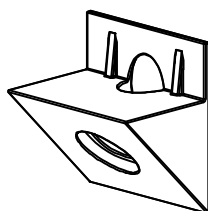

U ×10

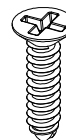

M3.5×14

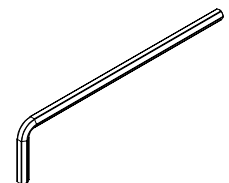

STEP 1

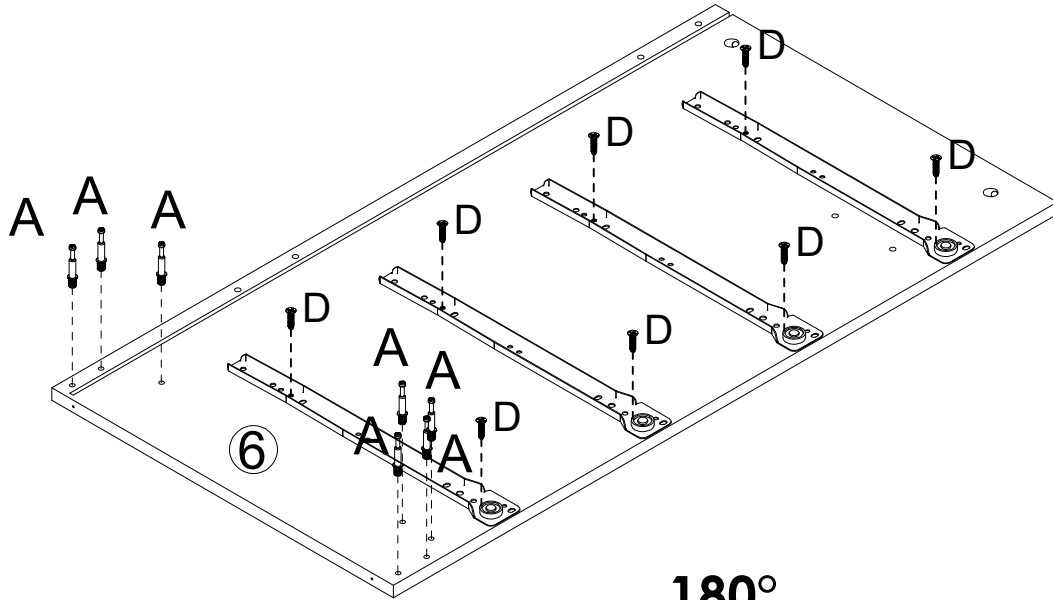
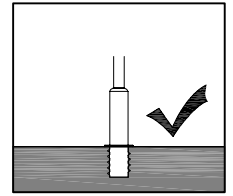
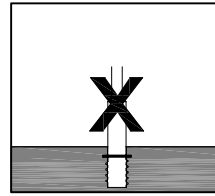
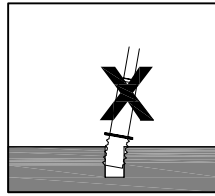
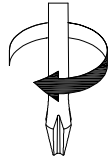

180°

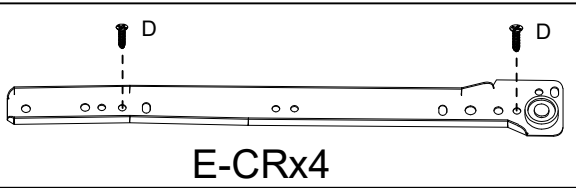

E-CRx4

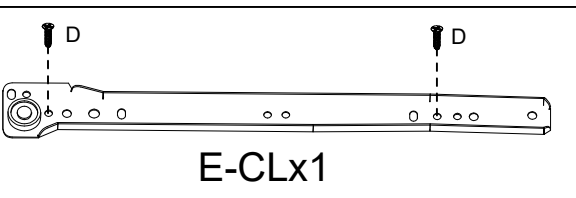
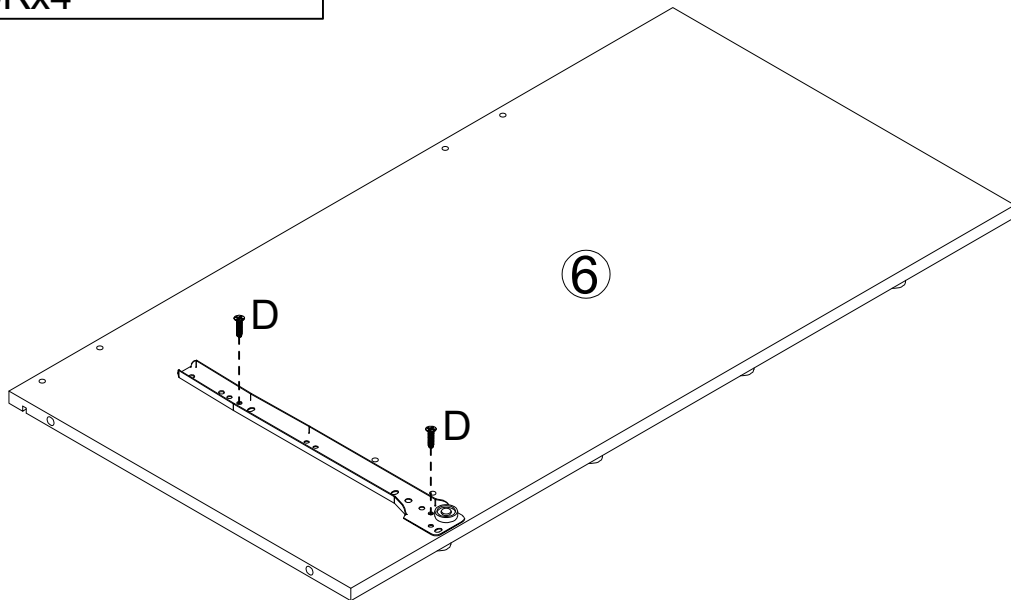

E-CLx1

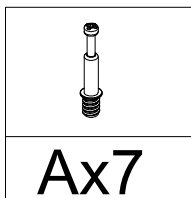

Ax7

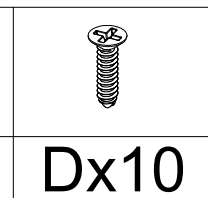

Dx10

STEP2

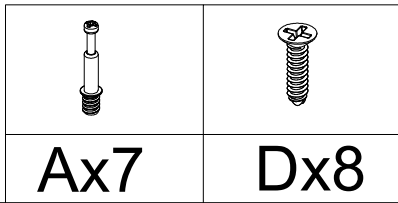
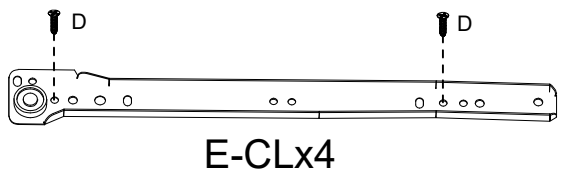
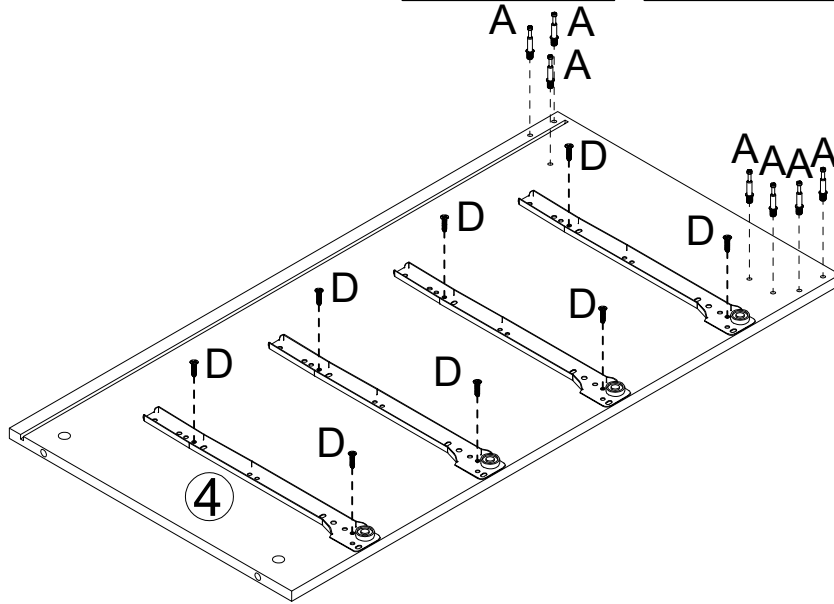
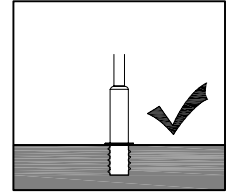
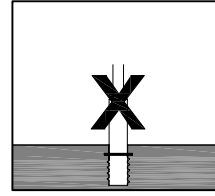
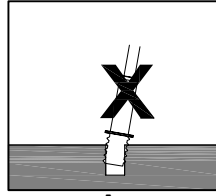
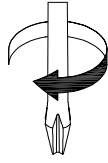

STEP3

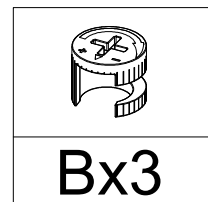
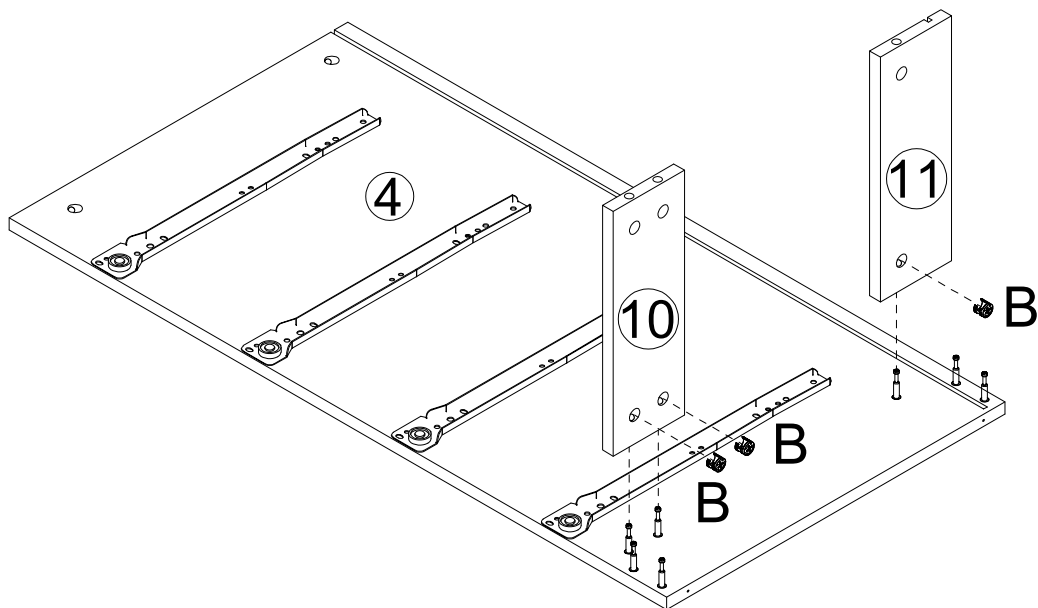
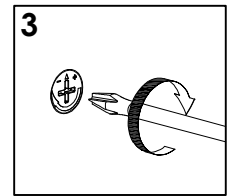
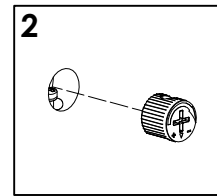
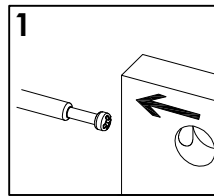
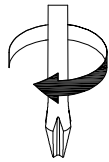

STEP4

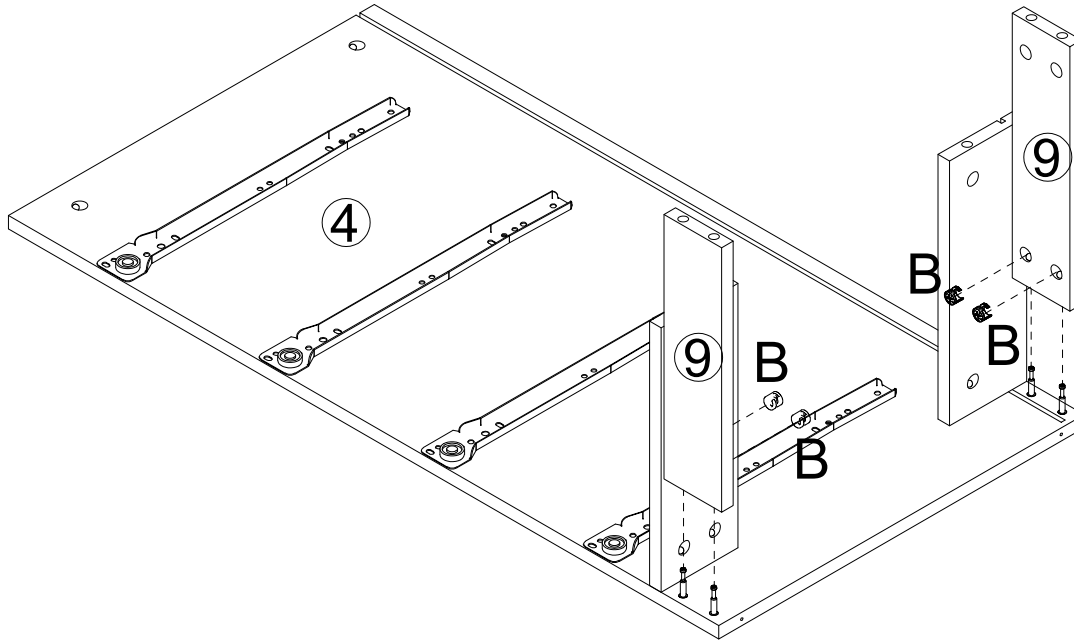
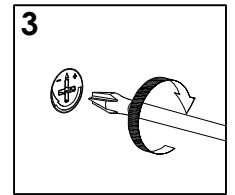
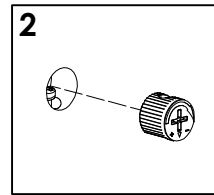
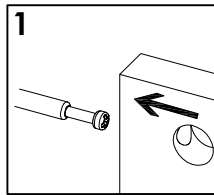
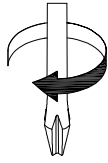

Bx4

STEP5

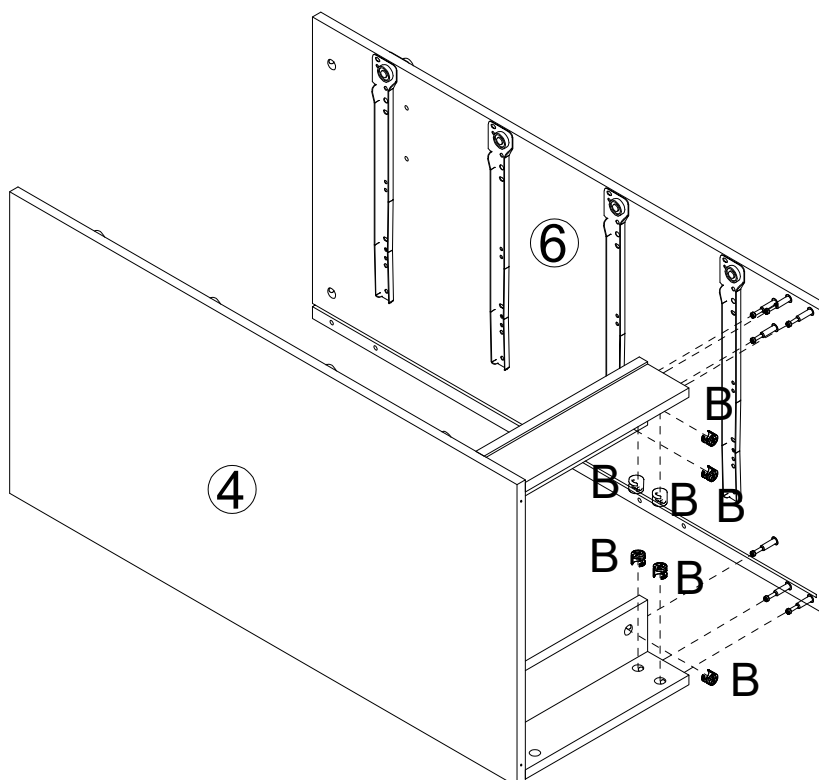
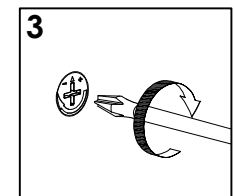
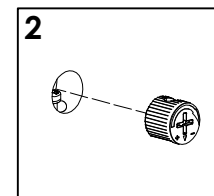
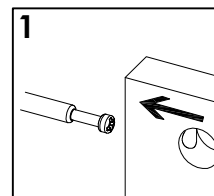
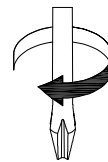

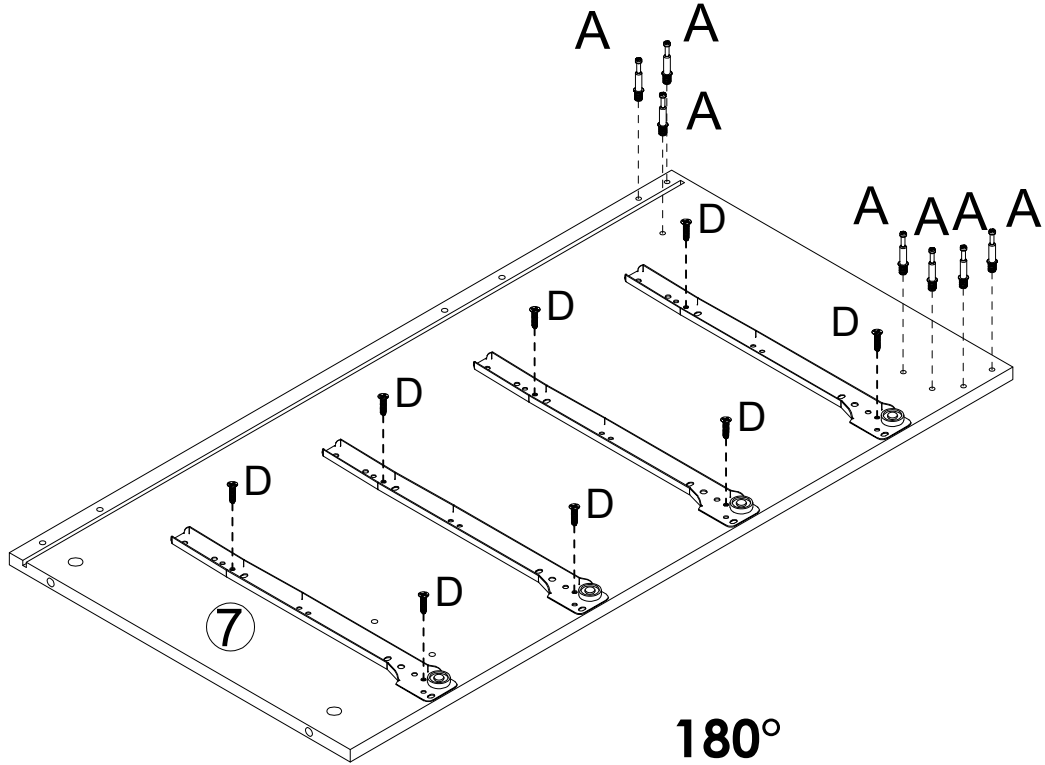
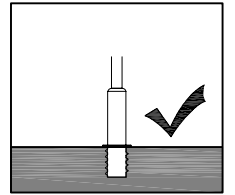
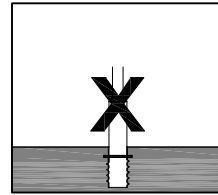
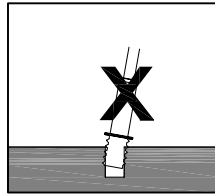
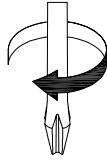

Bx7

STEP 6

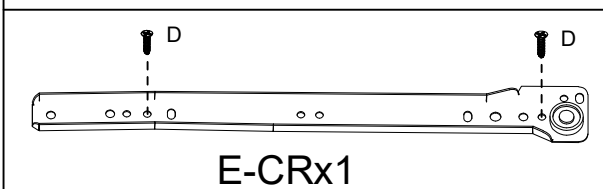
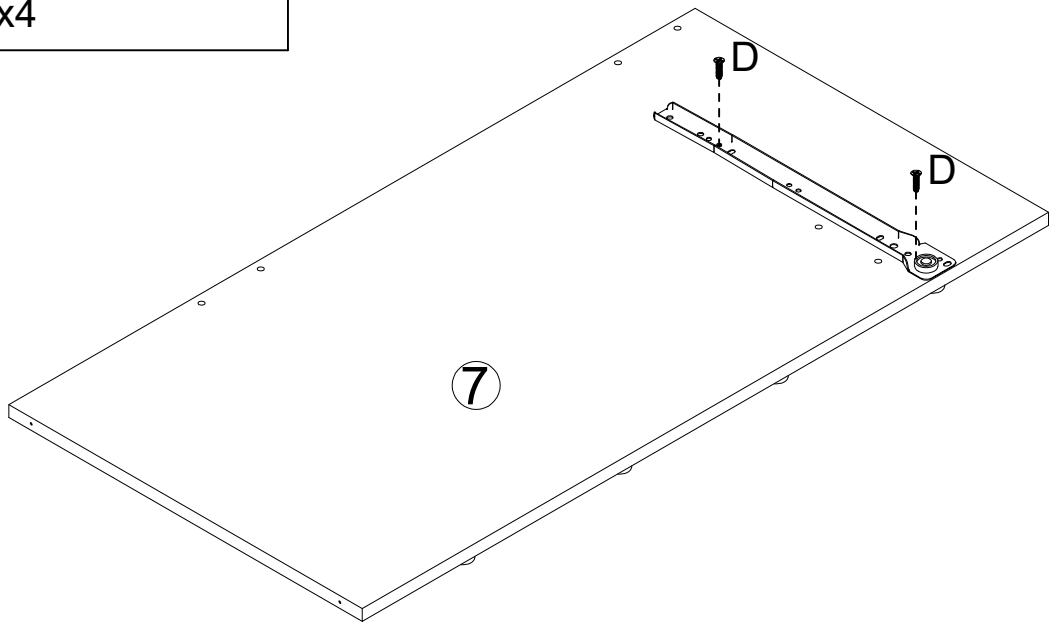
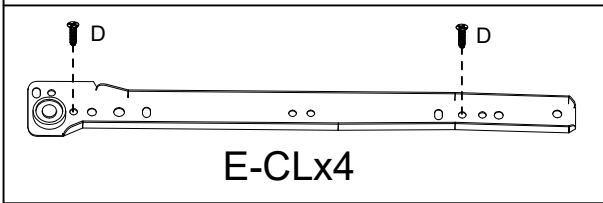

180°



	
Ax7	Dx10

STEP 7

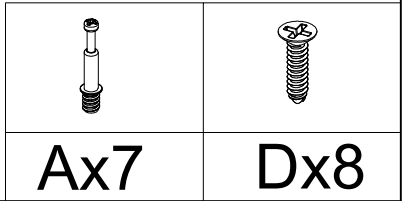
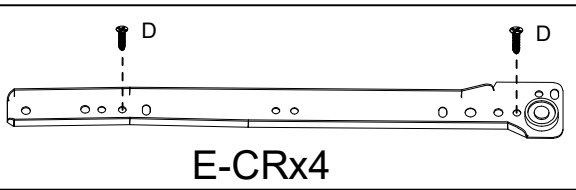
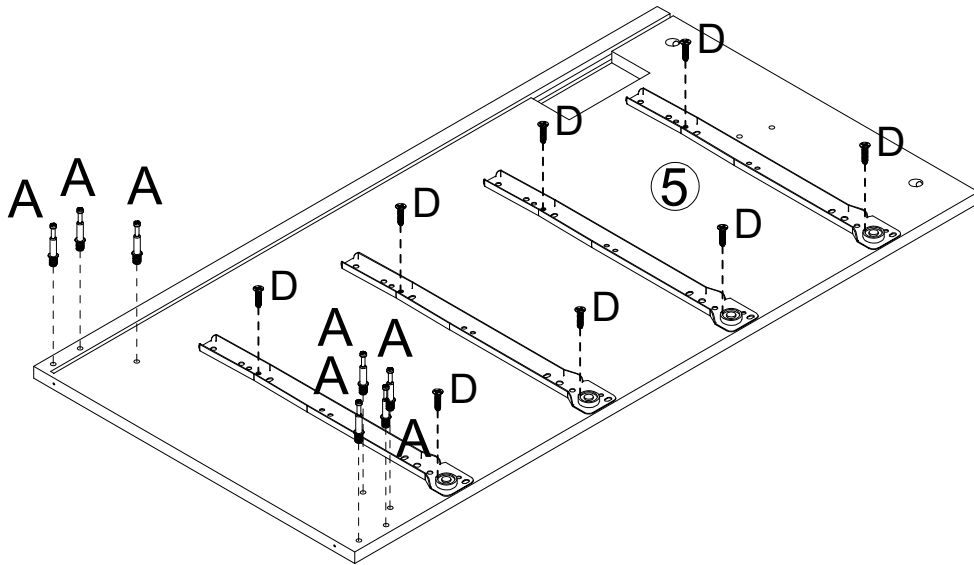
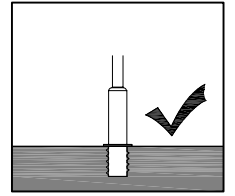
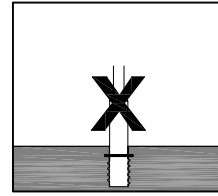
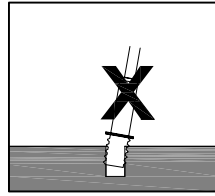
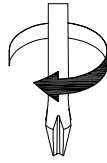

STEP 8

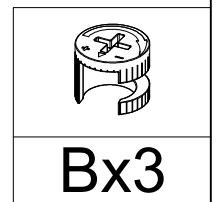
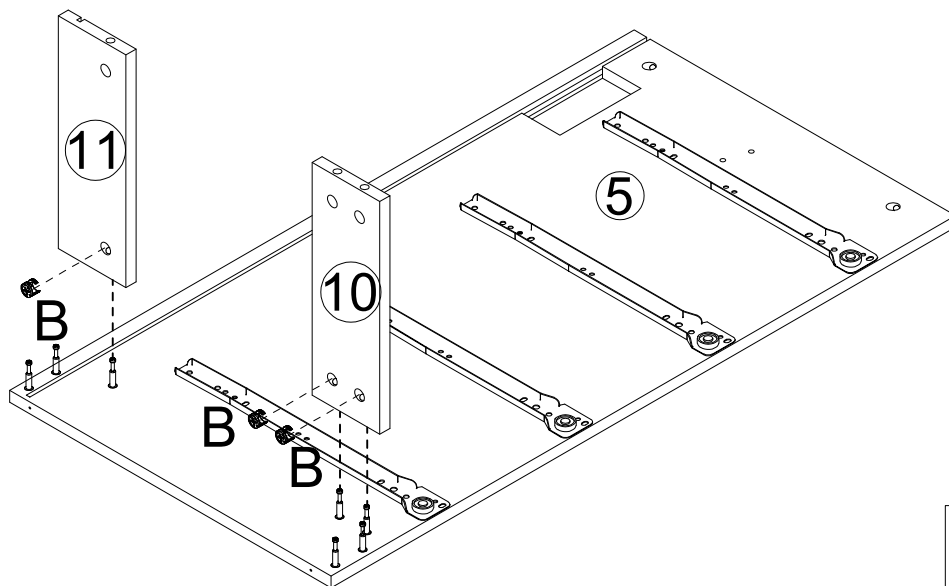
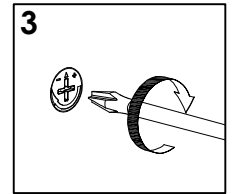
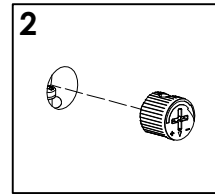
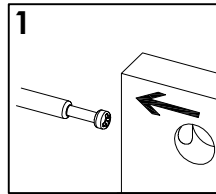
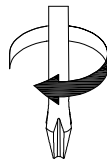

STEP 9

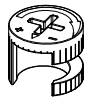
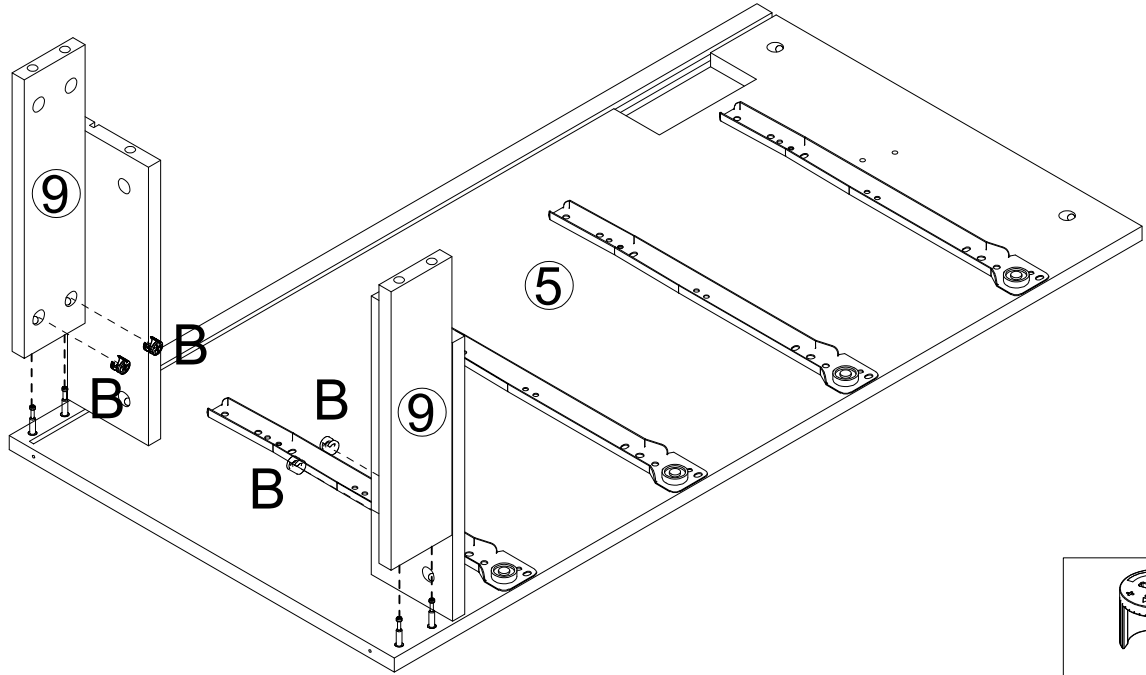
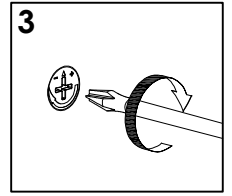
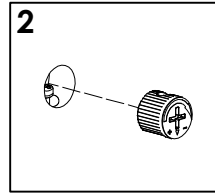
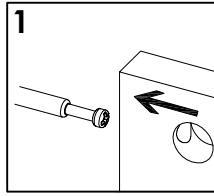
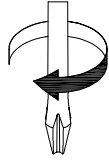

Bx4

STEP 10

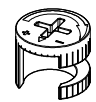
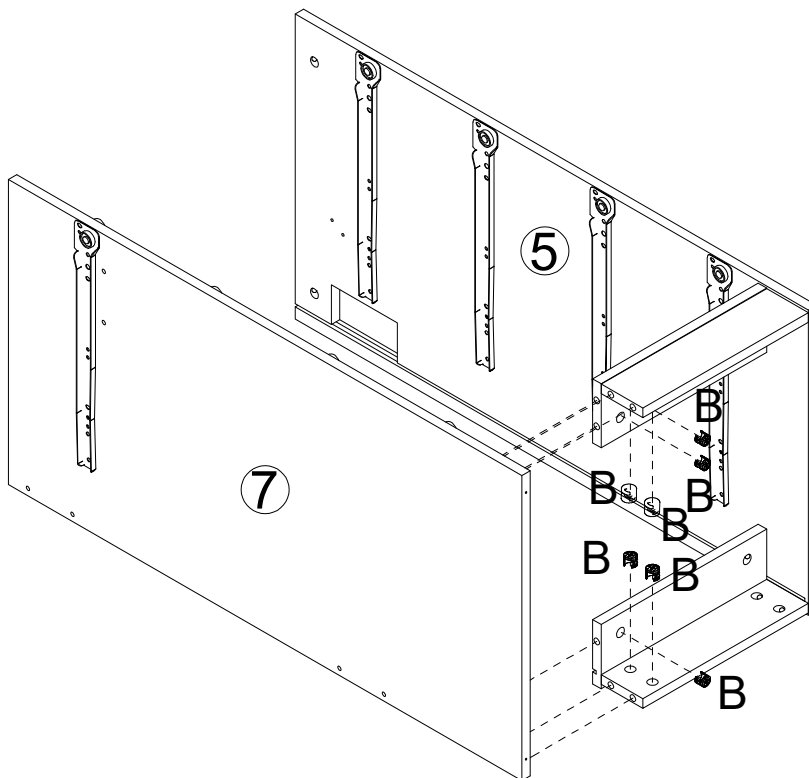
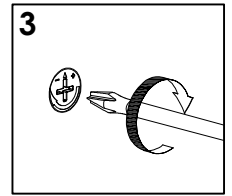
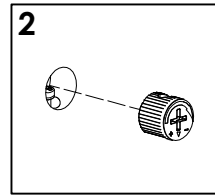
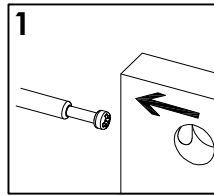
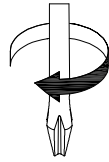

Bx7

STEP11

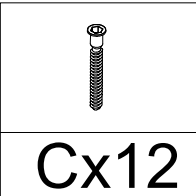
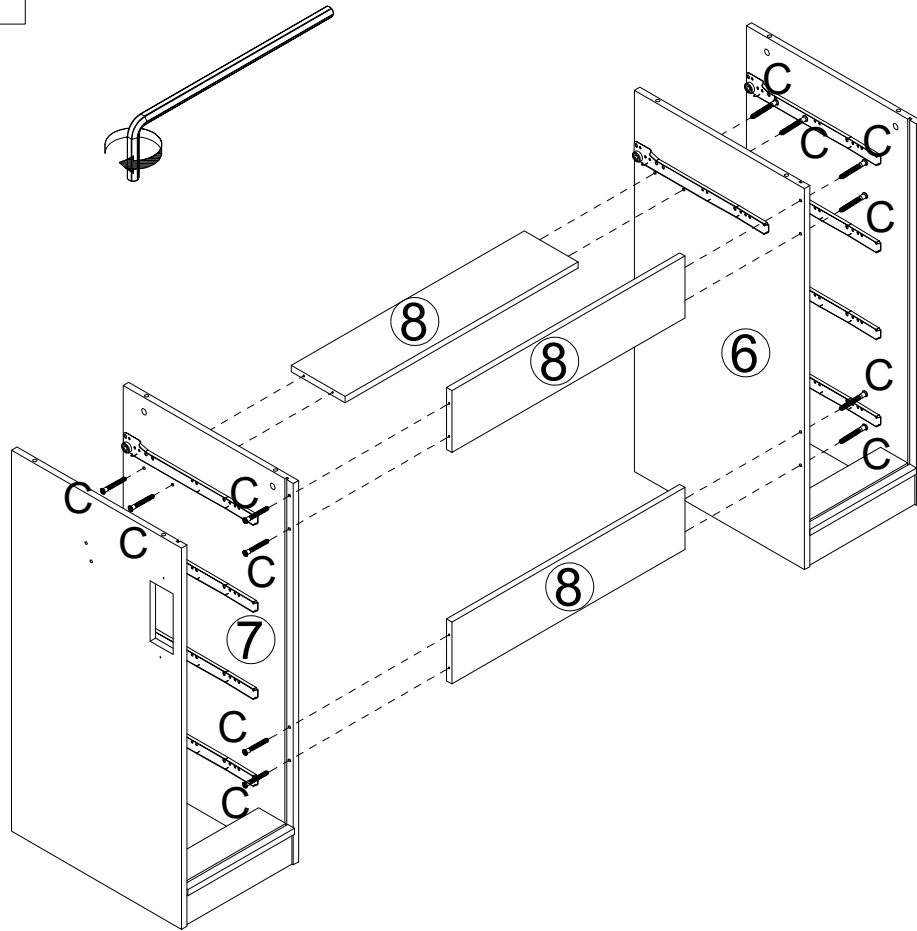



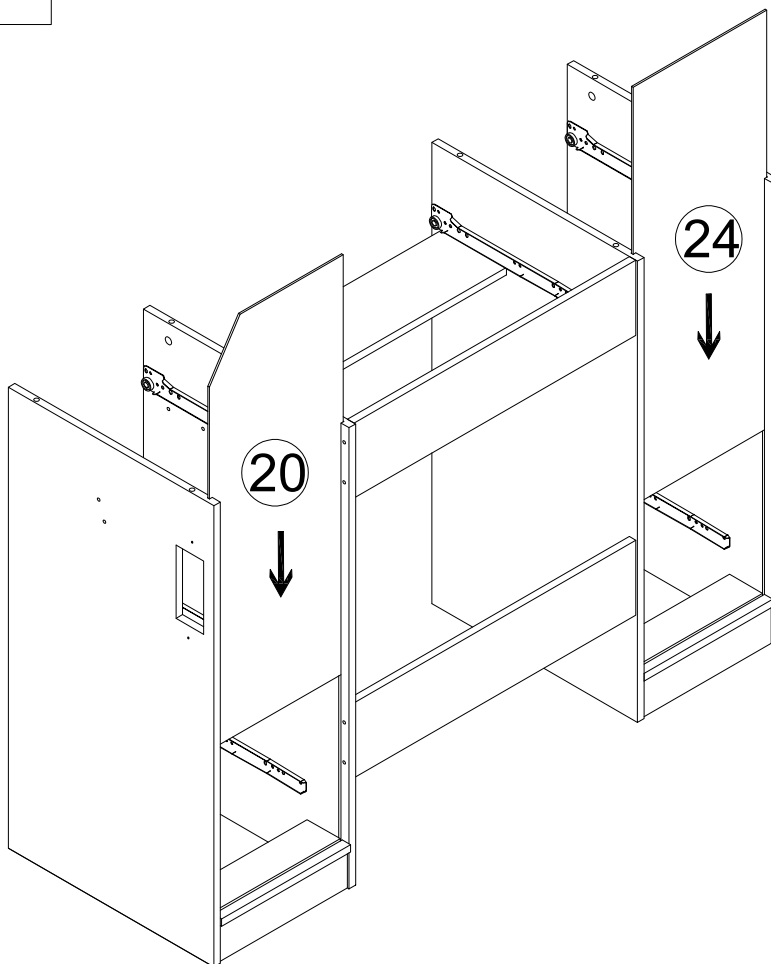

STEP12

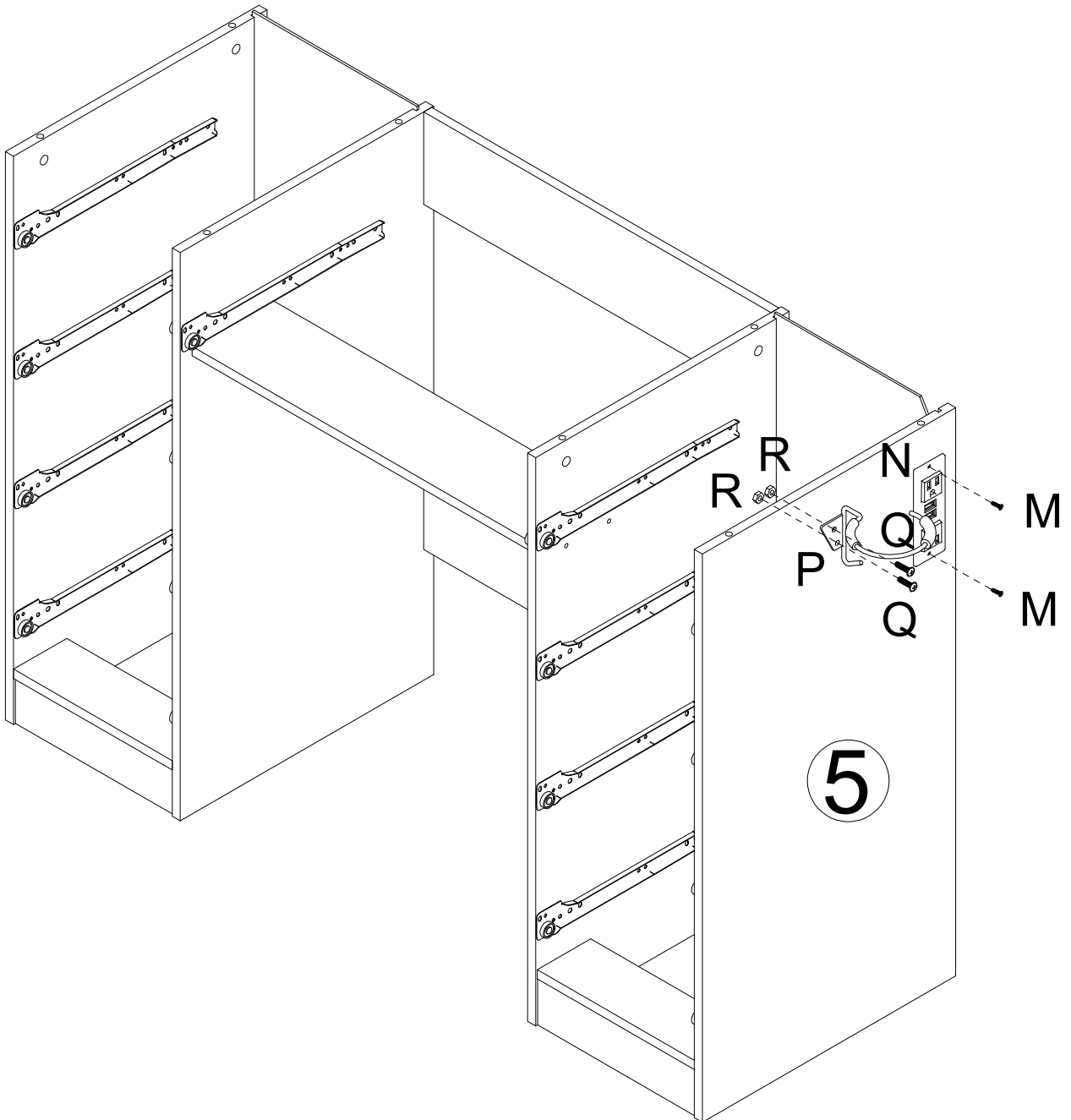
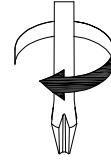

STEP 13

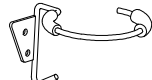

				
Mx2	Nx1	Px1	Qx2	Rx2

STEP14

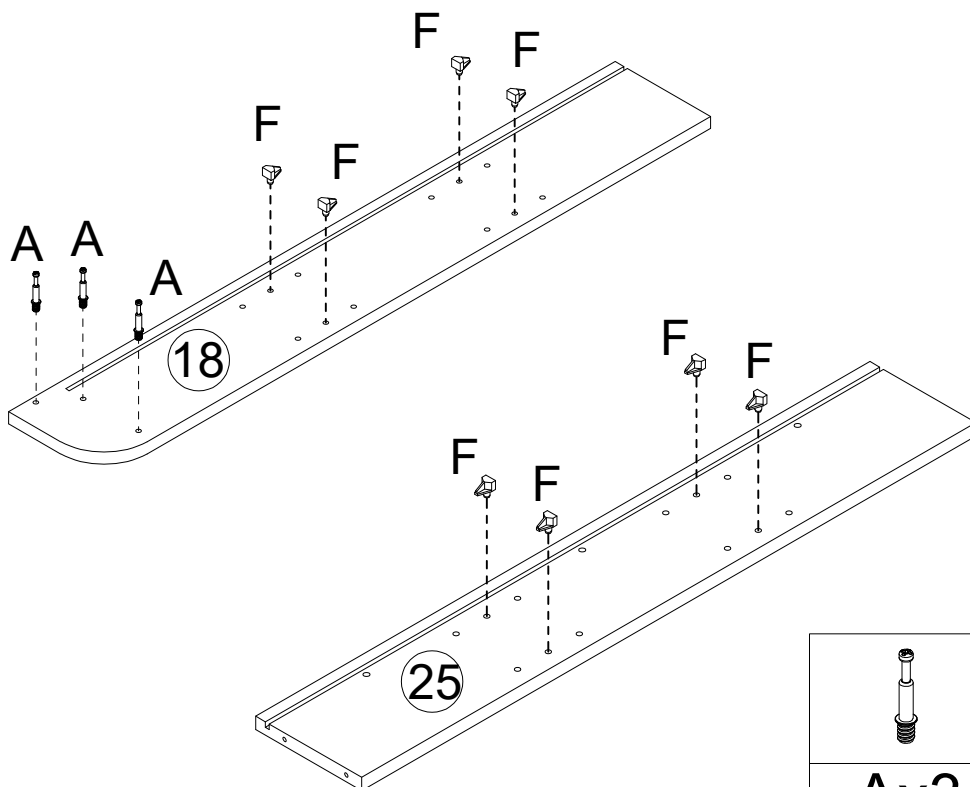
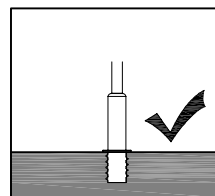
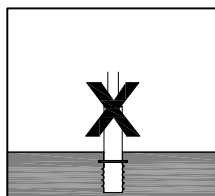
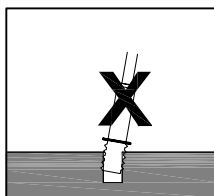
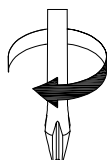

STEP15

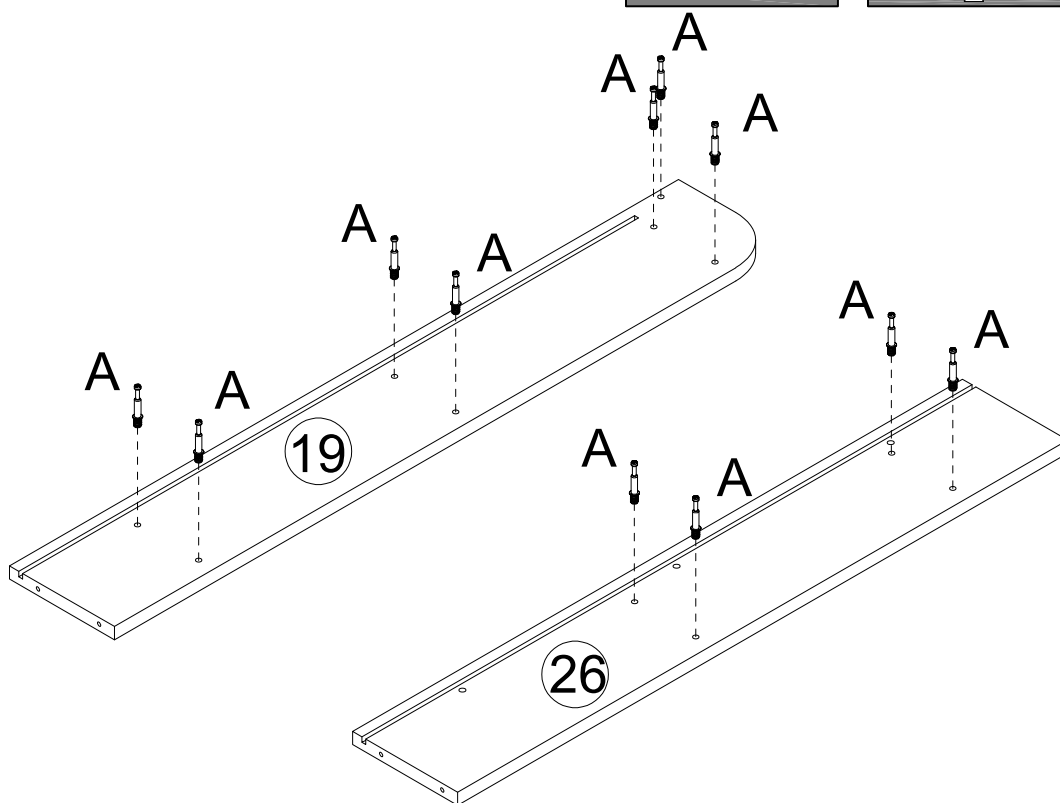
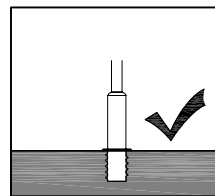
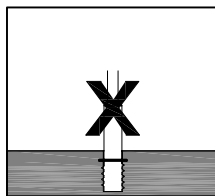
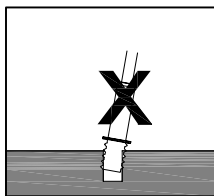
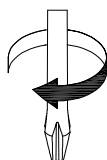

STEP 16

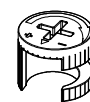
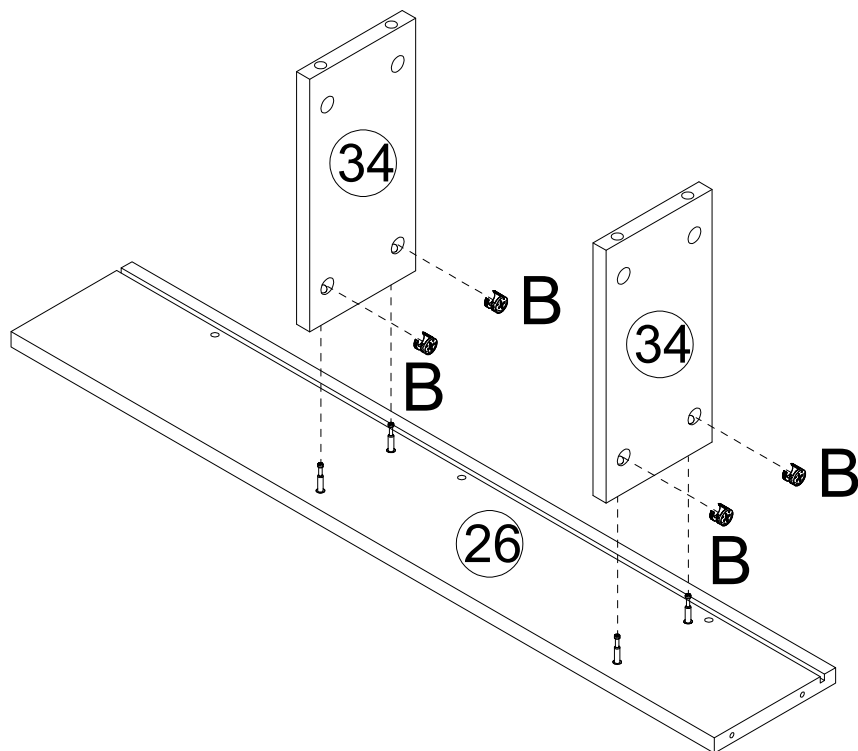
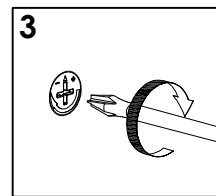
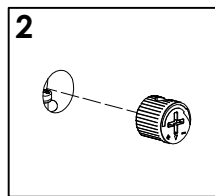
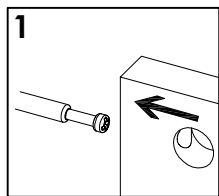
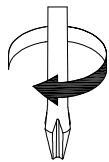

Bx4

STEP 17

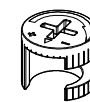
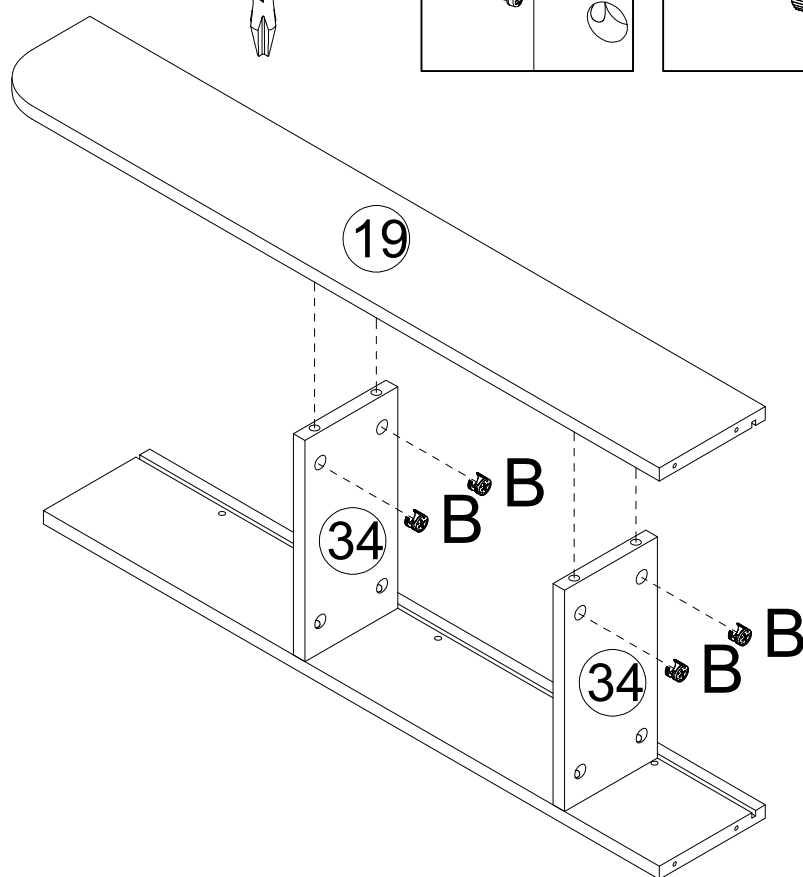
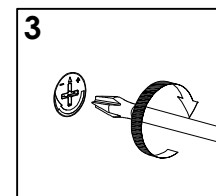
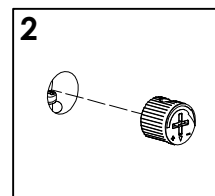
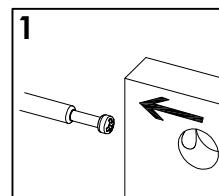
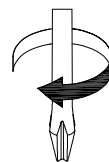

Bx4

STEP18

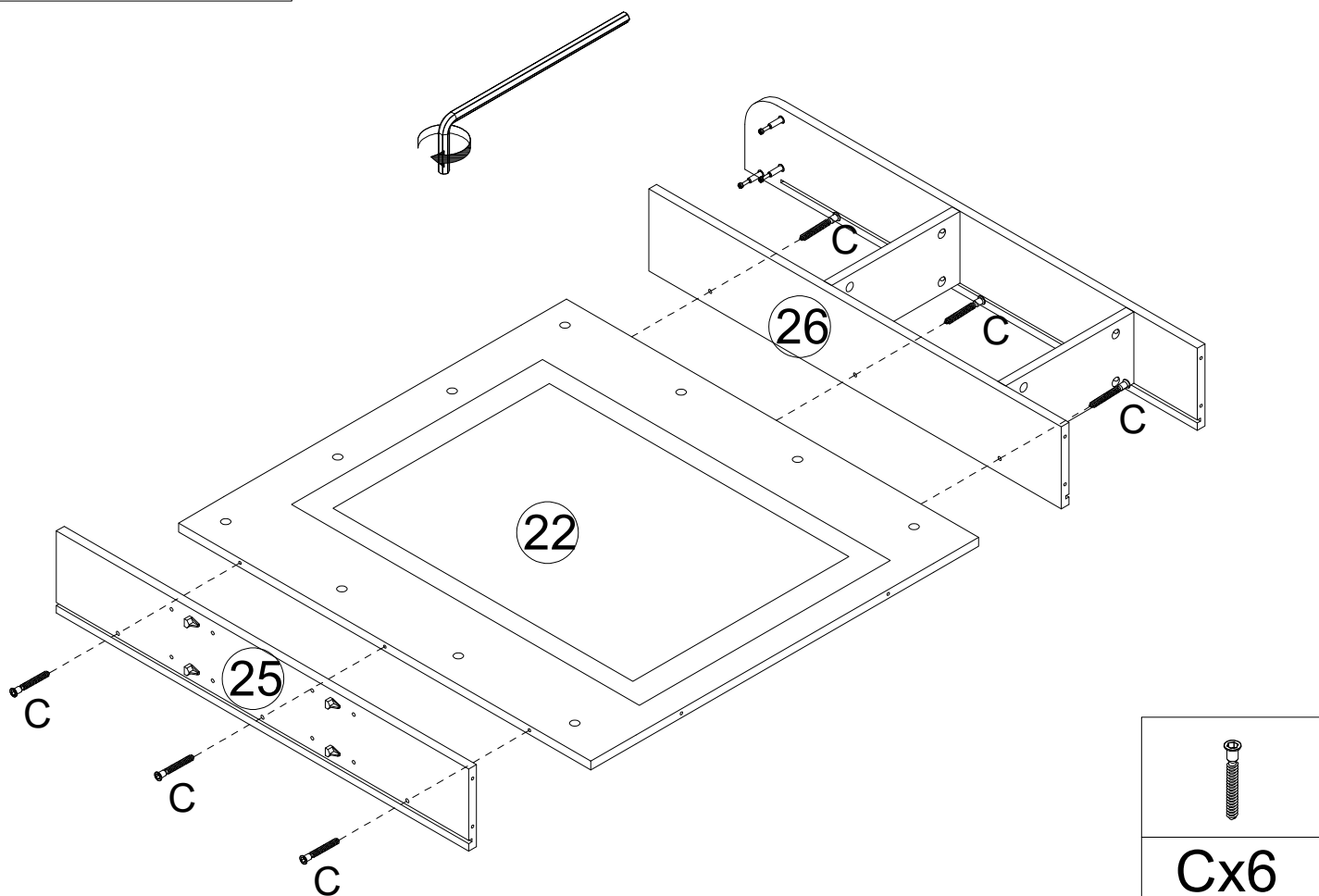

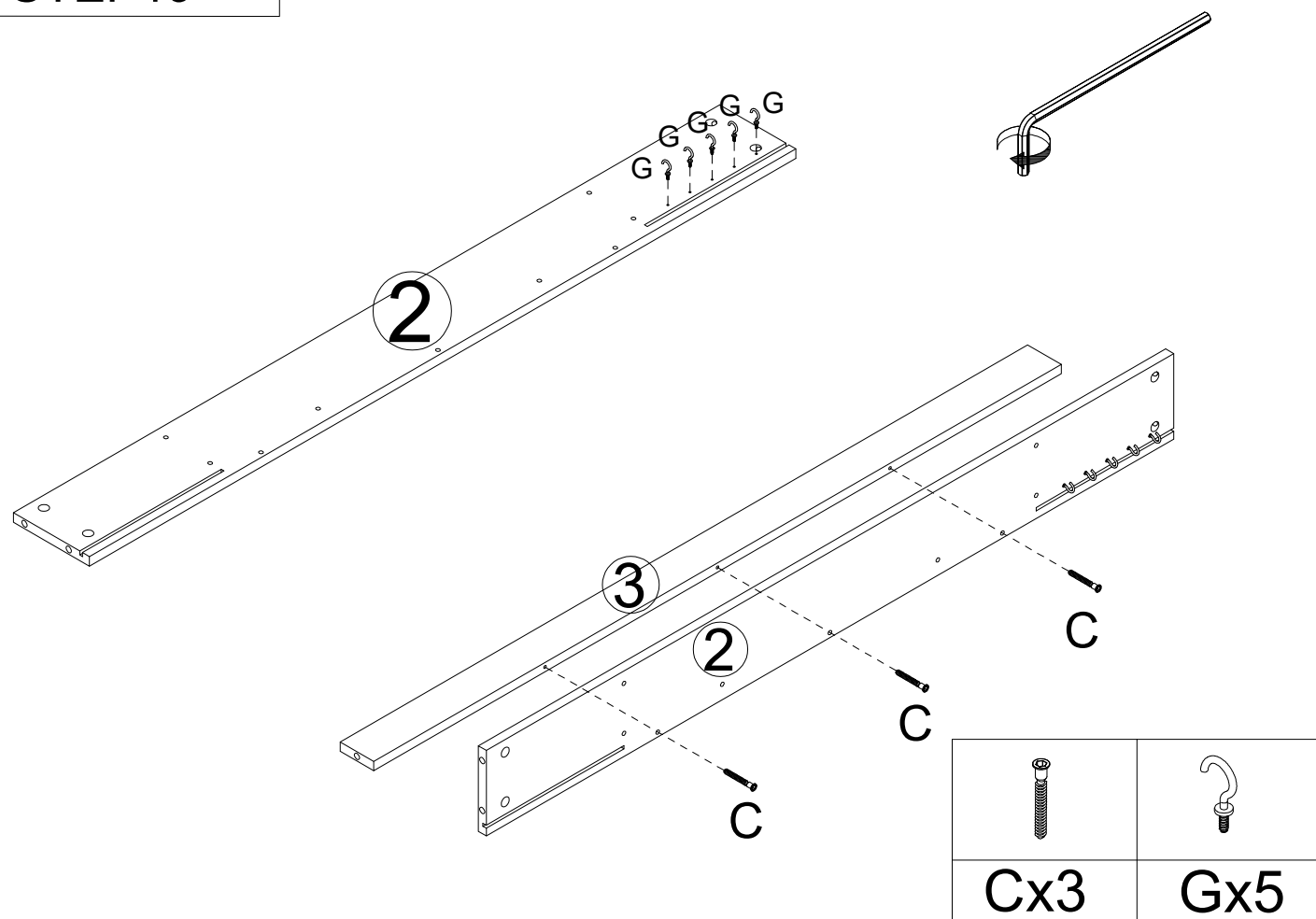

STEP19

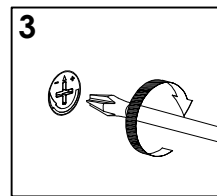
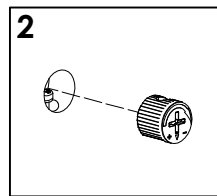
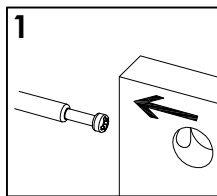
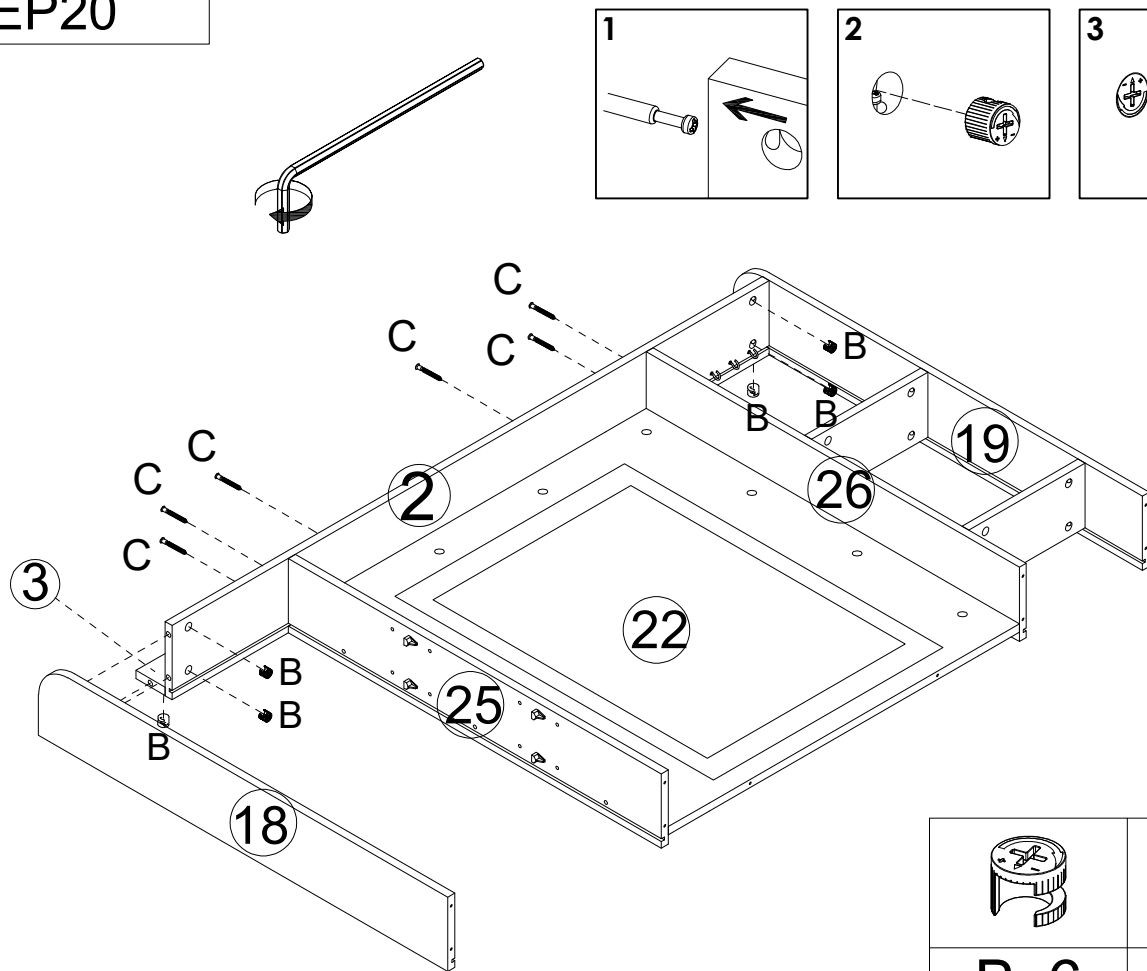

STEP20



	
Bx6	Cx6

STEP21

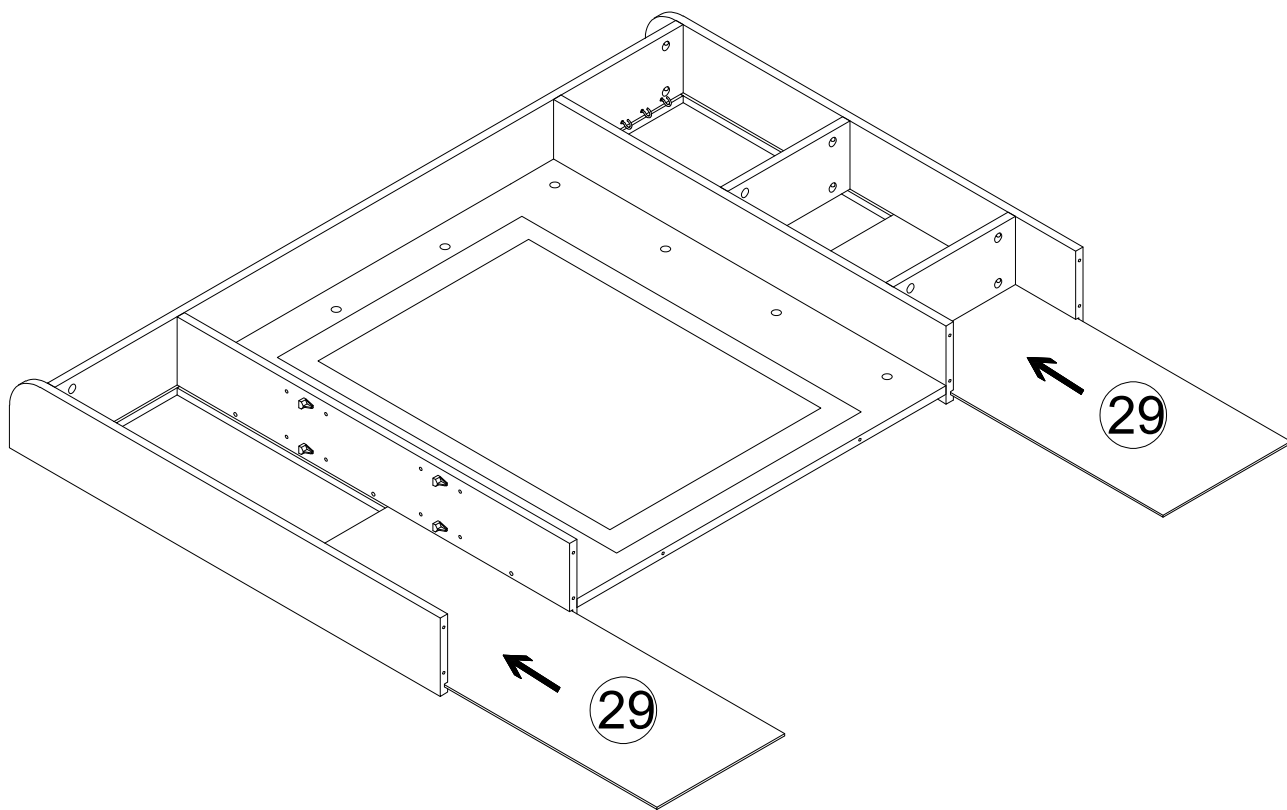

STEP22

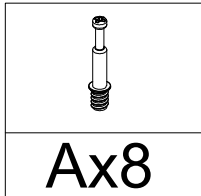
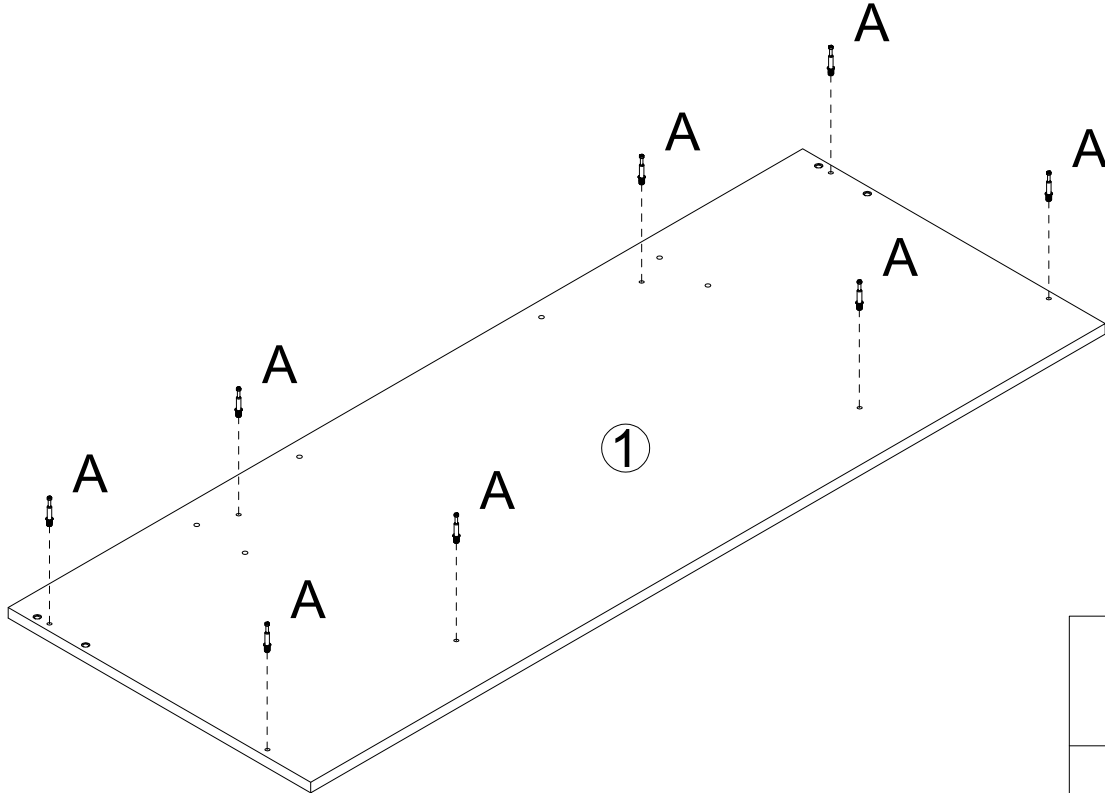
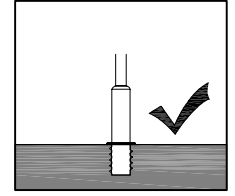
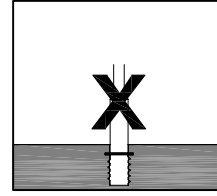
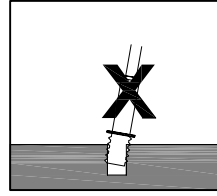
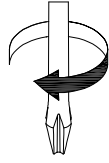

Ax8

STEP23

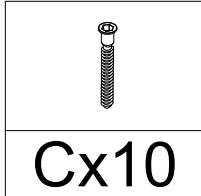
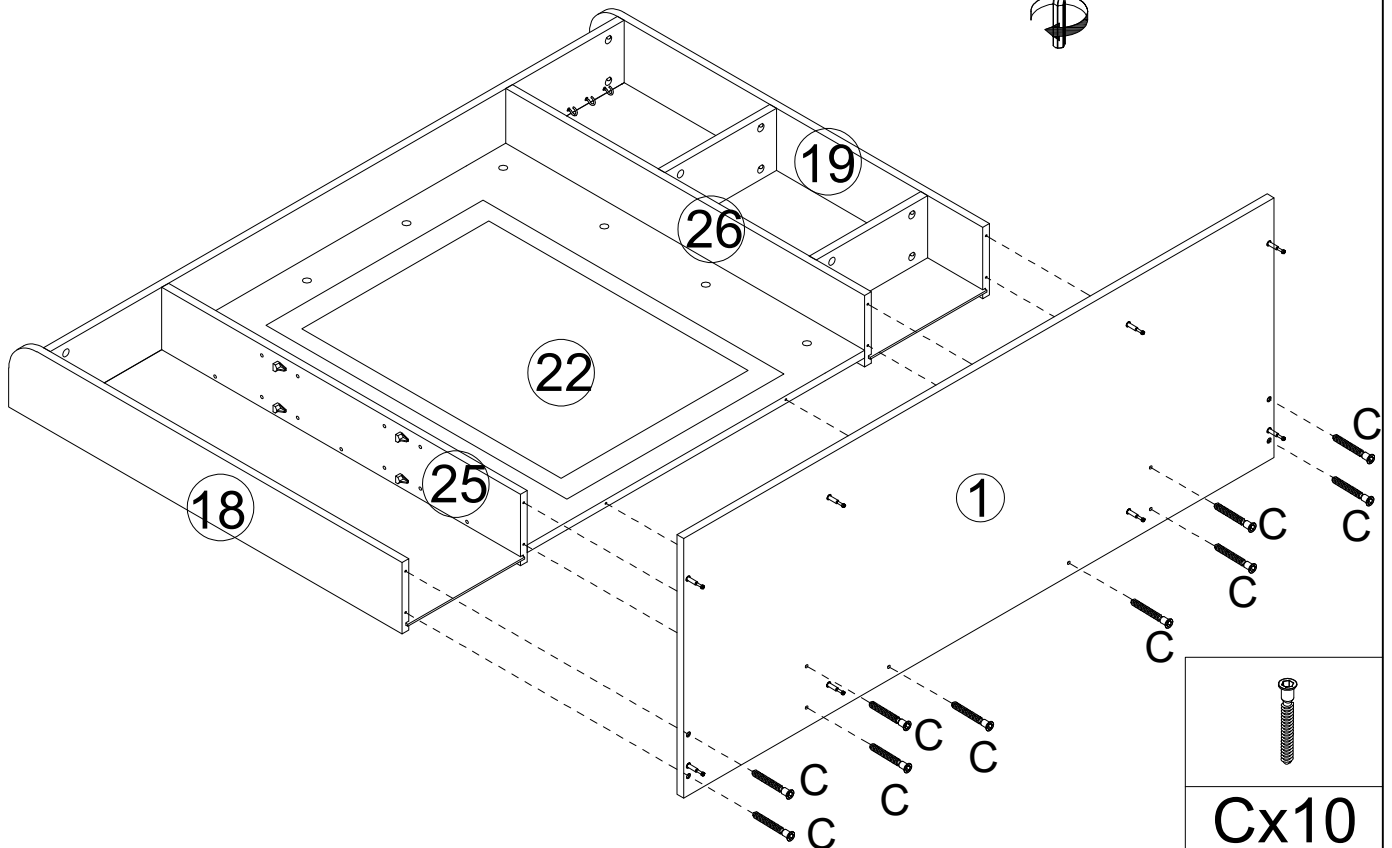
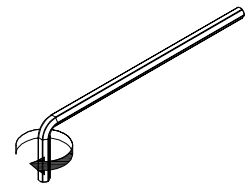

Cx10

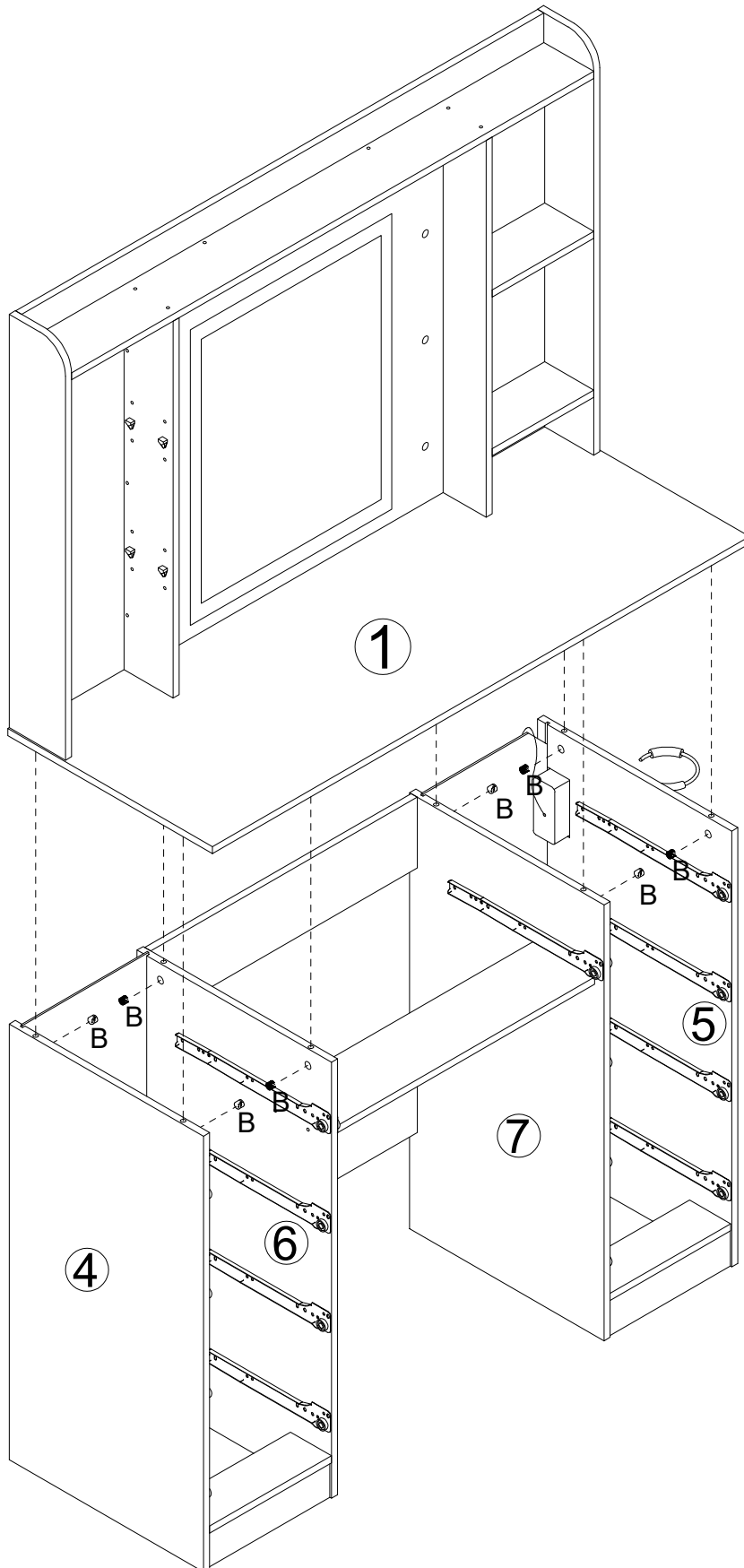
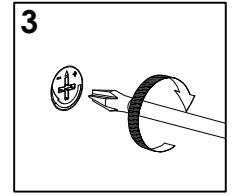
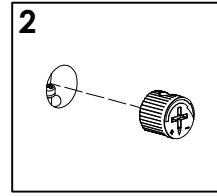
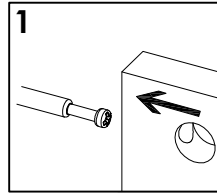
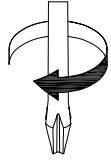

STEP24

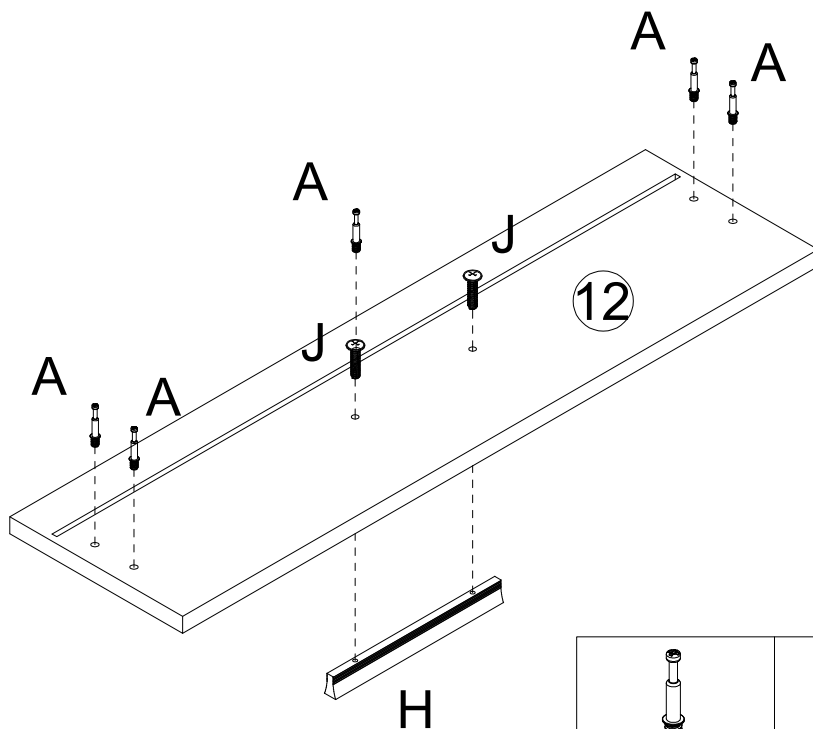
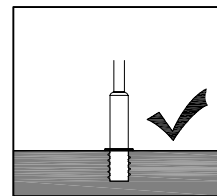
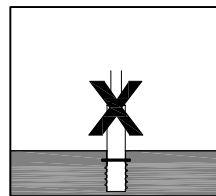
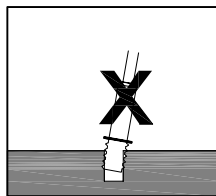
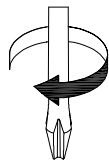

Bx8

STEP25



		
Ax5	Hx1	Jx2

STEP26

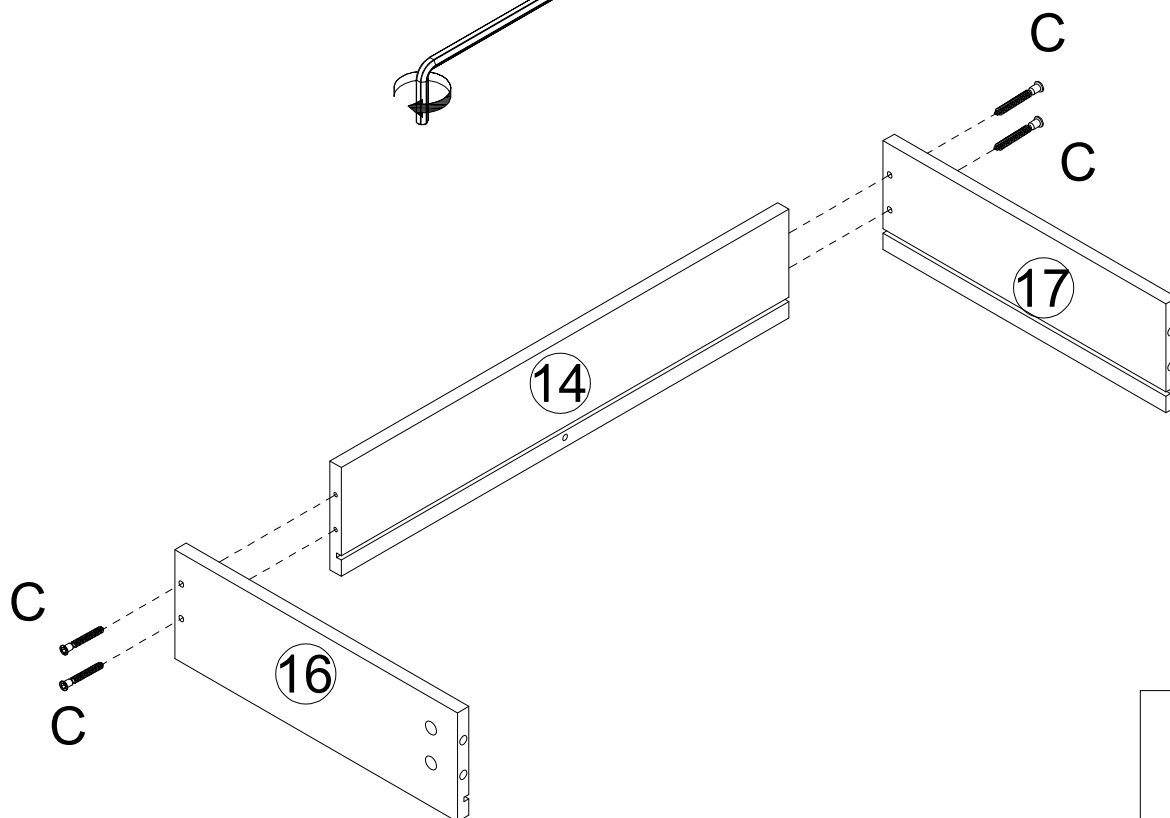
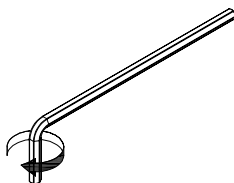

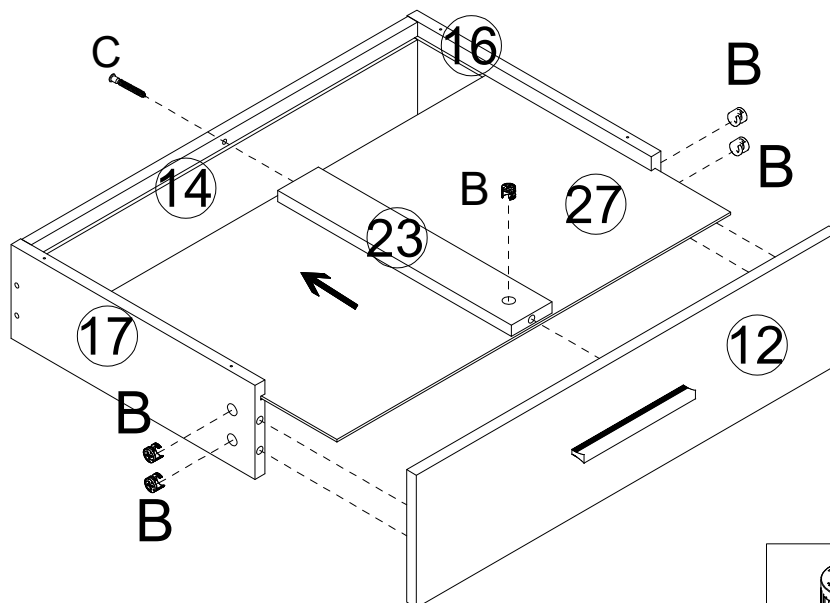
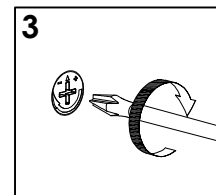
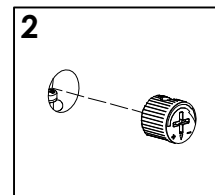
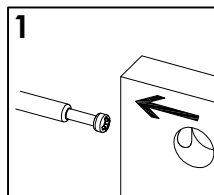
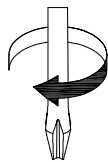

Cx4

STEP27



Bx5	Cx1

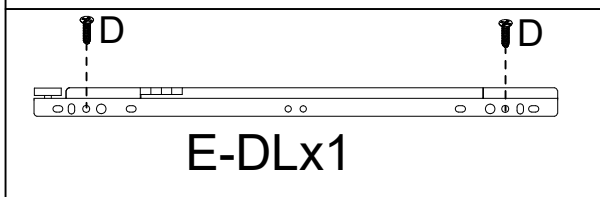
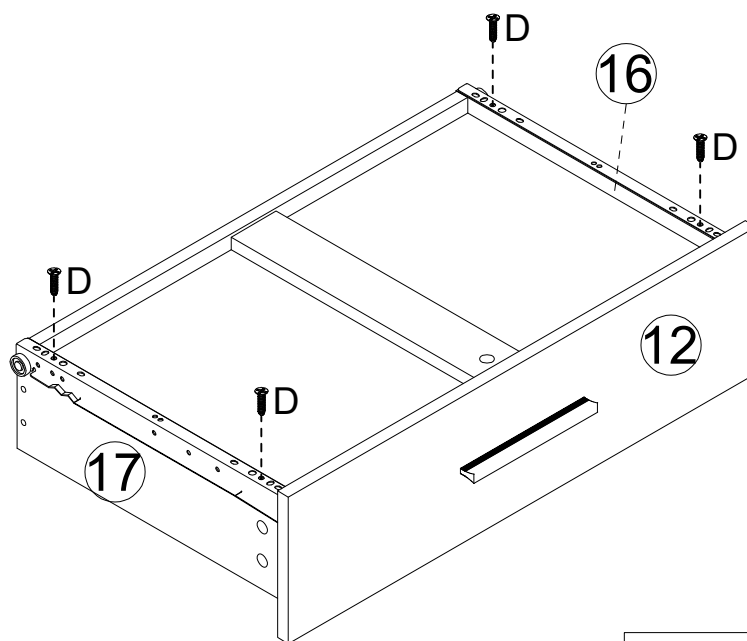
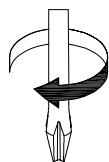

STEP28

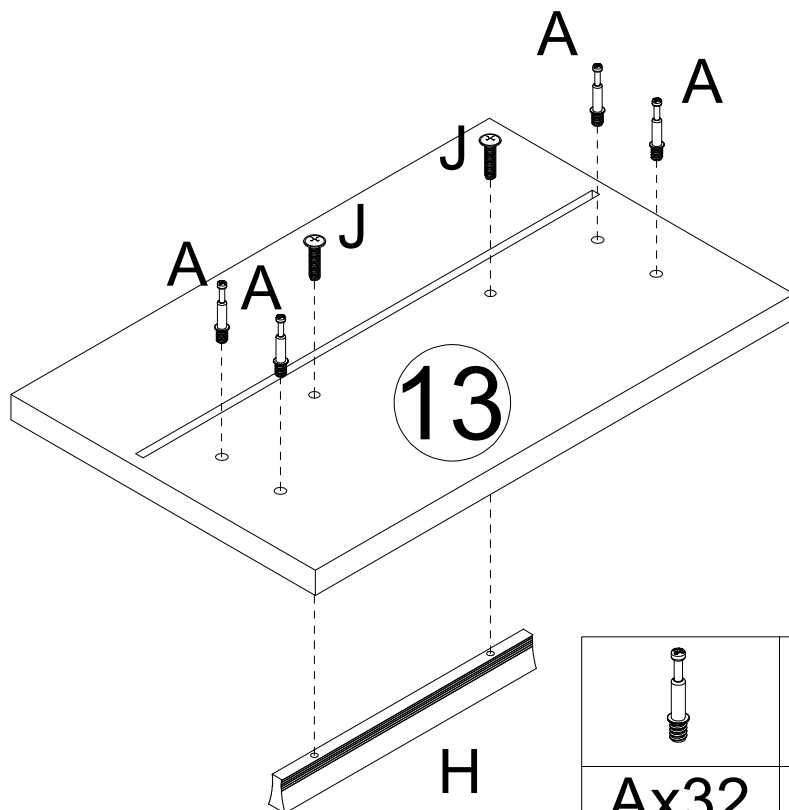
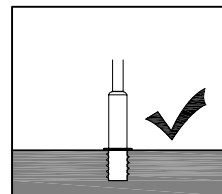
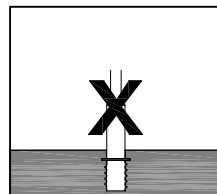
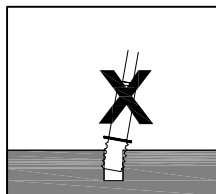
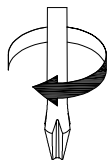

Dx4

STEP29x8



		
Ax32	Hx8	Jx16

STEP30x8

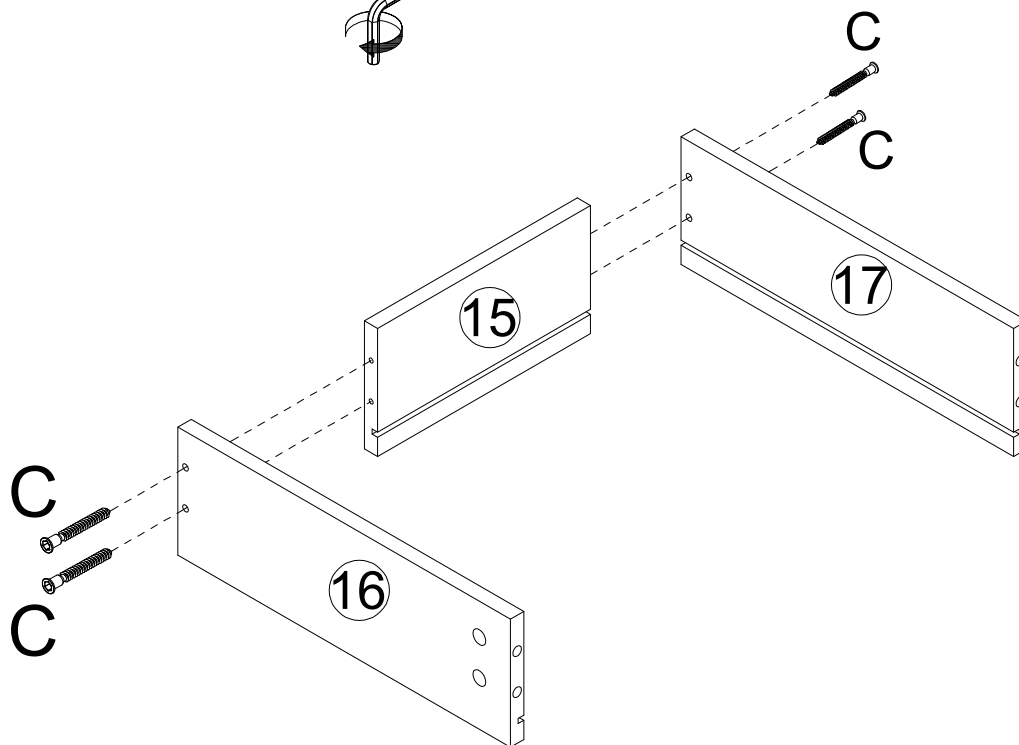
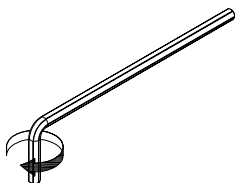

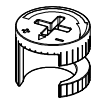
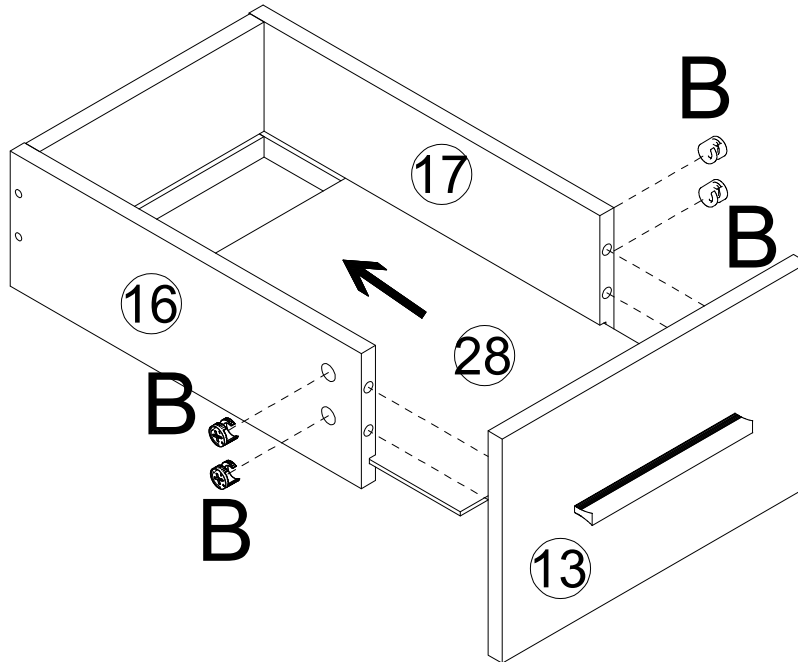
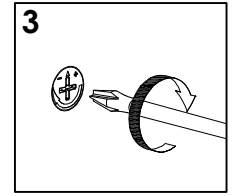
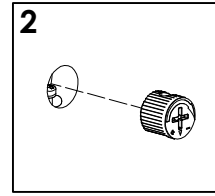
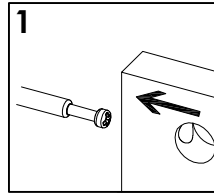
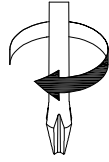

Cx32

STEP31x8

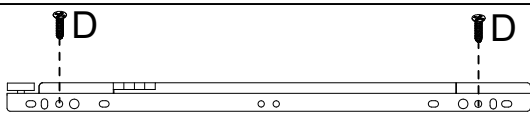
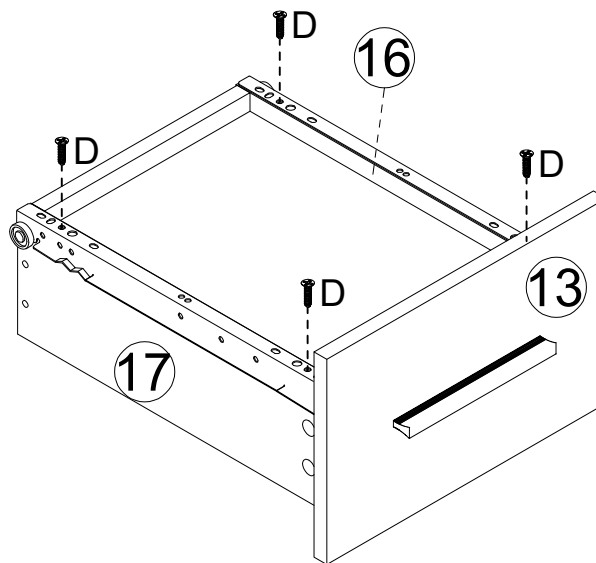
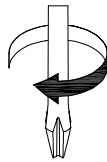

Bx32

STEP32x8



E-DLx8

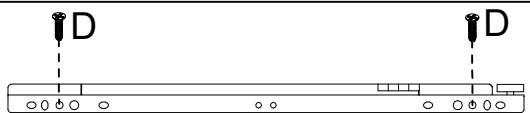

E-DRx8



Dx32

STEP 33

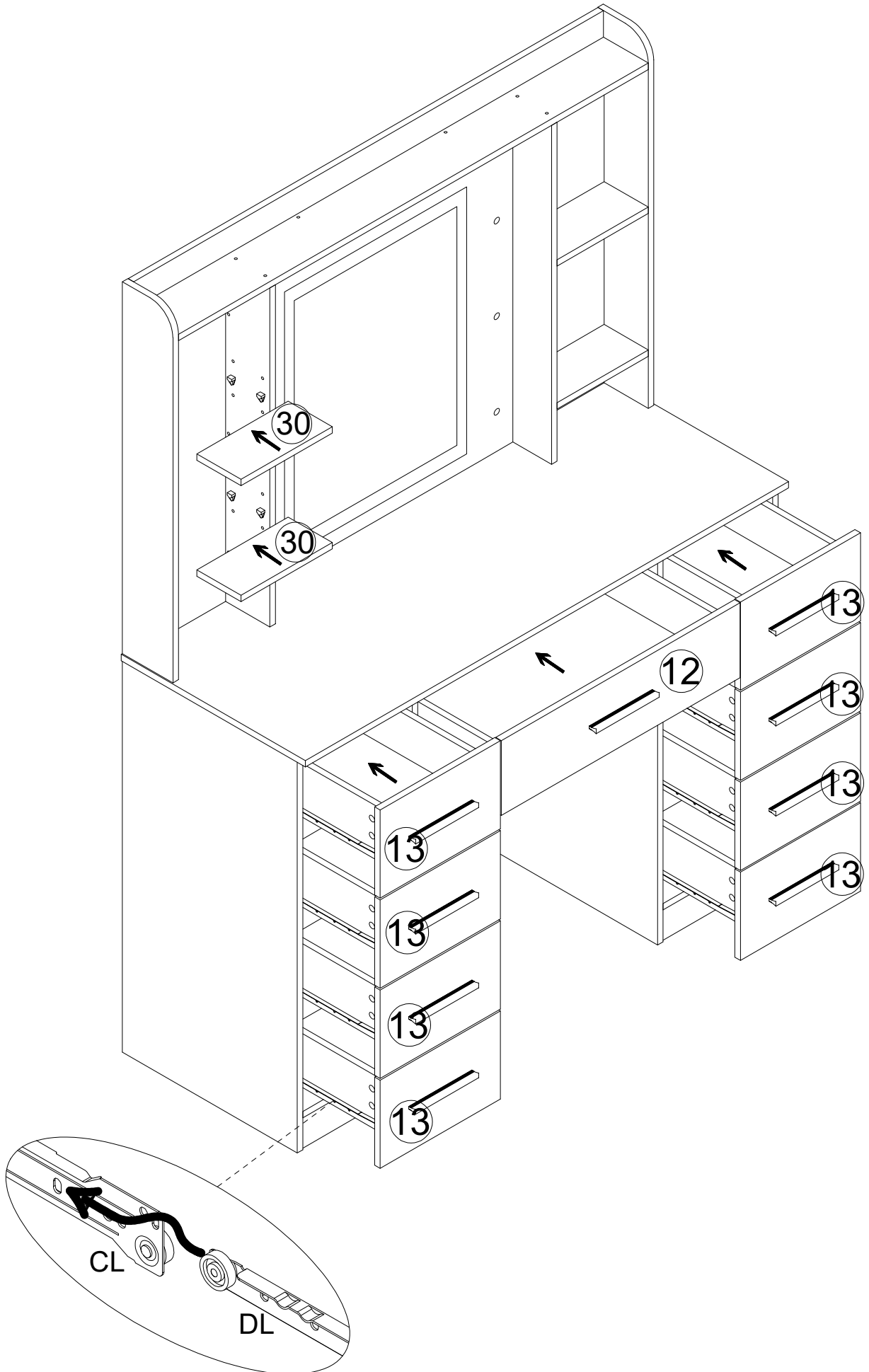

STEP34

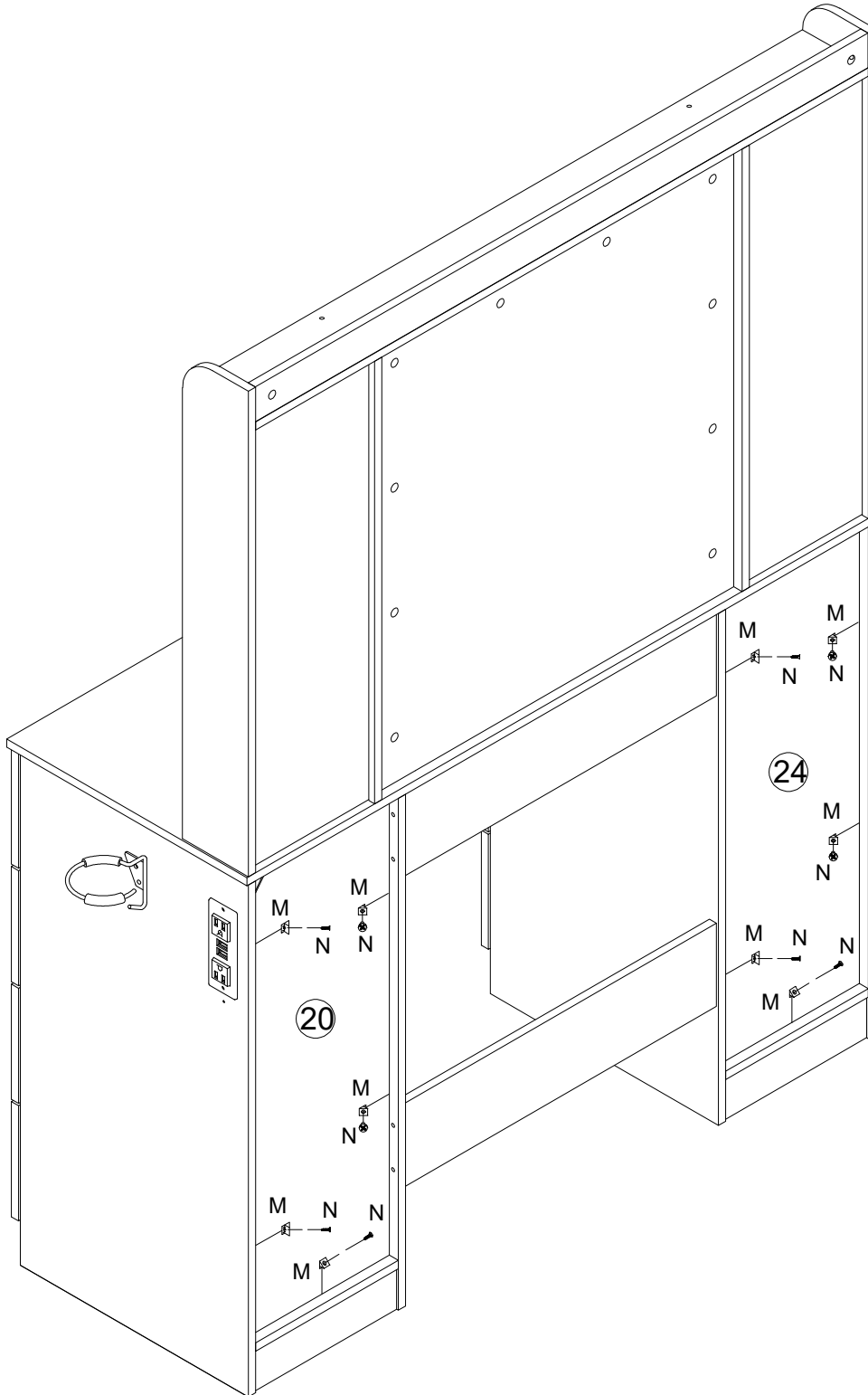
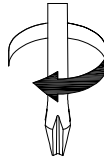

Mx10	Nx10

STEP35

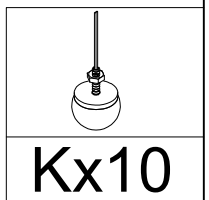
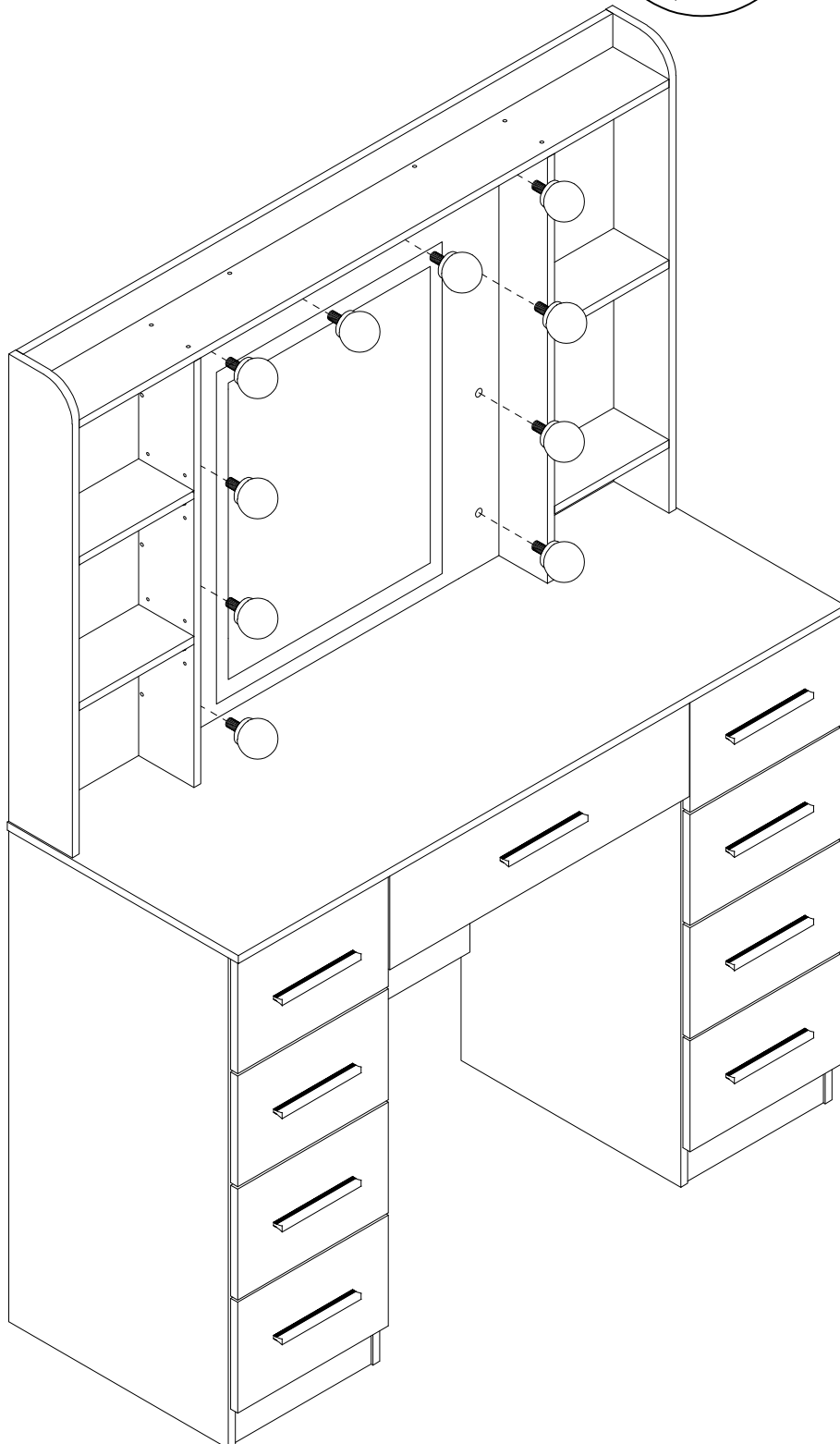
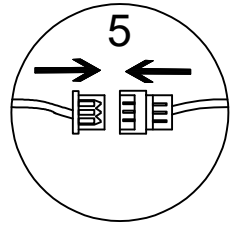
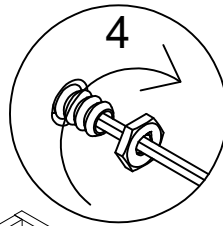
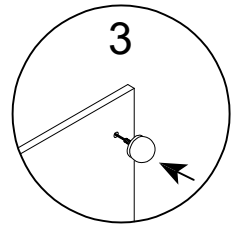
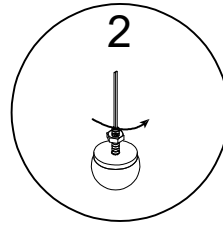
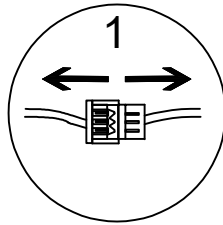

STEP 36

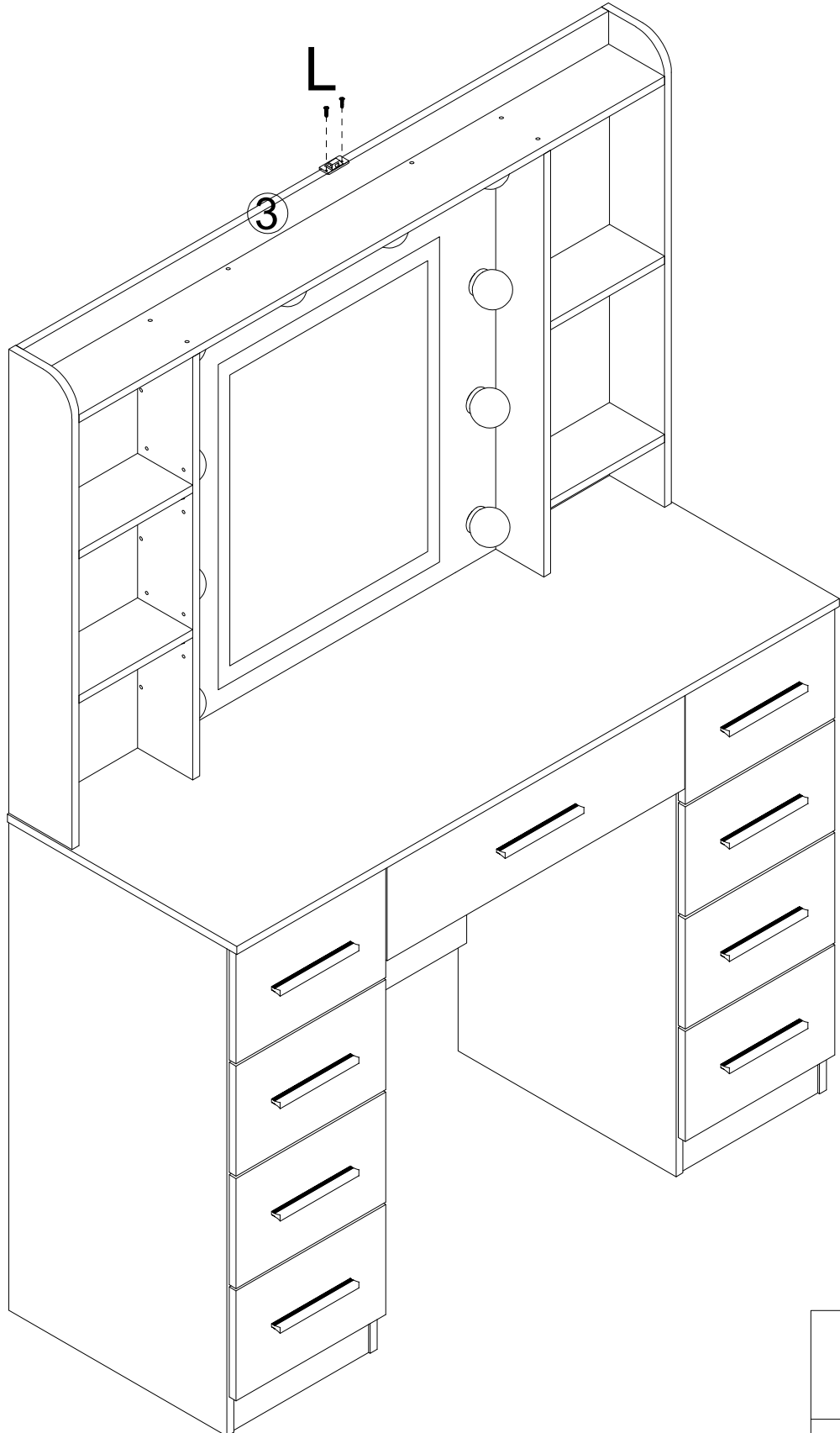
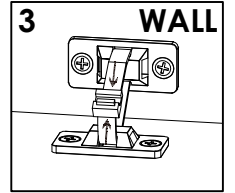
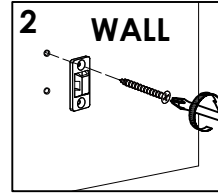
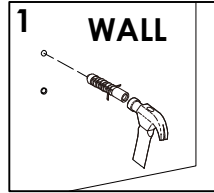
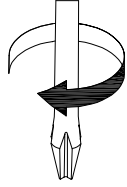

Lx1

STEP37

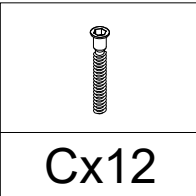
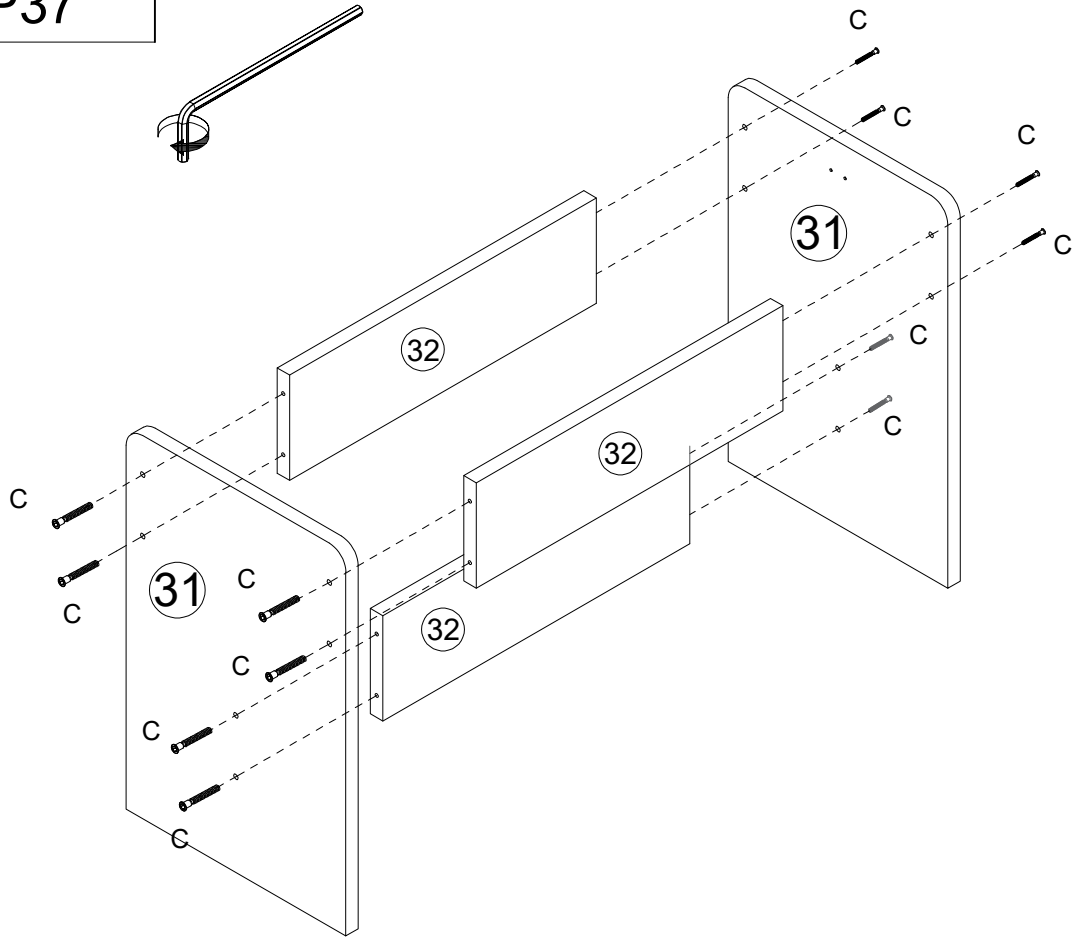

Cx12

STEP38

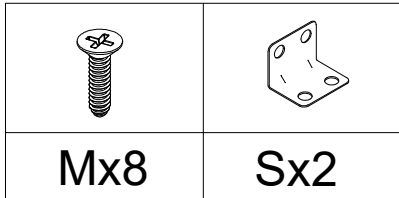
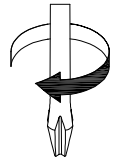
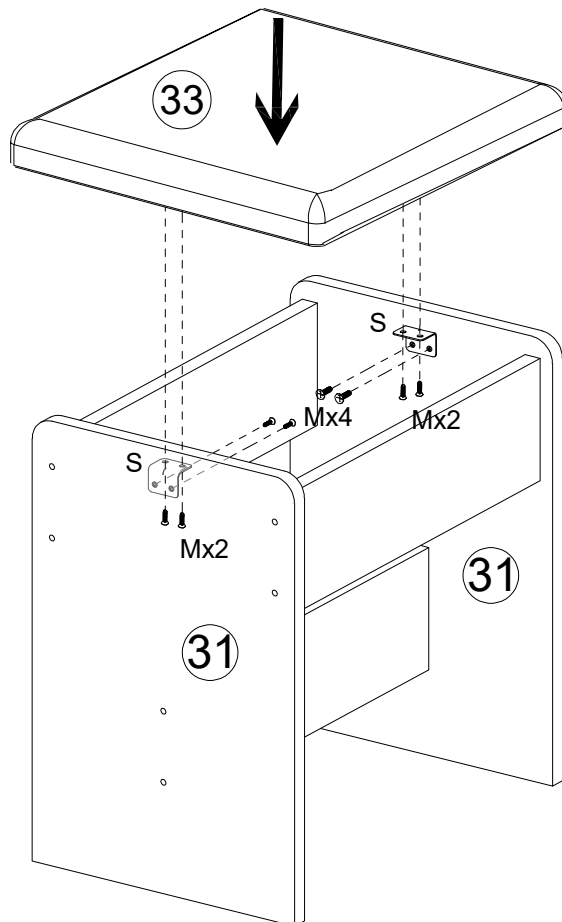

Mx8

Sx2