

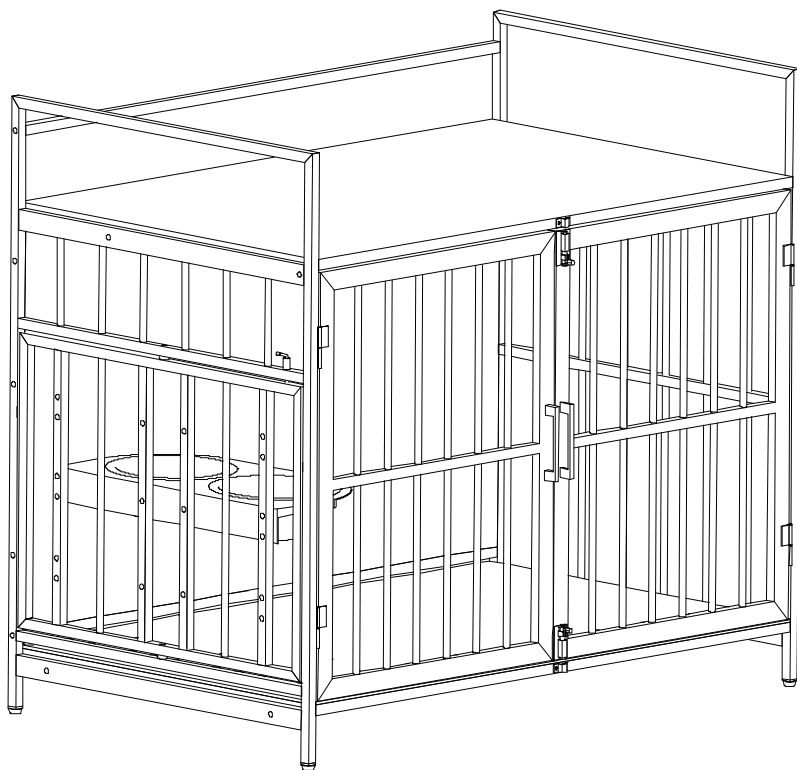











48" Furniture Style Large Dog Crate Instruction Manual





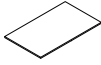











TEL: **(800)209.3199** (MON-FRI 9:00am-5:00pm Eastern Time)
Email: elp@Evertinport.com

PARTS LIST

- Carefully remove all the parts from the carton and place them individually on a soft cloth to prevent scratches or other damage.
- Carefully and strictly follow these assembly&installation instructions to ensure a completed product as designed.
- Do not tighten all the screws until each part is properly assembled.



Number	Parts	Quantity
A		1PC
B		1PC
C		1PC
D		1PC
E		1PC
F		5PCS
G		1PC
H		1PC
I		1PC
J		1PC
K		2PCS
L		1PCS

Number	Parts	Quantity
①	 M5*45	9PCS
②	 M6*30	12PCS
③	 M6*25	11PCS
④	 M6*22	6PCS
⑤	 M6	6PCS
⑥	 M4	1PCS
⑦	 (10-10)	1PCS
⑧	 Hold hands	2PCS
⑨	 M4*25	4PCS
⑩	 Philips head screwdriver	1PCS
⑪	 The u-button	2PCS
⑫	 M4*20	6PCS
⑬	 Plastic parts	1PCS
⑭	 Bumper stickers	1PCS

DOG CRATE ASSEMBLY

STEP 1



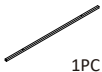
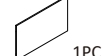

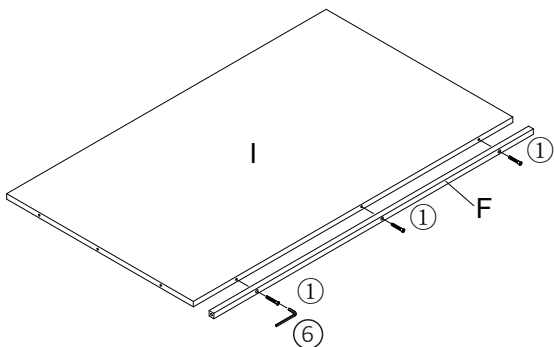

Use tools (1) (6) to screw the two (F) tubes on either side of the backing board (I)

Required Tools	①	⑥
		
	3PCS	1PC
	F	 1PC
I	 1PC	



STEP 2

Use tools (1)(6) to screw (A) iron frame to (I) board, and then use (2)(6) to screw (A) iron frame to (F) square tube and (E) square tube



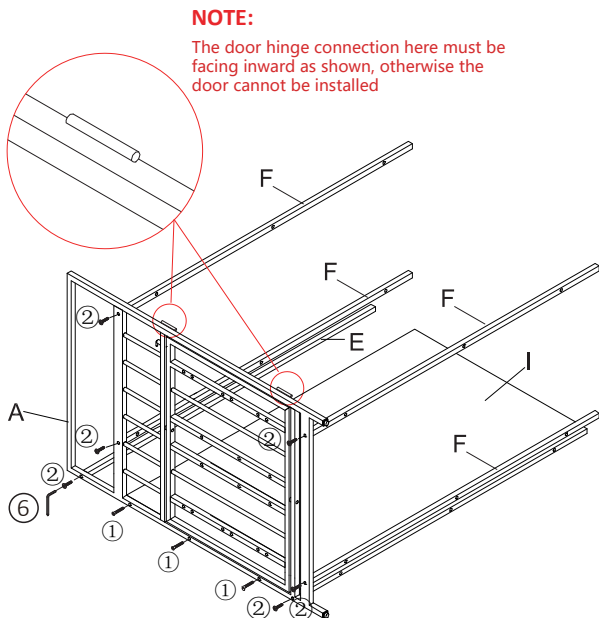

Required Tools	①	②	⑥
			
	3PCS	6PCS	1PCS
	A		1PC
	E		1PC
F		4PCS	



☆ Please pay attention to the hole position in the picture and screw it in vertically

STEP 3



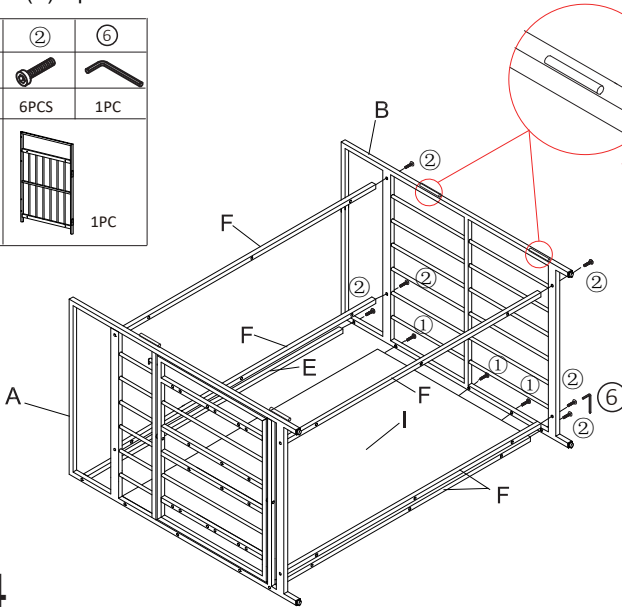

Use tools (1) (6) to screw (B) iron frame to (I) board, and then use (2) (6) to screw (B) iron frame to (F) square tube and (E) square tube.

Required Tools	①	②	⑥
			
	3PCS	6PCS	1PC
	B		1PC



STEP 4

Use tools (3)(6) to screw (H) bottom board to the bottom (F) square tube and (G) top board to the top (F) square tube and screw (L) into the corresponding (F) tube hole

Required Tools	③	⑥
		
	11PCS	1PC
	G	 1PC
	H	 1PC
	L	 1PC

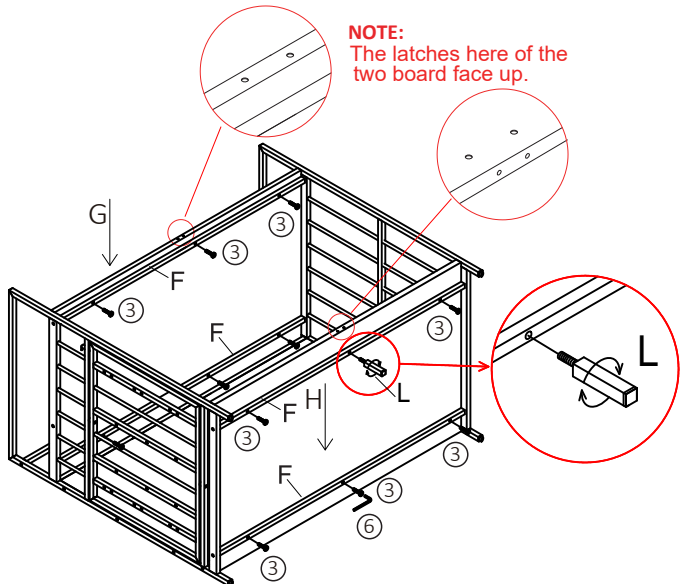

☆ Please pay attention to the hole position in the picture and screw it in vertically

STEP 5

Use tools (4)(5)(6)(7) to screw the dog feeding tray (J) to the (A) iron frame, then use (10)(12) to screw (13) on the bottom board

You can measure the height of the dog according to the method shown in the figure and then select the corresponding installation height of the dog feeding tray

1. Measure your dog from the floor to the highest point of their shoulder blades.
2. Match your dog's measurement to the feeder height on the chart.

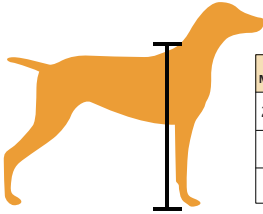

Dog Measurement	Feeder Height
21" & Taller	20"
15" - 20"	14"
10" - 14"	8"

Required Tools	(4)	(5)	(6)	(7)	(10)	J
	6PCS	6PCS	1PC	1PC	1PC	1PC
	(12)	(13)				
	2PCS	1PC				

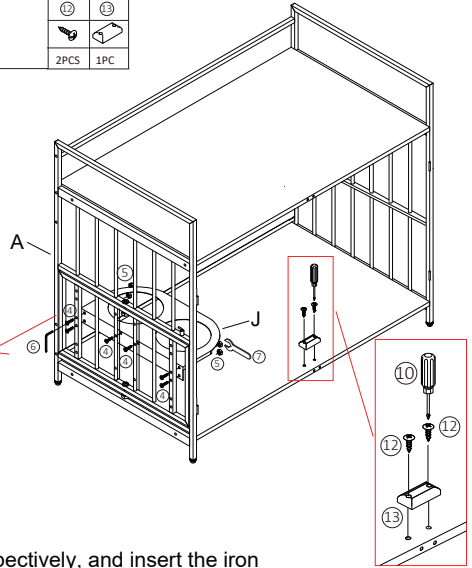

NOTE:

The three pairs of holes are respectively 8 inches, 14 inches and 20 inches from the height of the bottom board

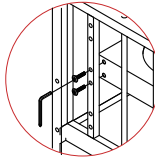

STEP 6



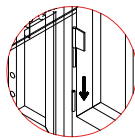
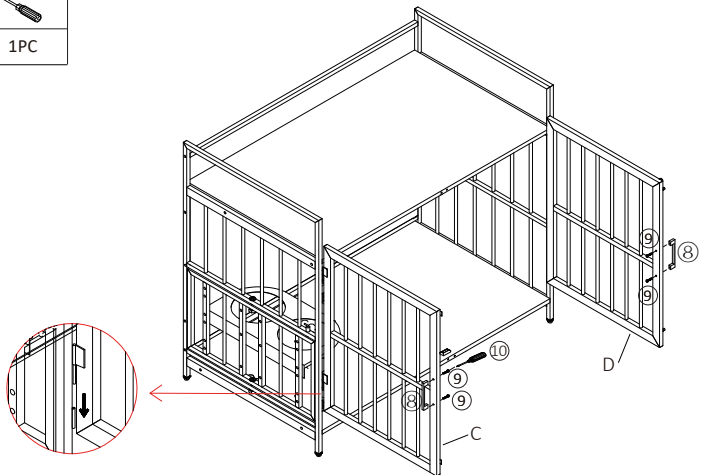

Take out the left and right iron doors (C) and (D) respectively, and insert the iron door hinges from the top according to the method shown in the figure, then use tools (8)(9)(10) to tighten the door handle on the door.

Required Tools	(8)	(9)	(10)
	2PCS	4PCS	1PC
	C	D	
	1PC	1PC	



STEP 7

Use (10) (12) to screw (11) on the guide holes of the top plate and bottom plate respectively then place the dog bowl (K) into the feeding tray.

	K	(10)	(11)
Required Tools			
	2PCS	1PC	2PCS
	(12)		
			
	4PCS		

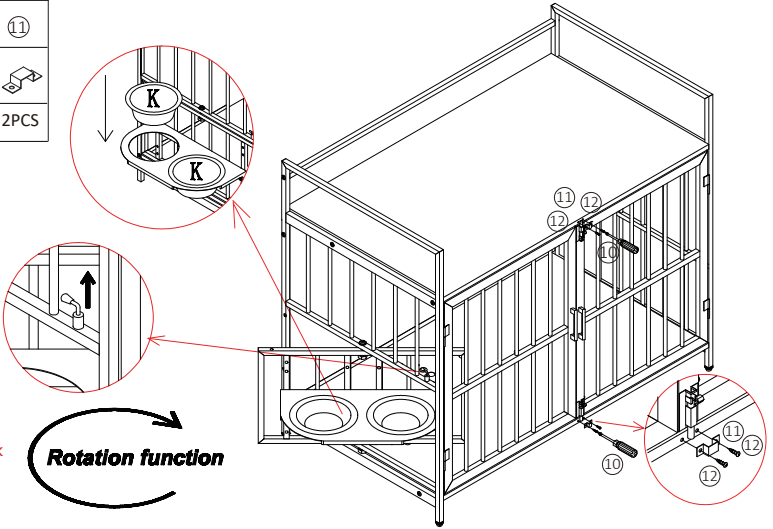

NOTE:

Pull the latch up to open the dog feeding tray that can rotate freely 360 degrees, align the latch with the hole on the tray and insert it to lock

☆ Please pay attention to the hole position in the picture and screw it in vertically

STEP 8

If your dog likes to shake the door, you want the deadbolt to be tighter and the door does not shake, you can use this anti-collision sticker (14) to stick it on the position shown in the picture, but it may increase the difficulty of opening and closing the lock, please choose by yourself .

Required Tools	(14)	
		
	1PCS	

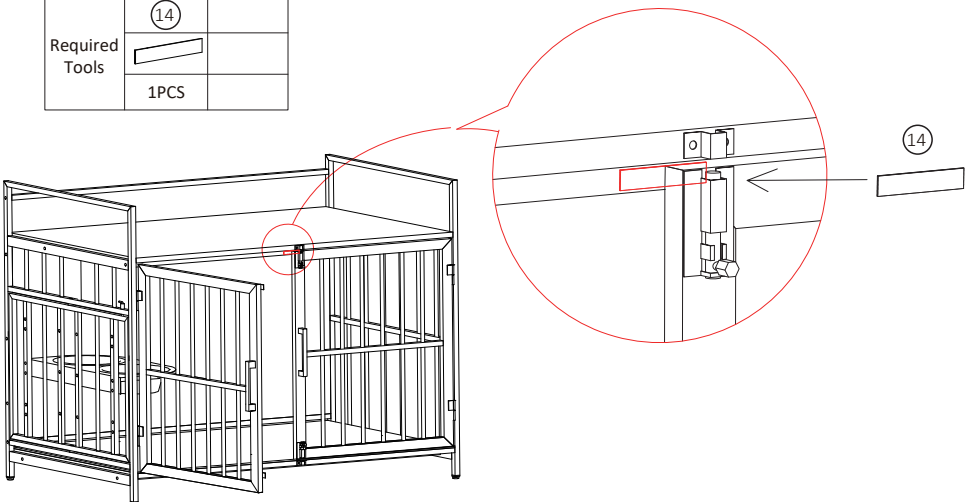

AFTER-SALES SERVICE CARD

We sincerely thank you for trusting our service and our products, and may this product add enrichment to your home. We guarantee that the product has undergone strict quality inspection and meticulous packaging. If you encounter any issue regarding either shipping or the product, please feel free to contact us at any time. We'd be more than happy to serve you wholeheartedly.

Yours Sincerely

- Please avoid harsh, corrosive and abrasive cleaners.
- Keep dry and avoid damp environments.

***Customer Service:(800)209.3199(MON-FRI 9:00am-5:00pm
Eastern Time) or contact help@EverthingSupport.com***

Address: 3005 Breckinridge Blvd, Suite 200, Duluth, GA 30096

If you have any questions or concerns please feel free to contact us. We're committed to providing our customers with the quality service.