

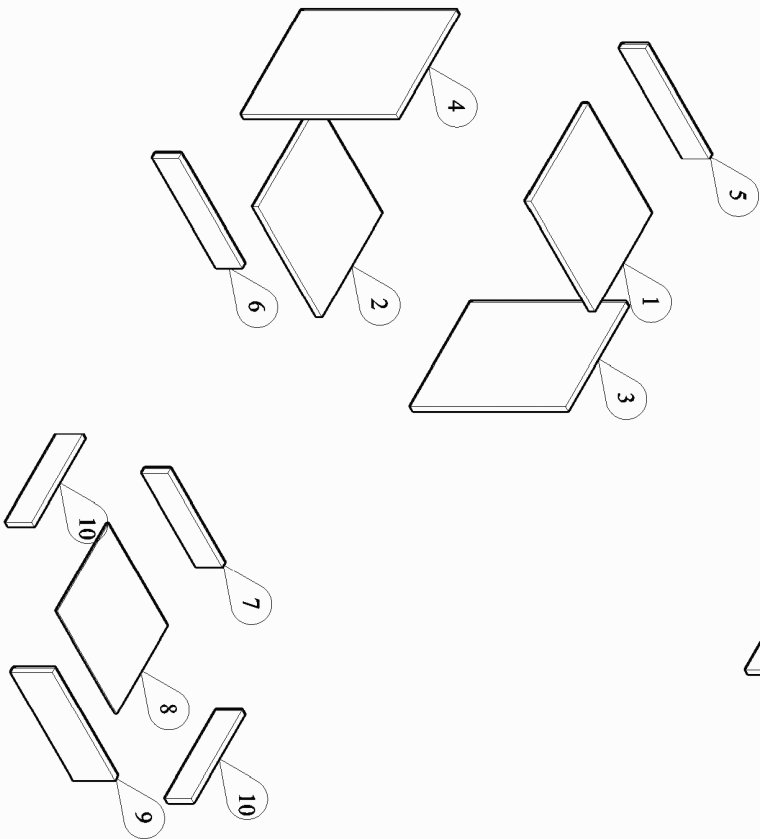

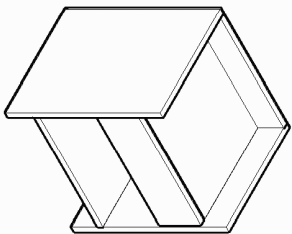









PANEL POSITION

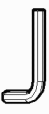

| | ACCESSORIES | QUANTITY |
|---|--|-----------------|
| A |  DRAWER SLIDE 12 "  SCREW M3.5 x 12MM | 1 SET 12 PCS |
| B |  MINIFIX M5X24MM | 8 PCS |
| C |  CASING | 8 PCS |
| D |  WOOD DOWEL M8X30MM | 12 PCS |
| E |  WHITE PIN LEG | 4 PCS |
| F |  SCREW M4x38MM | 8 PCS |
| G |  POWER PIN | 10 PCS |
| H |  ALLEN KEY | 1 PC |

| | | | |
|---|---|---|---|
|  |  |  |  |
| CHEMICAL | HANDLE WITH CARE | KEEP DRY | HARD SURFACE |

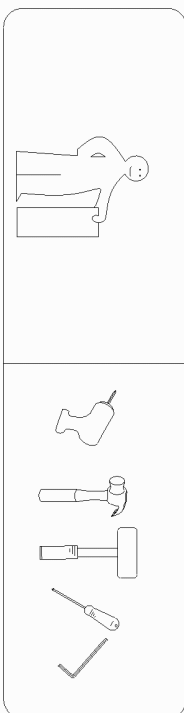

START ASSEMBLY

STEP 1

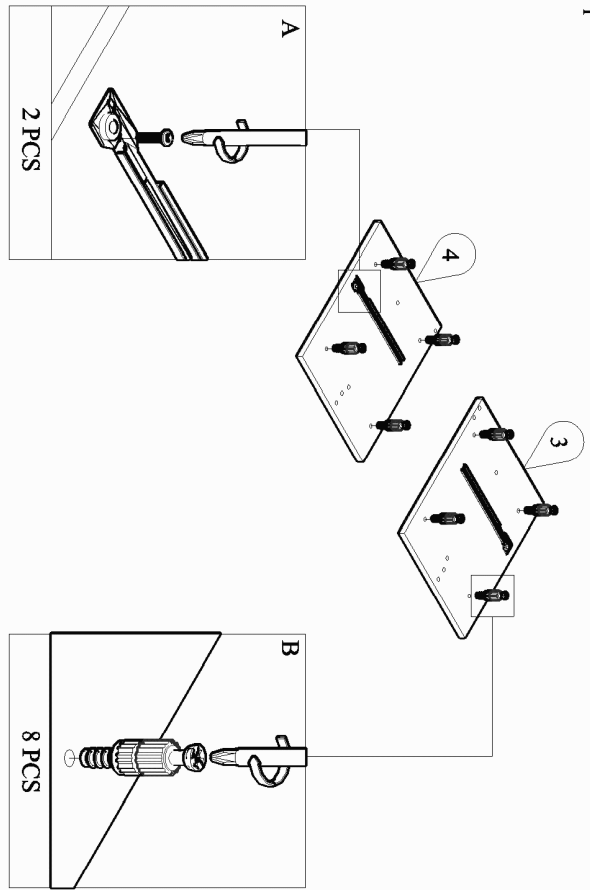

STEP 2

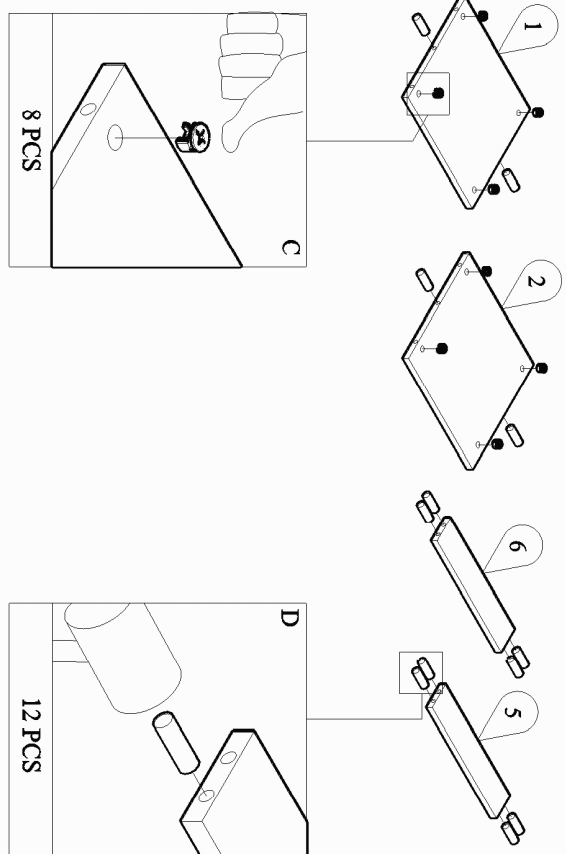

STEP 3

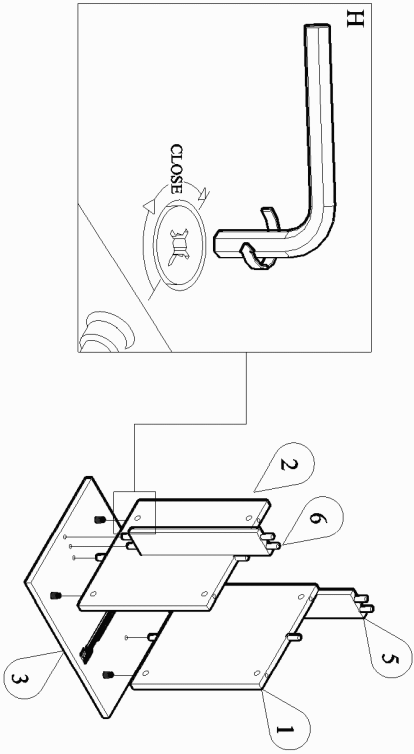

STEP 4

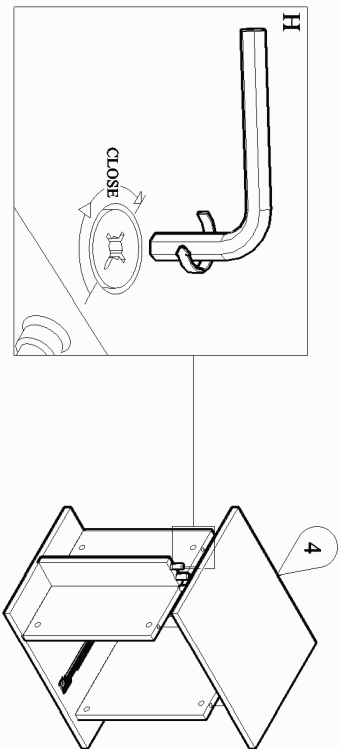

STEP 5

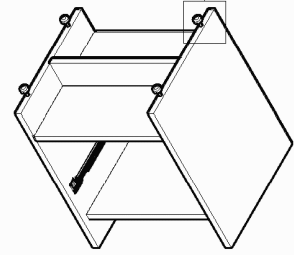
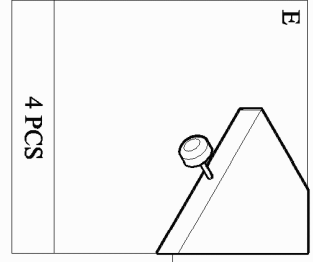

STEP 6

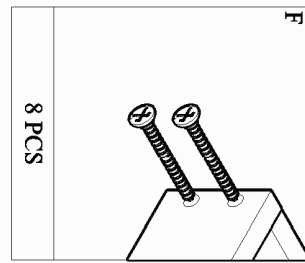
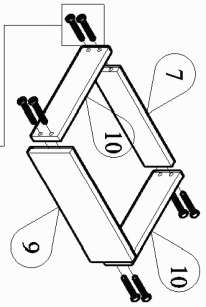

STEP 7

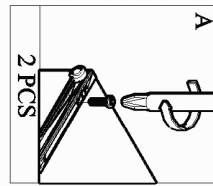
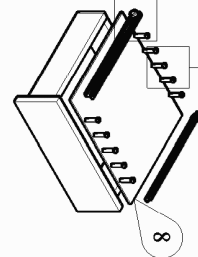
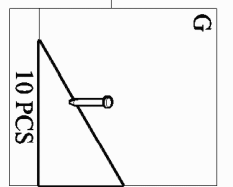

COMPLETED

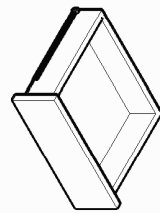

STEP 8

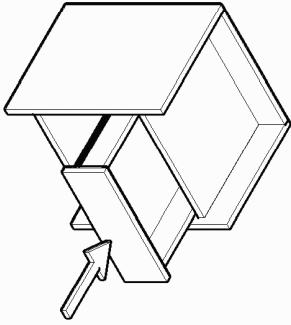

COMPLETED

