

ENJOY LIFE · SHARE HAPPINESS

INSTRUCTION MANUAL

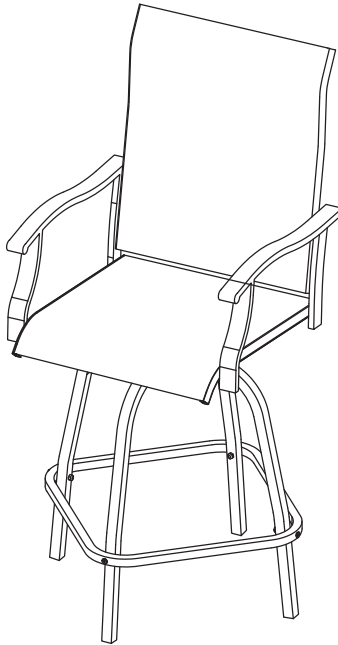

Iron Swivel Bar Stool

INTRODUCTION



Thanks for purchasing and trusting with your home decorating plans. This product is a piece of furniture designed.





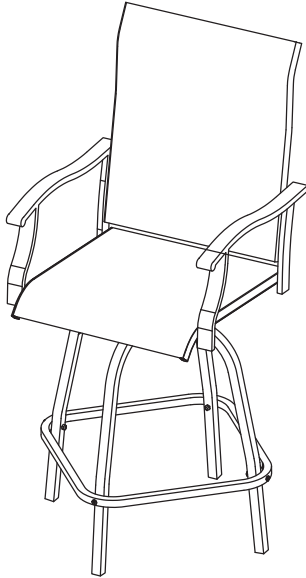
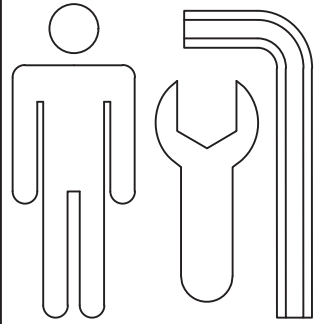
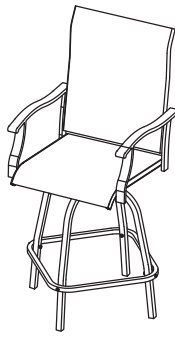

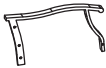





We are committed to R&D and innovation and creating the most exquisite and diverse outdoor series.

After unpacking and before every use, check whether the item shows any damage. In addition, check that you have all parts and hardware before assembly. If there is any damage, please do not use it and call customer service. If you do not have all the parts lists, have your dealer contact us and we will send them to you immediately.

This item of furniture is intended for indoor and outdoor use. Please take time to read and follow the instructions below. Then, use this item as described in this operating manual. We accept no liability for damage caused by improper use.



Part Number	Images and Sizes	Qty.
A		1
B		1
C		1
D		1

N		4	J		12	E		1
O	 M6*35	4	K	 M6*30	8	F		1
U		1	L		8	G		1
V		1	M	 M6*55	4	I		16

ASSEMBLY INSTRUCTIONS



CAVEAT

Note: Please only tighten any bolt once all bolts are placed correctly. If you tighten one bolt, it may cause other bolts to get out of position.

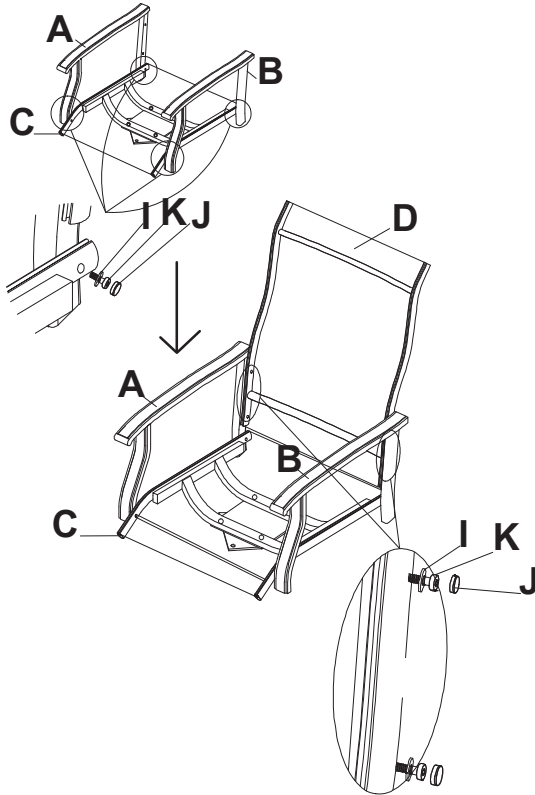

STEP 1

Attach the right armrest (A) and the left armrest (B) to the seat frame (C) using 4 washers (I) and 4 bolts (K). Do not over tighten.

Attach the right armrest (A) and the left armrest (B) to the back frame (D) using 4 washers (I) and 4 bolts (K). Do not over tighten.

ASSEMBLY INSTRUCTIONS



CAVEAT

Note: Please only tighten any bolt once all bolts are placed correctly. If you tighten one bolt, it may cause other bolts to get out of position.

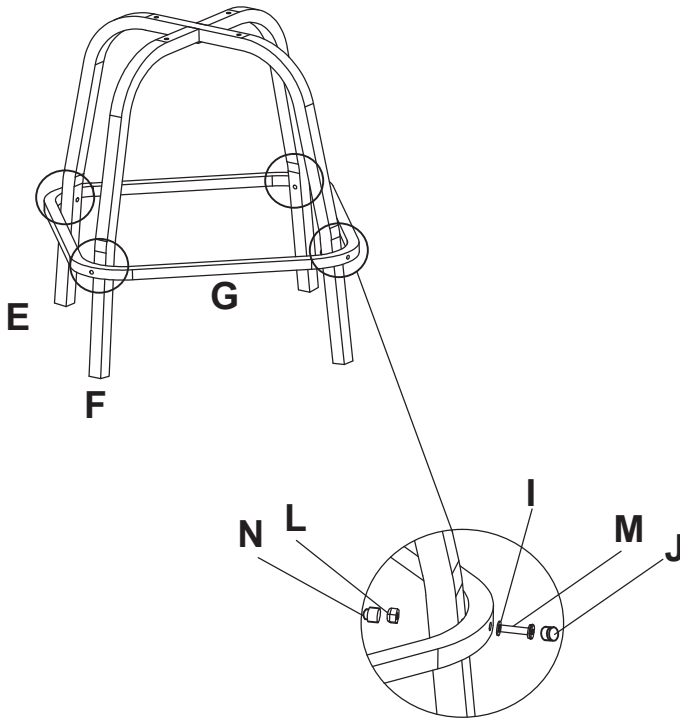

STEP 2

Stack the low leg (F) on the up leg (E), adjust F to match E. Make sure both legs are at the same angle.

Place the up leg (E) on the low leg (F) through a joint in the middle. Then attach the footrest (G) to two legs (E&F) using 4 washers (I), 4 bolts (M) and 4 nuts (L). Do not over tighten.

ASSEMBLY INSTRUCTIONS



CAVEAT

Note: Please only tighten any bolt once all bolts are placed correctly. If you tighten one bolt, it may cause other bolts to get out of position.

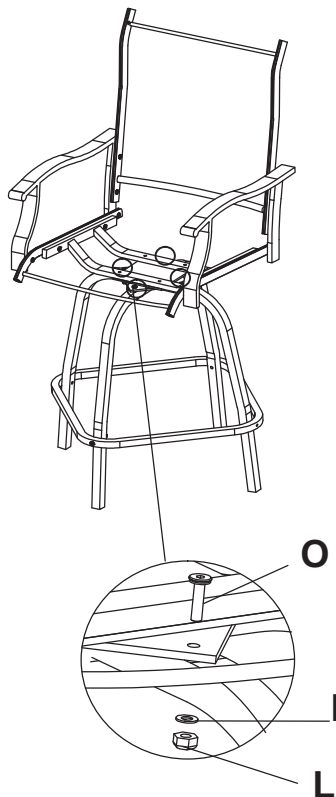

STEP 3

Attach two legs under high chair (E&F) to the seat frame (C) using 4 washers (I), 4 bolts (O) and 4 nuts (L). Do not over tighten.

Upon completion of full assembly and bolted up - all screws can be tightened down.

Button the proper nut cap (J&N).

CARE AND MAINTENANCE

Follow the instructions for the product's material to ensure it stays in the best shape as long as possible. The information below is a general guideline.

Don't hesitate to get in touch with us to learn more.

- Only rinse it thoroughly with clean water to wash away dirt and grime. Never use abrasive cleansers on the furniture since they can attack the surface and leave behind scratch marks.
- For stubborn grime and stains, use a soft sponge and mild soapy water. Then dry it with a cloth or paper towel.
- Check the stability of the screws, nuts, and nut caps before each use. Then, tighten them up after one to two months' use whenever required.
- Avoid improper use, and be careful not to scratch or damage the surface with sharp objects.
- When you move your furniture, lift it rather than pulling or pushing it to avoid damaging the floor, legs, and mounting.