

INSTRUCTION

67CUFT OUTDOOR STORAGE SHED

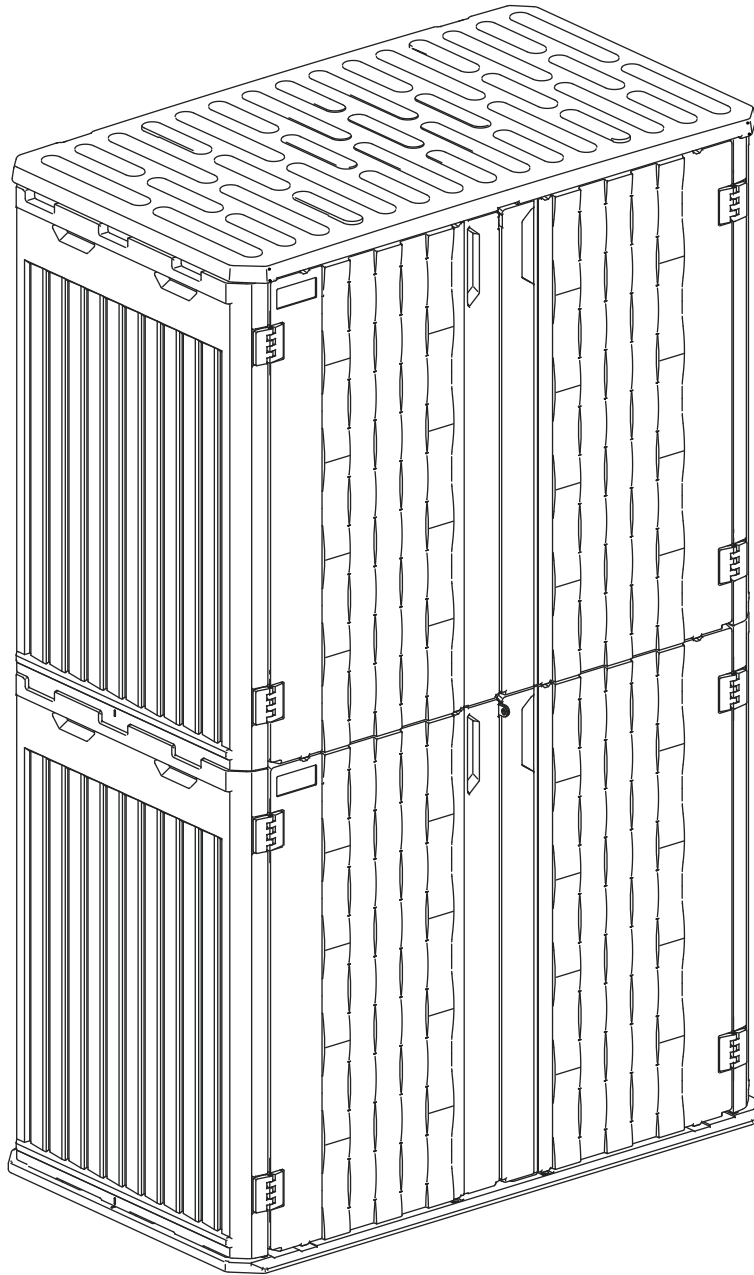

**After-sales mailbox:
Patiofurniture Serviceteam@outlook.com**

NOTICE

ABOUT PRODUCT ASSEMBLY

Do not assemble the storage shed on severely cold or strongly windy days.

We recommend having at least one person assist with the assembly of the storage shed.

Please check your package against the PARTS LIST in these instructions to ensure there are no missing or damaged parts before starting assembly. Kindly contact us if any issues are found.

Please read the instructions thoroughly prior to assembly. Assemble all parts according to the directions in these instructions; do not skip any steps.

Part numbers are imprinted on each component for easy identification. Extra hardware is provided as spare parts for your convenience. Please keep these spare parts for future use.

ABOUT PRODUCT MAINTENANCE

This storage shed must be kept away from open flames.

Do not use the storage shed in extreme weather conditions.

Do not continuously stack items exceeding 20 kg on the roof of the storage shed, as this may cause roof deformation.

Check the storage shed regularly to ensure its stability and that all assembly connections remain intact.

If the storage shed is not in use for an extended period, keep the doors closed and locked when placed outdoors to prevent damage from wind, animals, or other external factors.

Do not store hot items (e.g., recently used grills, blowtorches), flammable materials, or caustic chemicals inside the storage shed.

If there are stains on the storage shed, clean it with a mild soap and water solution. Do not use a stiff brush, bleach, ammonia, or any other caustic cleaners, as these may damage the shed or cause permanent discoloration of the plastic. This is not a manufacturing defect and is not covered under the warranty.

If environmental conditions permit, install the storage shed in a cool, shaded area. Prolonged exposure to direct sunlight may cause panel deformation and accelerate aging.

NOTICE

LEVEL THE GROUND SURFACE

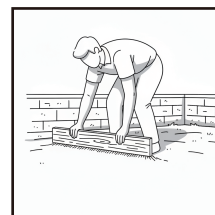

Level the ground surface before unpacking parts and beginning assembly.

REQUIRED TOOLS



Screwdriver

Not included in the accessory pack



Electric Drill

Not included in the accessory pack

PARTS NO.POSITION

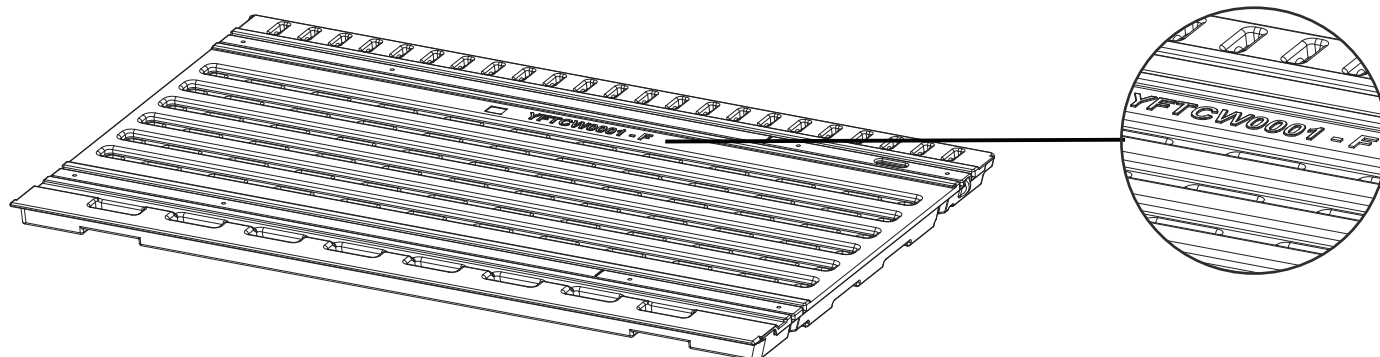

NOTICE

EN

Please keep these instructions for future reference.

Dear Customer

● Thank you for your purchase. When you receive the product, please make sure that all the parts are intact. If any parts are missing, please contact us promptly to request replacement parts.

● Then follow the entire installation instructions to install.

● Each part is crucial, so please be careful not to lose any. It is recommended to store parts with different lettered identifiers in separate boxes or bags to avoid confusion during installation.

A . The outer box is damaged

B . The product is damaged / bent / cracked while you open the box

C . The parts / accessories / assembly tools are missing

D . The instructions are not clear and can not be referred

E . The product has functional problems

F . Other aspects that you are not satisfied with

Please feel free to contact us for help, and provide the following information:

Platform/Shop name/Order id/Buyer's name/Receiver's address/Problem description/Problem pictures

(Patiofurnituresterceteam@outlook.com) will reply within 24 hours and will do our best to resolve the problem for you.



PART LIST

A CARTON

NO .	Parts NO .	Parts Name	Material	Quantity	Specification (mm)	Specification (in)
1	A	Base	HDPE	1	1277*737.5*35.5	50.28*29.04*1.4 in
2	H	Top Panel	HDPE	1	1261*730.2*46.6	49.65*28.75*1.83 in

B CARTON

NO .	Parts NO .	Parts Name	Material	Quantity	Specification (mm)	Specification (in)
3	C	Left Back Panel	HDPE	1	1020.3*604.8*25.7	40.17*23.81*1.01x in
4	B	Right Back Panel	HDPE	1	1020.3*553.7*25.7	40.17*21.8*1.01 in
5	D	Left Side Panel	HDPE	1	1021.3*694.7*119.7	40.21*27.35*4.71 in
6	E	Right Side Panel	HDPE	1	1021.3*694.7*119.7	40.21*27.35*4.71 in
7	F	Left Door	HDPE	1	990.8*593*44	39.01*23.35*1.73in
8	G	Right Door	HDPE	1	990.8*593*44	39.01*23.35*1.73in
9	S1	Plastic Bolts	Plastic	8	M10*15	M0.39*0.59 in
10	S2	Plastic Bolts	Plastic	16	M10*25	M0.39*0.98 in
11	H1	Hinge	Plastic	10	65*65*19	2.56*2.56*0.75 in
12	G1	Metal Washer	Metal	20	54*16*1.2	2.13*0.63*0.05 in
13	C2	Fixing Piece for Top Panel	Metal	2	28*28*16	1.10*1.10*0.63in
14	L4	latch hasp pieces	Metal	1	20*36.7*17.6	0.79*1.44*0.69 in
15	L5	latch hasp pieces	Metal	1	20*41.5*17.6	0.79*1.63*0.69 in
16	S4	M5.5*19	Metal	48	M5.5*19	M0.21*0.74 in
17	S5	M6*15	Metal	40	M6*15	M0.24*0.59 in
18	S3	M4*10	Metal	8	M4*10	M0.15*0.39 in
19	C1	Metal Connection Strips	Metal	12	500*30*6	19.69*1.18*0.24 in
20		Instructions	/		1	
21		Spare Parts	/		1	

C CARTON

NO .	Parts NO .	Parts Name	Material	Quantity	Specification (mm)	Specification (in)
3	C	Left Back Panel	HDPE	1	1020.3*604.8*25.7	40.17*23.81*1.01x in
4	B	Right Back Panel	HDPE	1	1020.3*553.7*25.7	40.17*21.8*1.01 in
5	D	Left Side Panel	HDPE	1	1021.3*694.7*119.7	40.21*27.35*4.71 in
6	E	Right Side Panel	HDPE	1	1021.3*694.7*119.7	40.21*27.35*4.71 in
7	F	Left Door	HDPE	1	990.8*593*44	39.01*23.35*1.73in
8	G	Right Door	HDPE	1	990.8*593*44	39.01*23.35*1.73in

Please save the spare parts

PART LIST

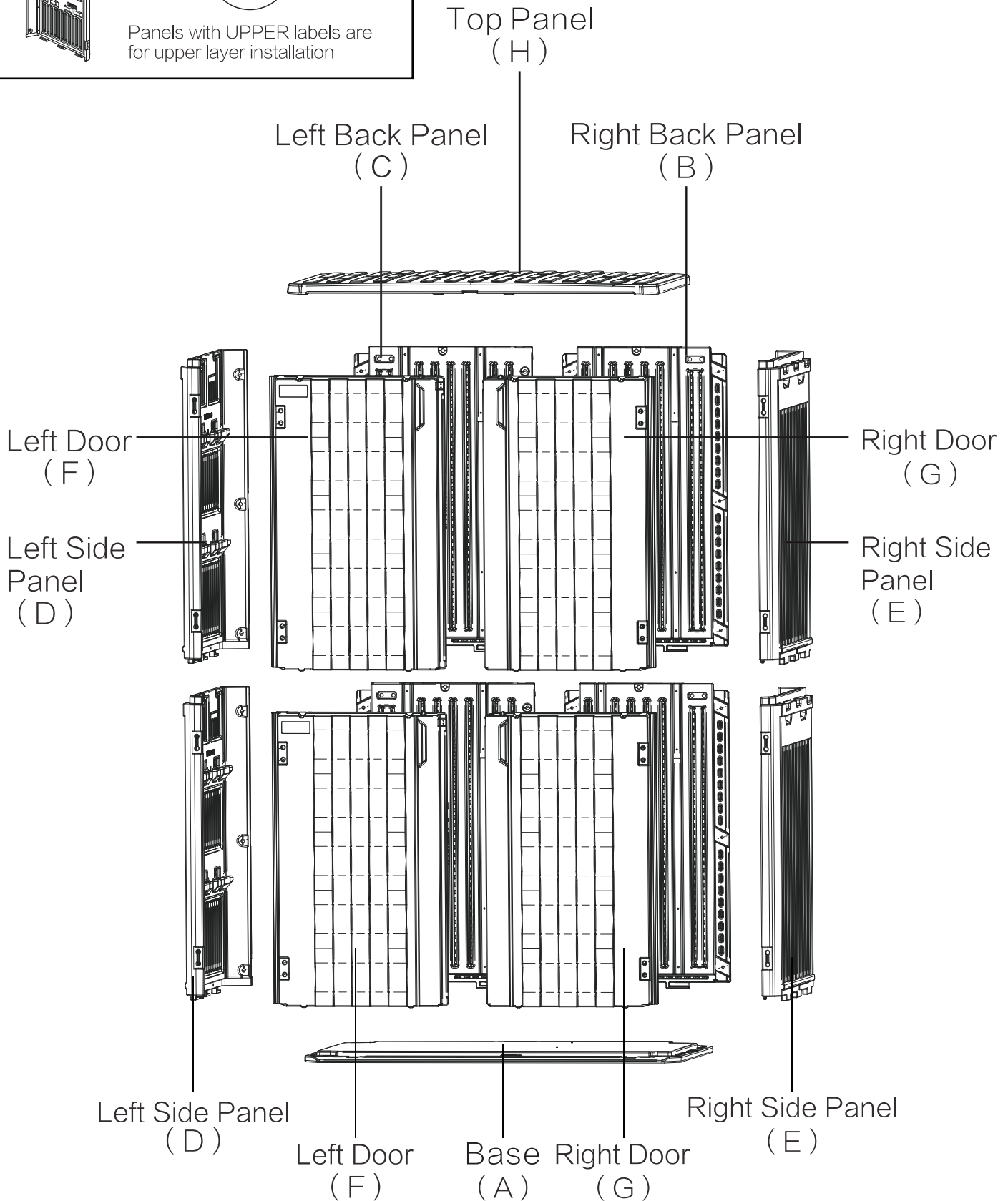
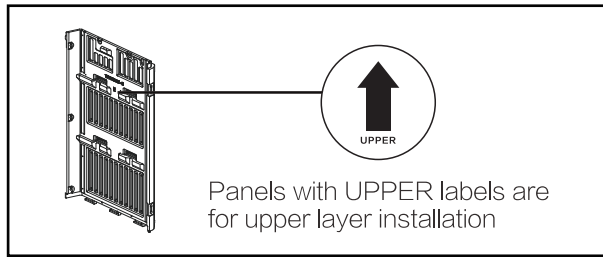

PART LIST

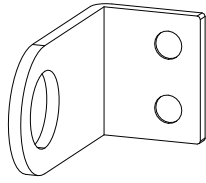

latch hasp pieces
(L4)
1pcs

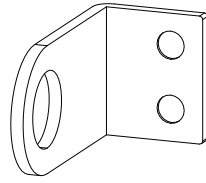

latch hasp pieces
(L5)
1pcs

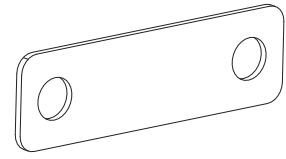

Metal Washer
(G1)
20pcs

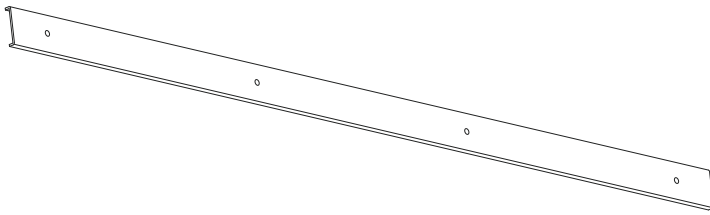

Metal Connection Strips
(C1)
12pcs

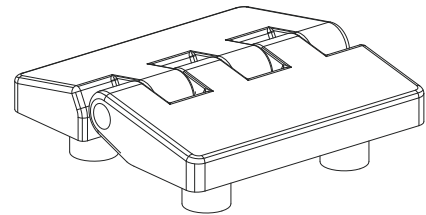

Hinge
(H1)
10pcs

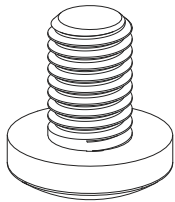

Plastic Bolts
(S1)
8pcs

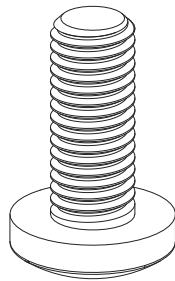

Plastic Bolts
(S2)
16pcs

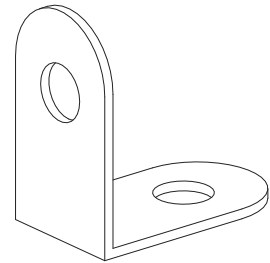

Fixing Piece for Top Panel
(C2)
2pcs

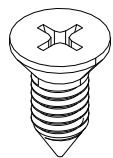

M4x10
(S3)
8pcs

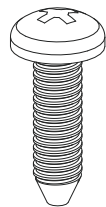

M5.5x19
(S4)
48pcs

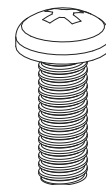

M6x15
(S5)
40pcs

STEP

01

To prevent damage to the plastic parts, use a manual screwdriver to fasten the screws. If an electric drill must be used, set it to the lowest power level.

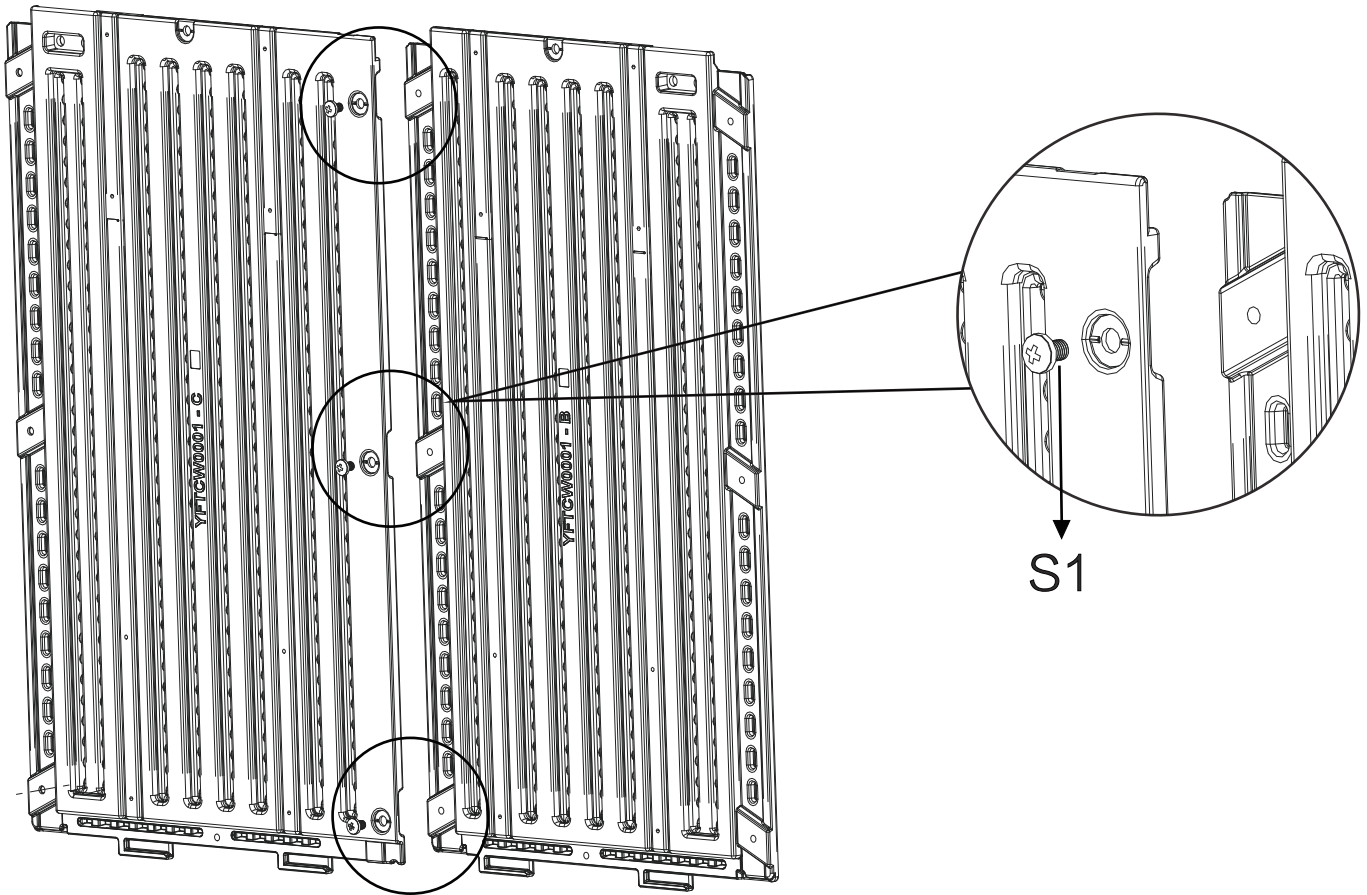

Connect two back panels by screws

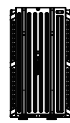

B↑



C↑

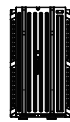

B



C

STEP

02

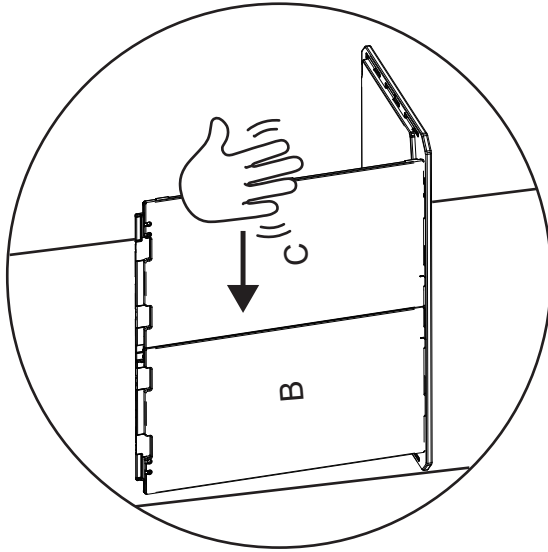

Lay the product flat as shown in the figure, and tap the parts until they snap into the slots.

lay flat

Align at point position and line, and sliding in the back panels.

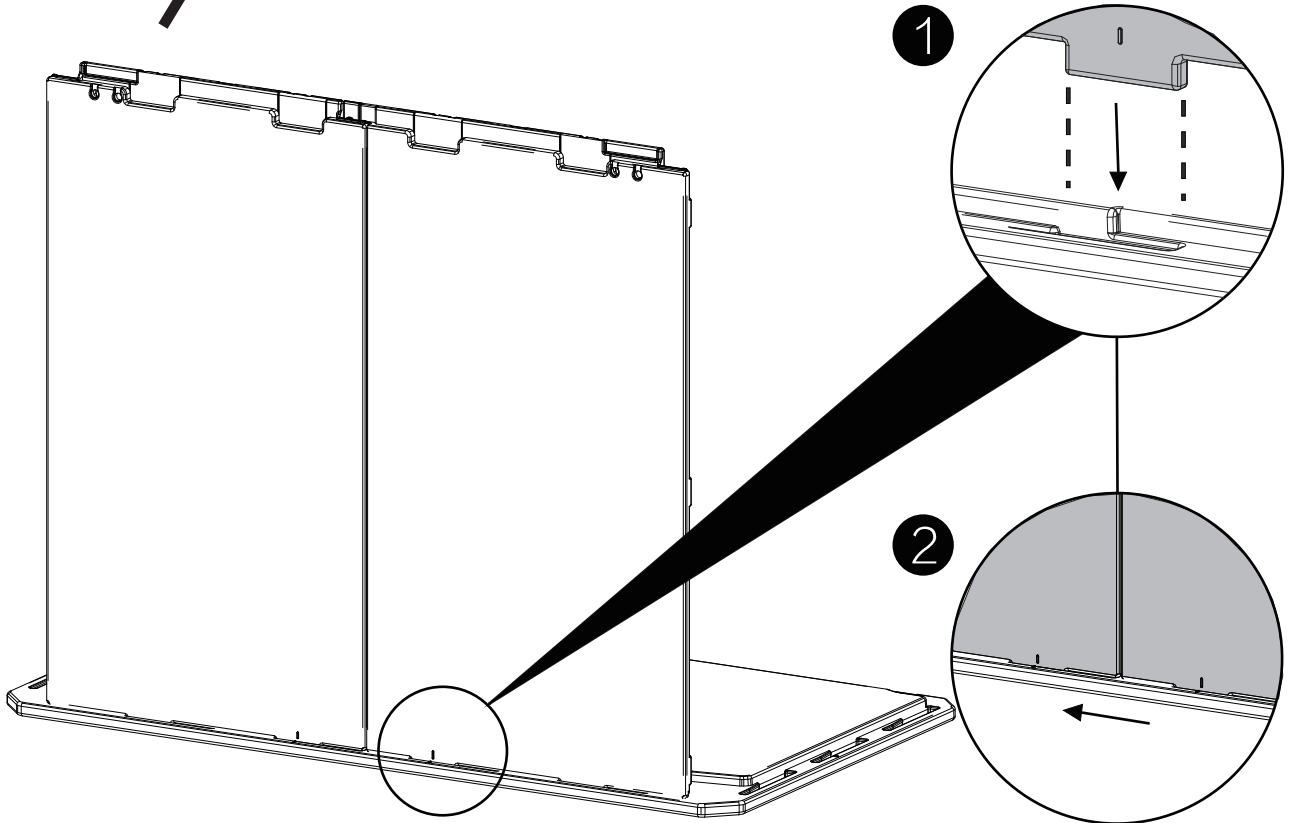

Install the back panels onto the base

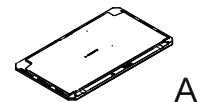

STEP

03

Invert the assembly with the side panels inserted, then press or tap downwards by hand to ensure the side panels are firmly locked into the base panel.

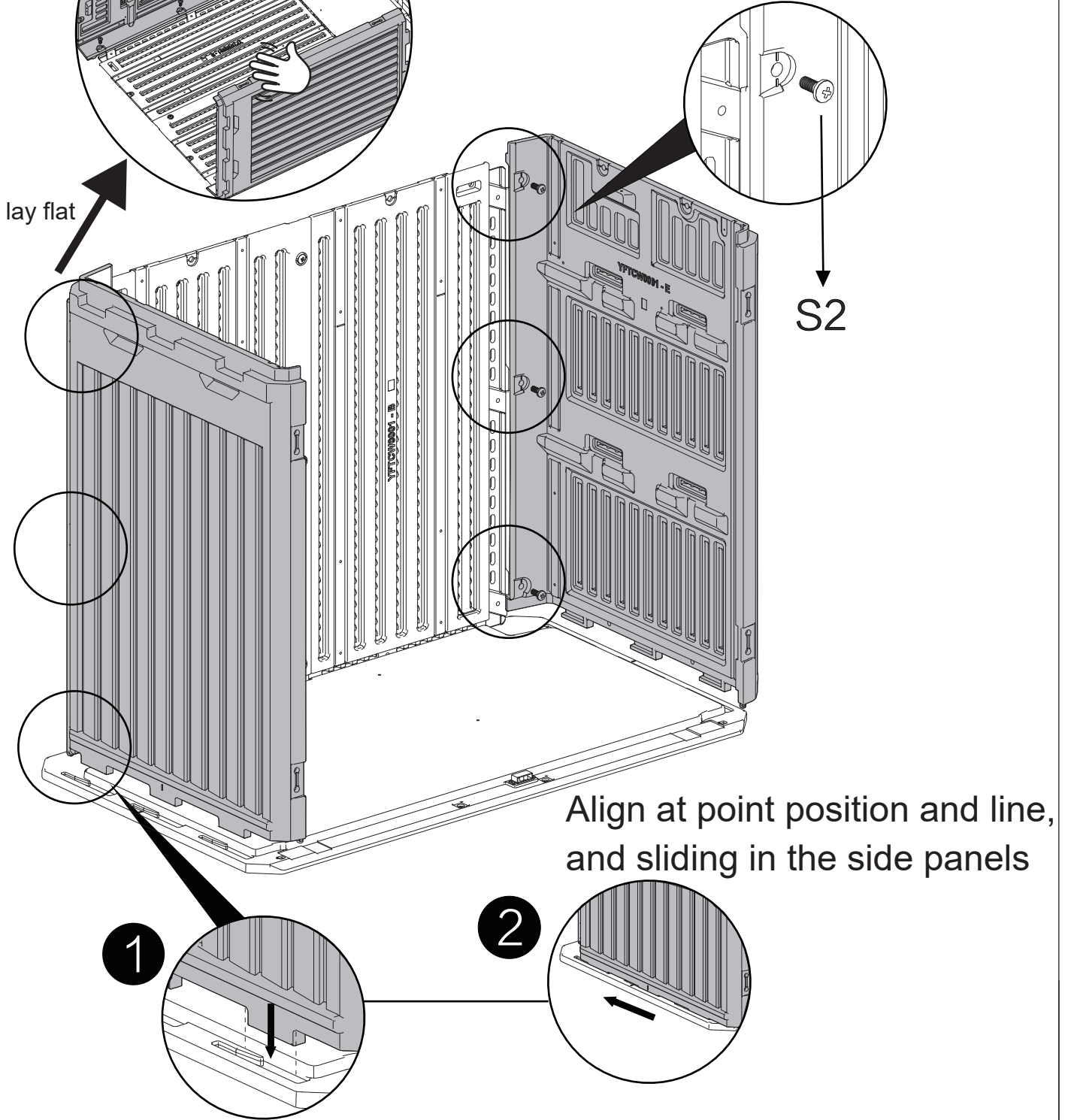

Install the side panels



04

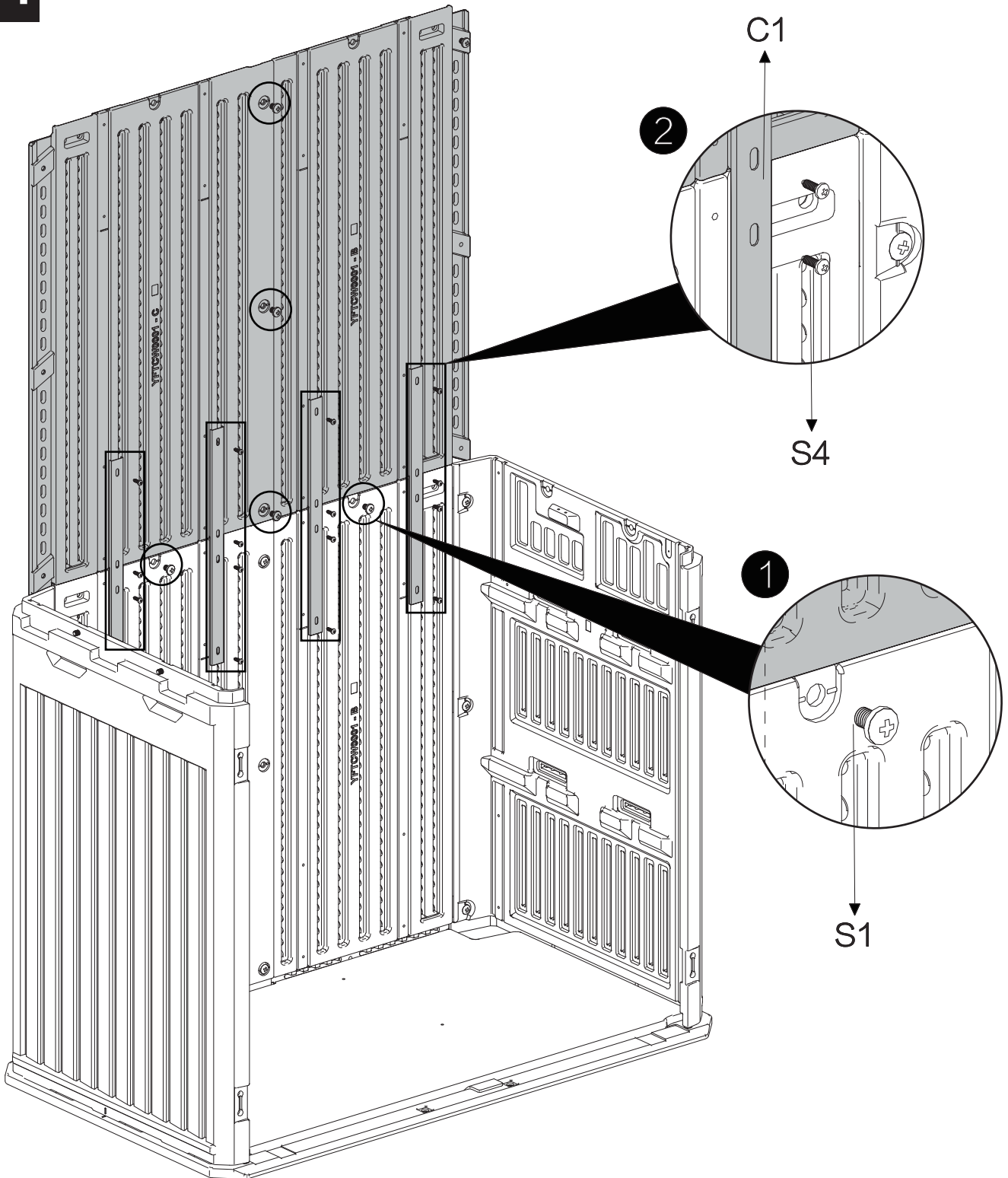

Install the upper layer
back panels

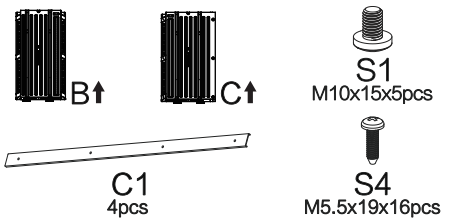

05

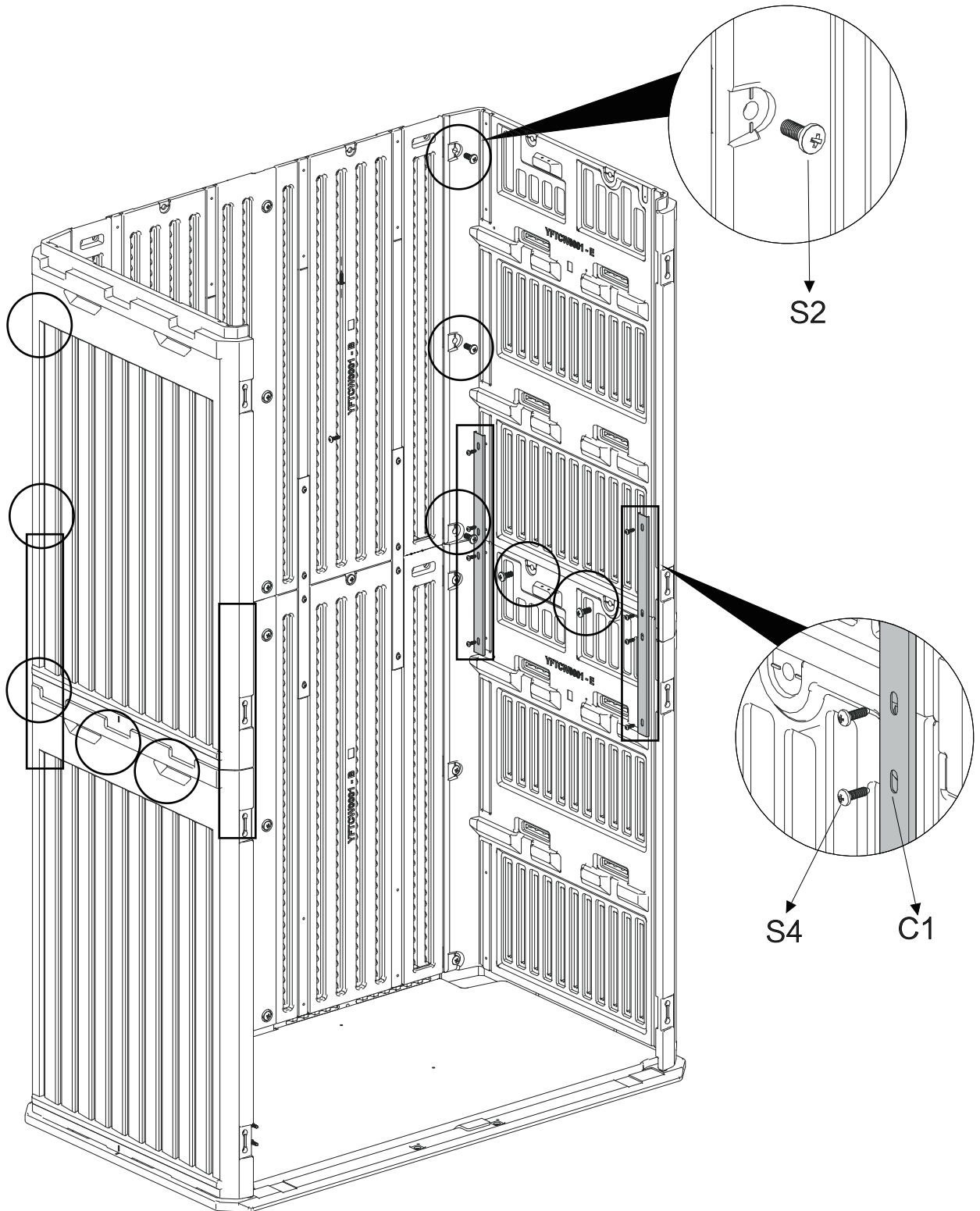

Install the upper layer side panels



D



E



C1
4pcs

S2
M10x25x10pcs

S4
M5.5x19x16pcs

06

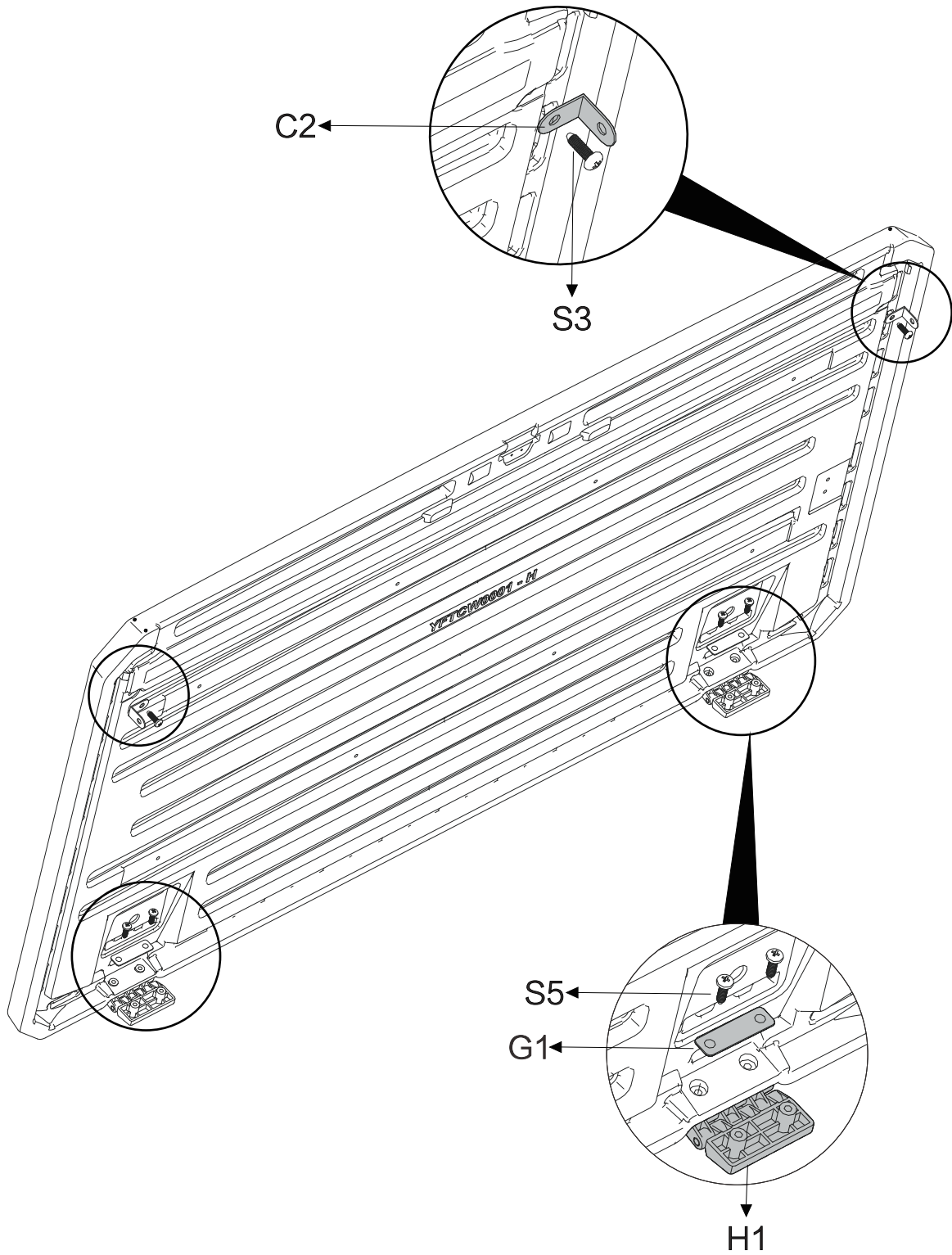

Install accessories onto the top panel



H



H1
2pcs



G1
2pcs



S3
M4x10x2pcs



S5
M6x15x4pcs



C2
2pcs

STEP

07

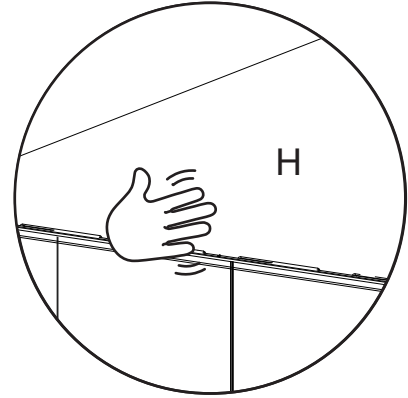
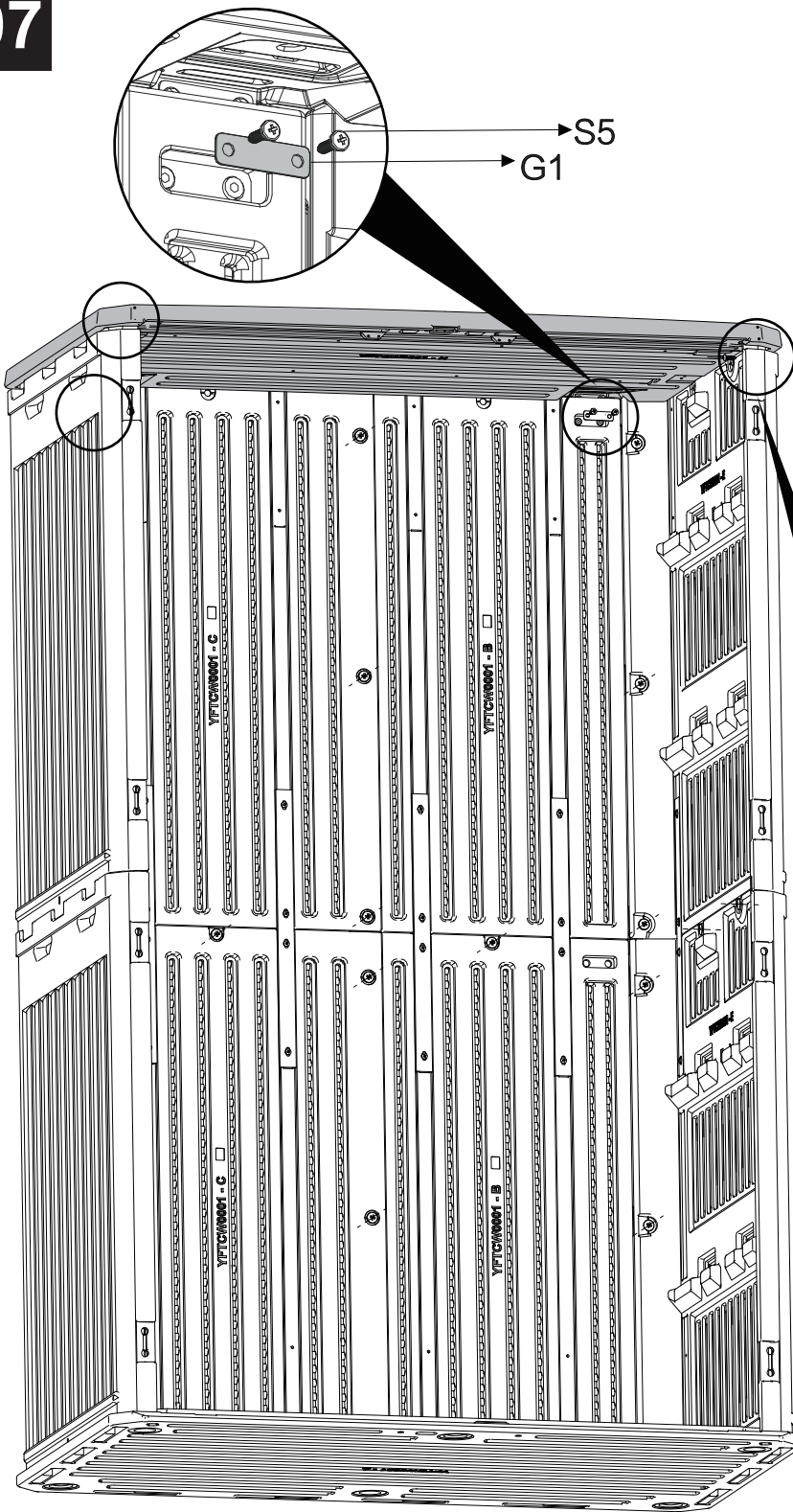

Press or tap downwards by hand to ensure the cover panel is firmly locked with the side panels.

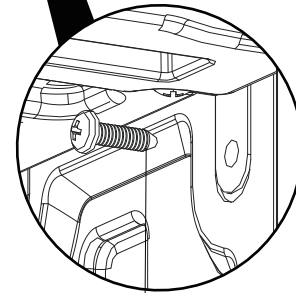

S3

Install the top panel onto the cabinet



G1
2pcs



S5
M6x15x4pcs



S3
M4x10x2pcs

08

YFTCW0001-F-UOOER Front
YFTCW0001-F Front

YFTCW0001-G-UPPER Back
YFTCW0001-G Back

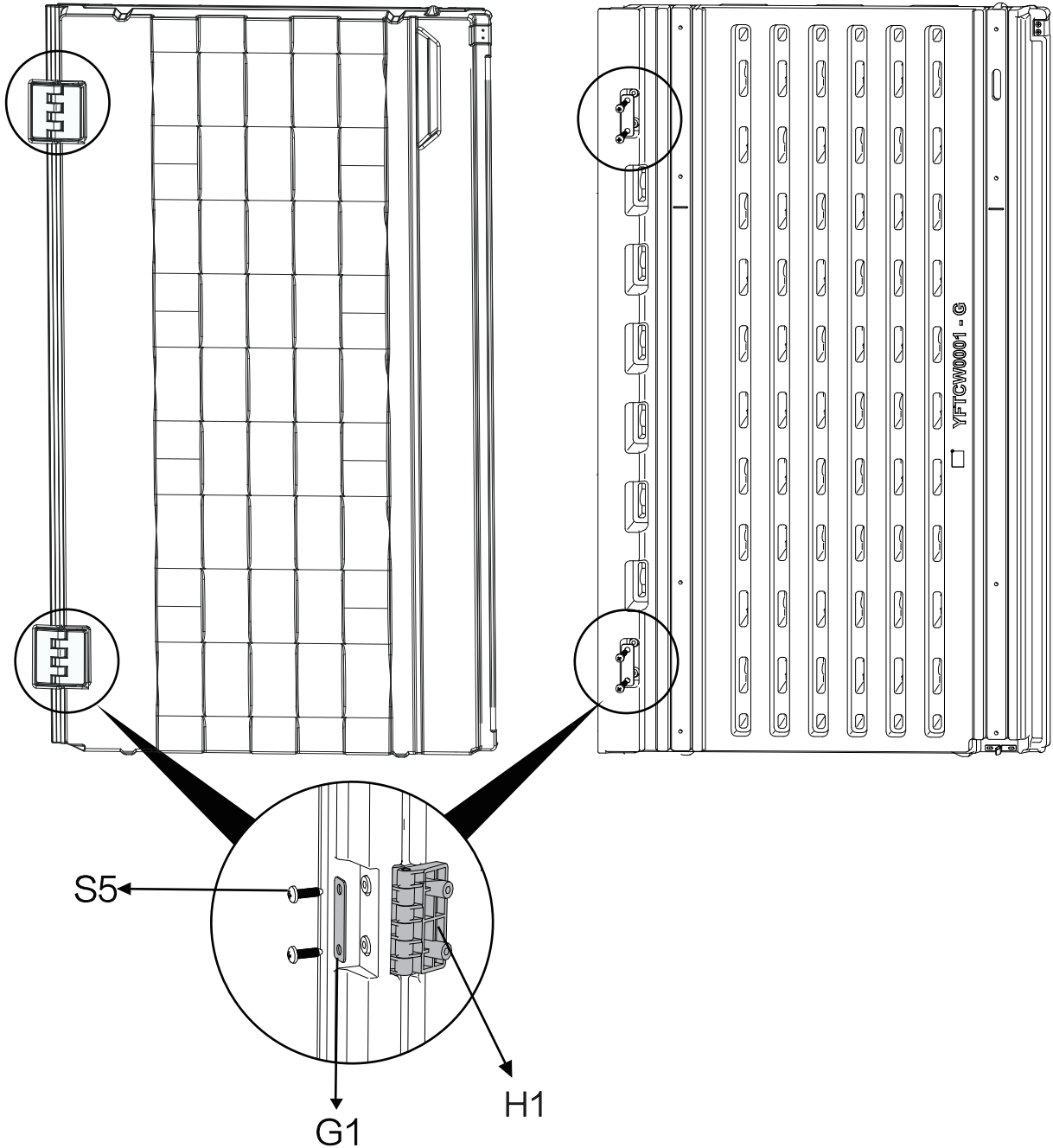



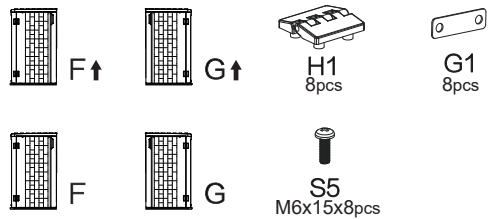

Install the door hinges

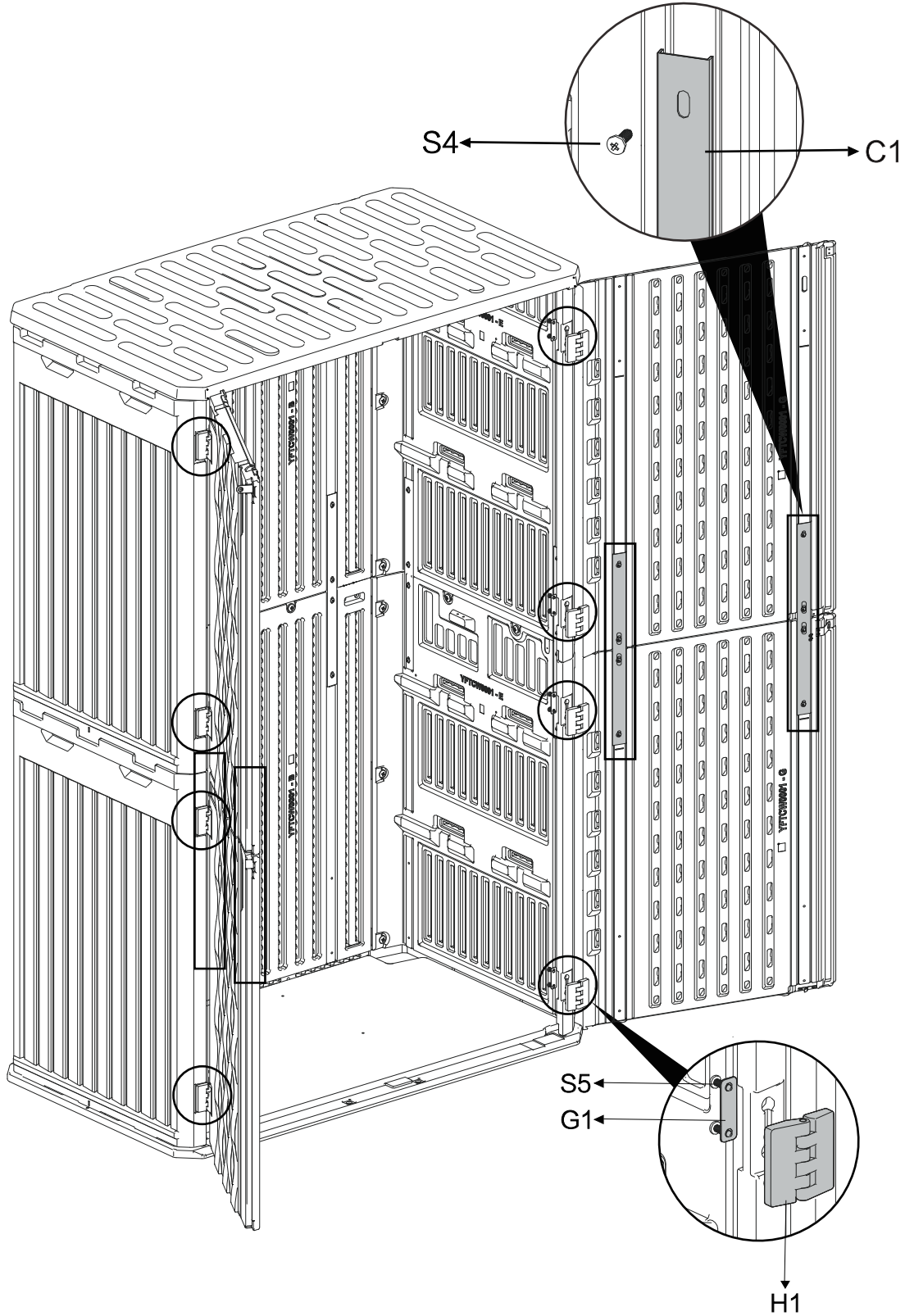

09



Install door panels

- 
S4
M5.5x19x16pcs
- 
S5
M6x15x16pcs
- 
C1
4pcs
- 
G1
8pcs

10

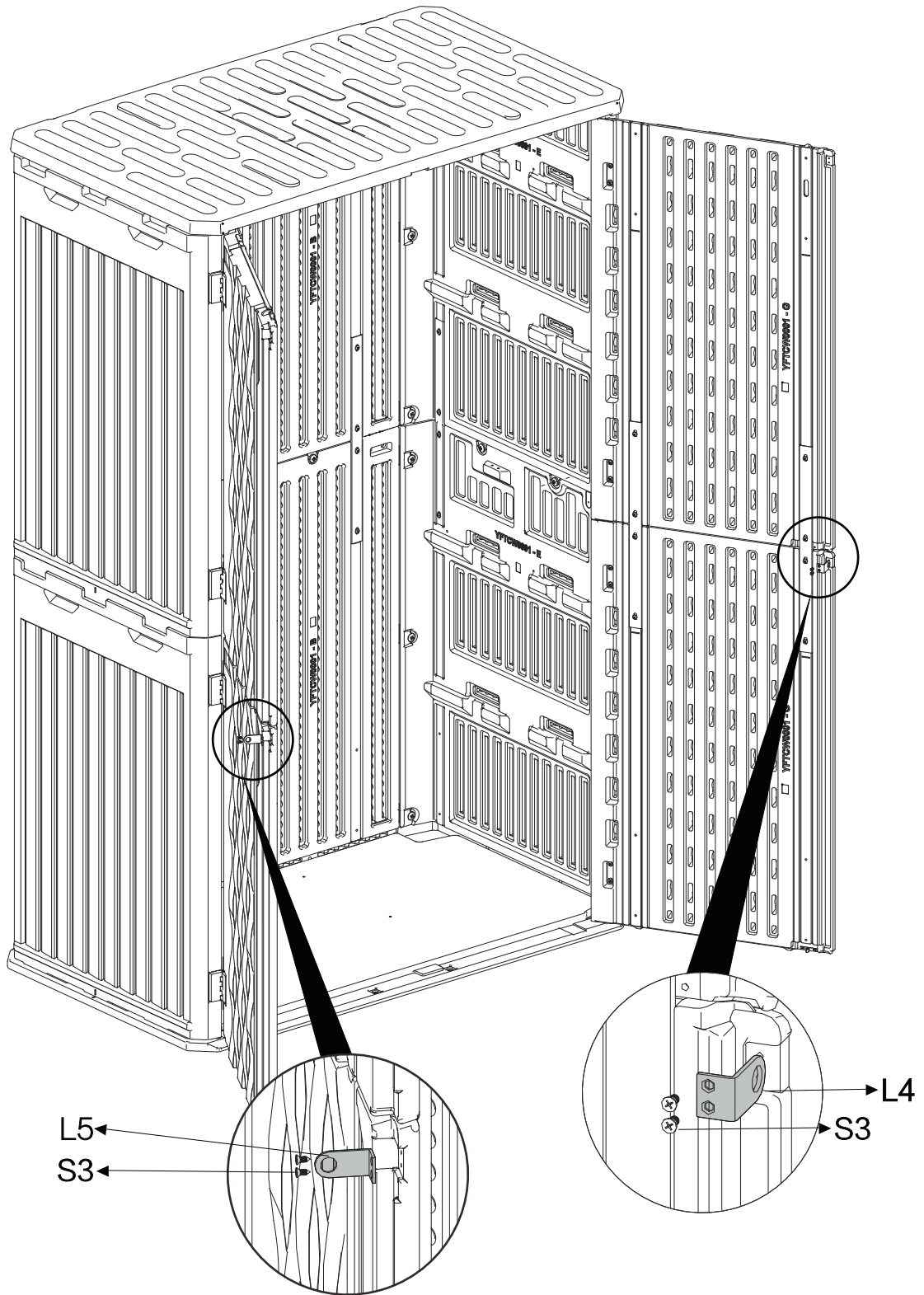

Install latch pieces

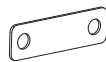

G1
2pcs



S5
M6x15x4pcs



S3
M4x10x2pcs

EN

AFTER-SALE SERVICE

If you have any suggestions for our products or notice any quality issues, please contact us first. Our after-sales team will respond within 24 hours and will do everything possible to provide you with a satisfactory solution.

Guaranteed Customer Service

Your shopping experience is very important to us!

Feel unsatisfied? **Contact us!**

Have any questions? **Contact us!**

Wanna Share how wonderful our smart products make your home?

Share your pictures with us.

Any suggestions? **Contact us!**

We will check and give feedback.



Patiofurniture Serviceteam@outlook.com

