

★ ★ ★ ★ ★
QUEEN



Thank you for purchasing this quality product. Be sure to check all packing material carefully for small parts which may have come loose inside the carton during shipment. Identify and count all parts and compare with the parts list below.

Read all assembly and care instructions carefully before using this product. Save these instructions for future reference.

- Select a smooth, level surface to place the bed frame parts.
- Assemble components on a soft, clean surface to avoid scratching and/or damaging the finish.
- Ensure all parts are accounted for before disposing of packaging.
- Moderate risk of death or serious injury to children and animals: The plastic packaging of the Bed Frame is a potential suffocation hazard. Leaving children or animals unsupervised with the empty packaging may lead to death through suffocation. Do not leave children or animals unsupervised. Dispose of unnecessary packaging immediately.
- This package contains small parts. Keep away from children prior to and during assembly. Adult assembly required. Screws left after assembly should be kept out of reach of children.

ASSEMBLY

Note: The Bed Frame should be assembled by two (02) adults. If you assemble the Bed Frame alone, be careful when lifting heavy parts. Ensure the assembly area is larger than the Bed Frame. Follow the steps carefully to assemble the Bed Frame correctly.

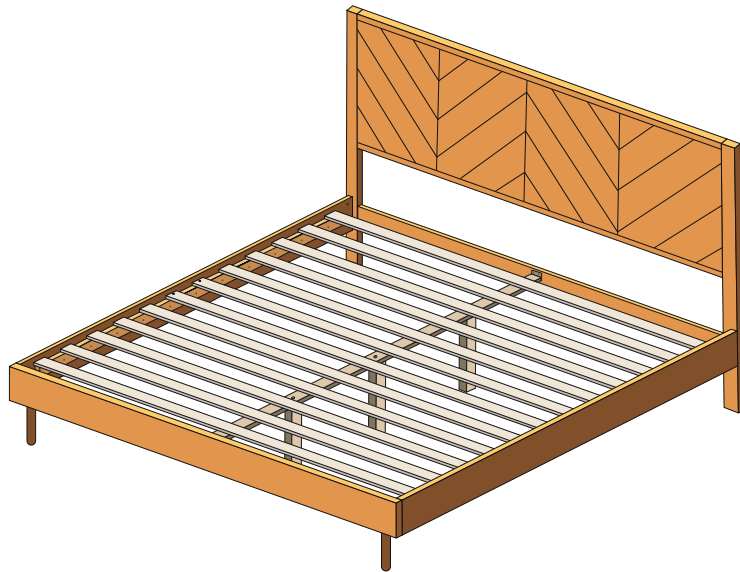

IMPORTANT INFORMATION

Under normal use, Bed Frame will last for years. It is, however, important to follow basic care tips to prolong the life of your Bed Frame.

USE & CARE

Your bed frame does not require special waxing or oiling. You may dust at any time with a clean, dry, soft cloth. If deeper cleaning is necessary, use a damp, non-abrasive cloth and a solution of cool water and mild detergent, immediately wipe dry.

Moisture and heat can damage the wood finish. To prevent moisture damage, promptly wipe up any spills or any other moisture. To prevent heat damage, avoid placing your Bed Frame too close to heat sources such as HVAC vents and radiators.

Wood may expand and contract with seasonal humidity changes. Maintaining consistent humidity levels will minimize movement in the wood and help prevent warping.

Over time, air and sunlight may change the color of natural wood. To prevent fading, avoid placing your Bed Frame in direct sunlight.

Avoid dragging sharp or rough objects across the surface of your wood Bed Frame, or it will become scratched.

Ensure that your headboard is securely attached regularly.

Any modification or failure to follow the recommended care will void the product warranty.

WARRANTY INFORMATION

Thank you for choosing . We stand behind our brand and the quality of the items we sell, and are committed to only producing best-in-class products that are carefully tested and constructed to stand heavy daily use by the most demanding users. When you buy products through our authorized distributors and retailers, you can be assured that you are getting the authentic products. However, despite our efforts, mistakes do occasionally happen. In case of any concerns, please refer to our policy below or send us a message.

Warranty Policy

- 30-day satisfaction warranty across our catalogue.
- 5-year limited warranty applies to all bed frames purchased as new from an authorized retailer.
- Proof of purchase is a requirement.
- Photos of the defective part(s) are highly recommended.
- This warranty is void if the product is altered or improperly used.

Your new product comes with a 5-year limited warranty against defects in workmanship and materials. Your product will be replaced or you will receive a prorated refund, at our option, should it be found defective because of faulty workmanship or structural defects other than specific limitations contained herein.

warrants your product against manufacturing defects only and does not cover damages that result from misuse.





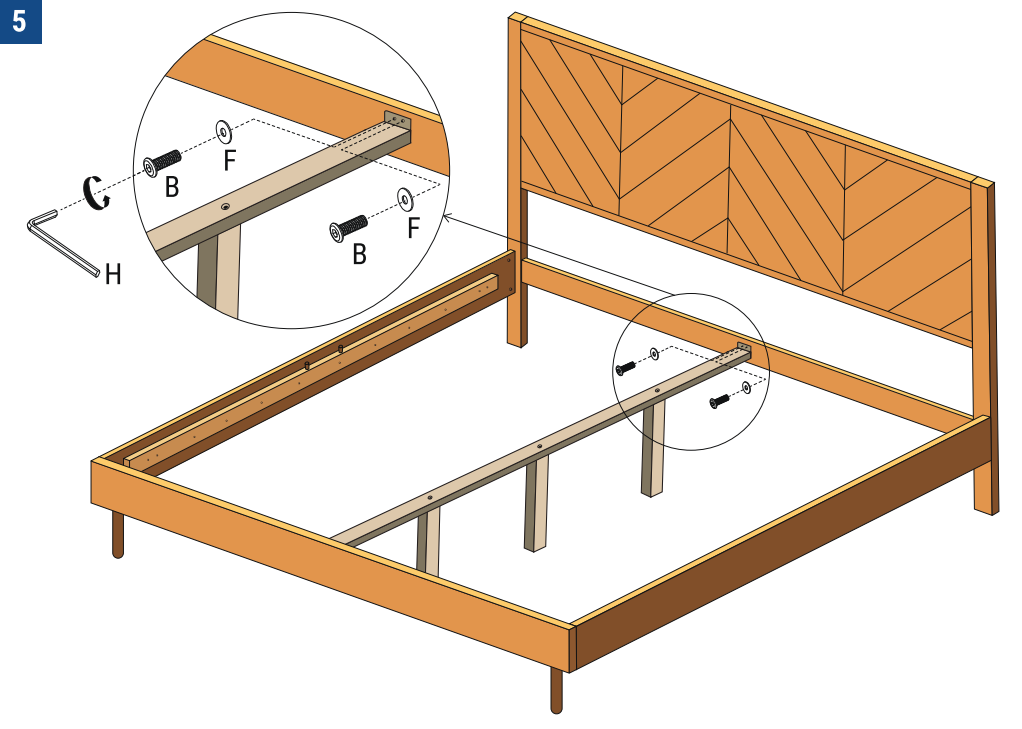

Manufacturing defects include circumstances where the product has broken under normal use and no longer provides proper support for your mattress. Proper support is defined as a smooth, flat, rigid surface. In the event you encounter a manufacturing defect, please stop using this product immediately and contact customer service. The warranty and financial responsibility of the manufacturer applies only to the product itself and does not extend to items that might be used with the purchased product.

The warranty applies only when the product has been properly used by the original purchaser. Proper use means using the bed frame on a level surface with an equal distribution of weight. Proper use also means that the product was not abused by the consumer, as defined by the manufacturer, including not exceeding the weight capacity. The warranty is voided if any structural modification is made to the bed frame or any part of the bed frame as delivered is removed.

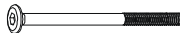
WARNING! is not responsible for normal wear and tear, for products used commercially or for failures caused by accidents, abuse, alteration, modification, misuse, and improper care.

No claims, representations or warranties, whether expressed or implied, are made by our company as to the safety, reliability, durability, and performance of any of our company's products. Furthermore, our company accepts no liability whatsoever for the safety, reliability, durability, and performance of any of our company's products. In no event shall be liable for incidental or consequential damages.

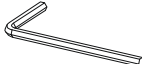

HARDWARE LIST			
A		Ø6x90 BOLT	4
B		Ø8 x 15 BOLT	4
C		Ø8 x 35 BOLT	10
D		Ø8 x 50 BOLT	2
E		Cross dowel	4
F		Washer	14
G		Washer	2
H		M5	1

