

INSTRUCTION MANUAL



FOUR-TIER GREENHOUSE SHELF





IF YOU PURCHASED THE PRODUCT ONLINE AND HAVE
ANY QUESTIONS OR CONCERNS
PLEASE CONTACT US VIA EMAIL, TEXT, OR PHONE

Before You Start

1. Please read all instructions carefully.
2. Retain instructions for future reference.
3. Before assembly, separate and count all parts and hardware.
4. Read through each step carefully and follow the proper order.
5. We recommend that, where possible, all items are assembled near to the area in which they will be placed in use, to avoid moving the product unnecessarily once assembled.
6. Always place the product on a flat, steady, and stable surface.
7. Keep all small parts and packaging materials for this product away from babies and children as they potentially present a serious choking hazard.

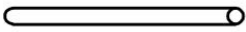
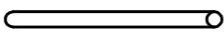
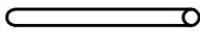
Parts list

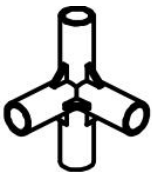
TIPS: The following component list only shows the quantity of components required for a single unit. Our product is packaged in 2 units, and the number in parentheses (X) shows the total quantity needed for both units.

<p>1.Long tube</p>  <p>81CM</p> <p>X8/(16)</p>	<p>2.Riser support</p>  <p>30.5CM</p> <p>X12/(24)</p>	<p>3.Short tube</p>  <p>25.5CM</p> <p>X8/(16)</p>	<p>4. Metal mesh plate</p>  <p>X4/(8)</p>
<p>D. 3-hole plastic connector</p>  <p>X8/ (16)</p>	<p>E. 4-hole plastic connector</p>  <p>X8/ (16)</p>	<p>Z. Nylon cable tie</p>  <p>X18/ (36)</p>	

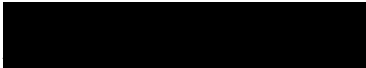

STEP 1. Insert the Long tube (1) and Short tube (3) into the 3-hole plastic connector (D) as shown in the diagram.

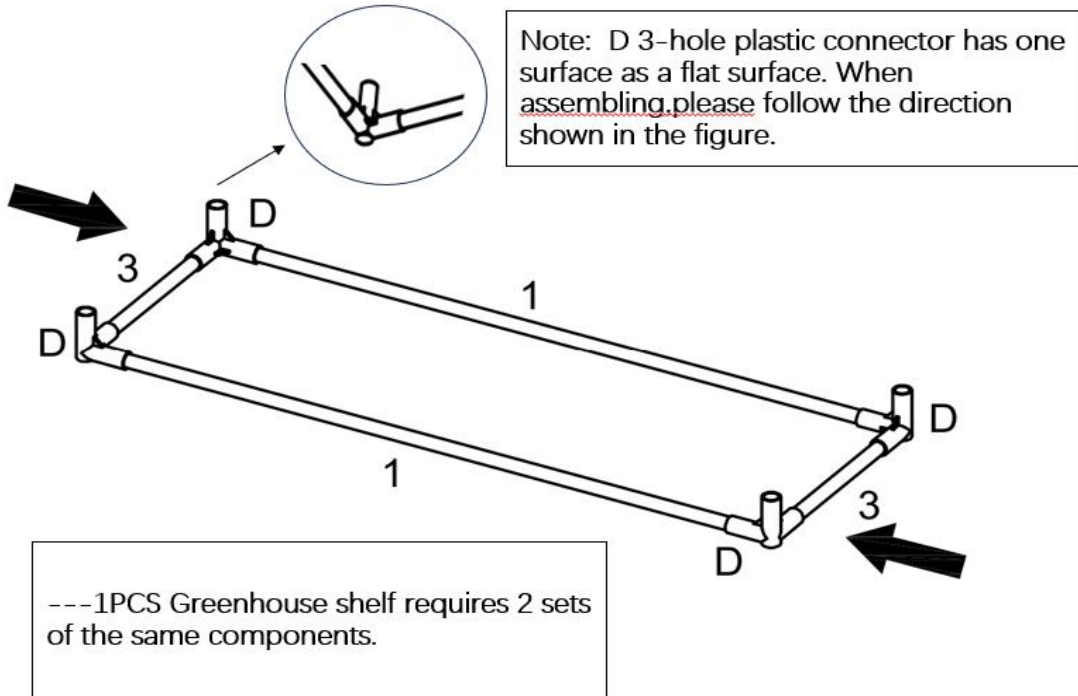

STEP 2. Insert the Long tube (1) and Short tube (3) into the the 4-hole plastic connector (E) as shown in the diagram.

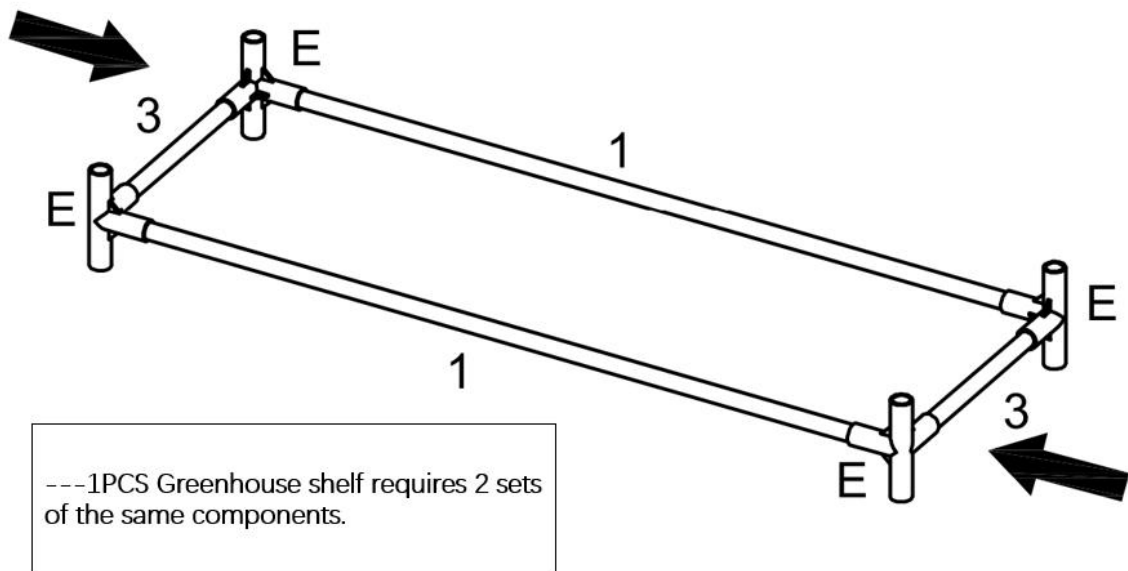

STEP 3. According to the illustration, use the Riser support (2) to link the components pre-assembled in STEP 1 and STEP 2.

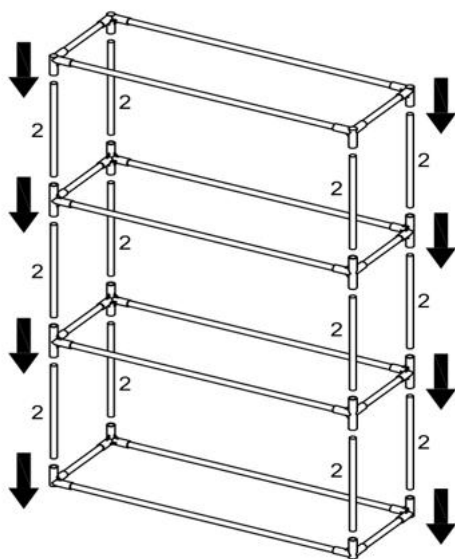

Note: All metal pipes and plastic parts must be assembled firmly to ensure a stable installation!

STEP 4. According to the illustration, place the Metal mesh plate (4) on the shelf one by one, and then secure them with the Nylon cable ties (Z).

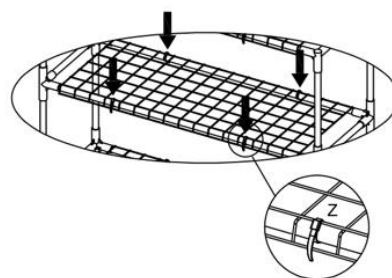
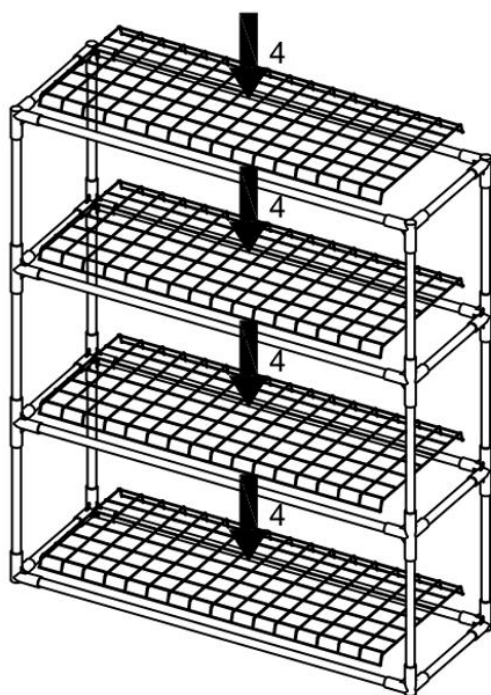

Load-bearing warning!

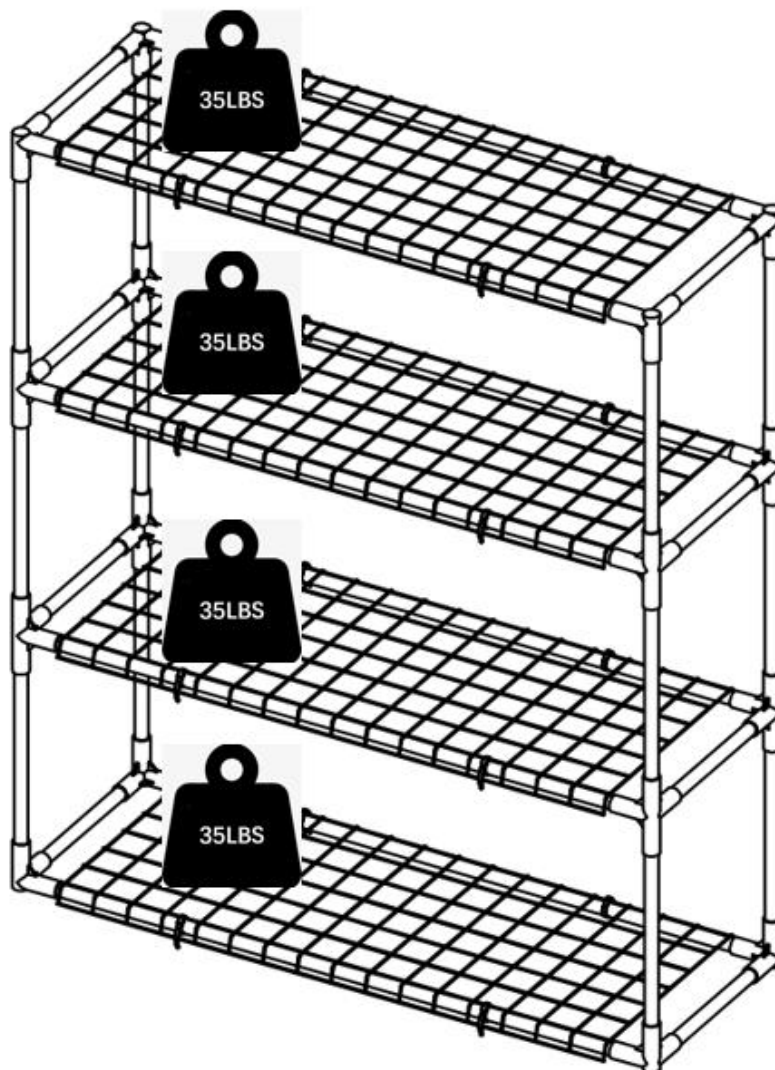

Warning:

- 1. When using the product, ensure the ground is flat. Do not place it on an inclined slope or uneven surface to prevent the flower stand from tipping over.**
- 2. If the product has been moved, please check whether all the metal tubes and plastic parts are securely connected before use.**