

# PREPARATION

Before beginning the assembly of the product, make sure all parts are present. Compare the parts with the package contents list and hardware contents list. If any parts are missing or damaged, do not attempt to assemble the product. Tool required for assembly (included): Allen Key.

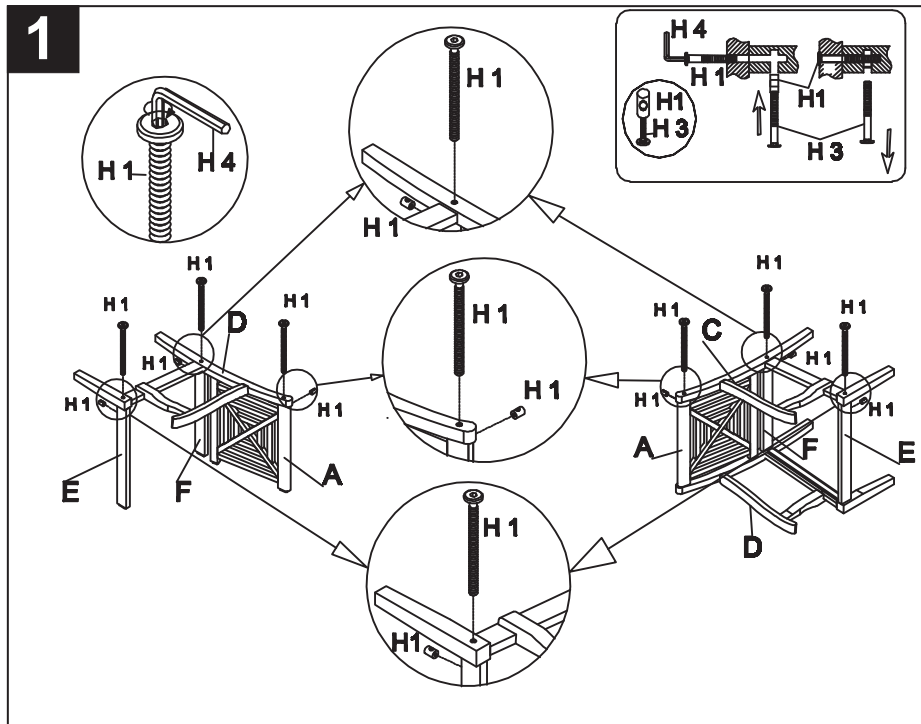

Step 1: attach right side (D) to the back (A). Then attach support L (E) and support S (F) to the right side (C) as shown on the picture by using the Allen Bolt (H1) and tighten with the Allen Key (H4). Continue with the left side (C) in the same way. Make sure to tighten all bolts (H1) before you continue with step 2.

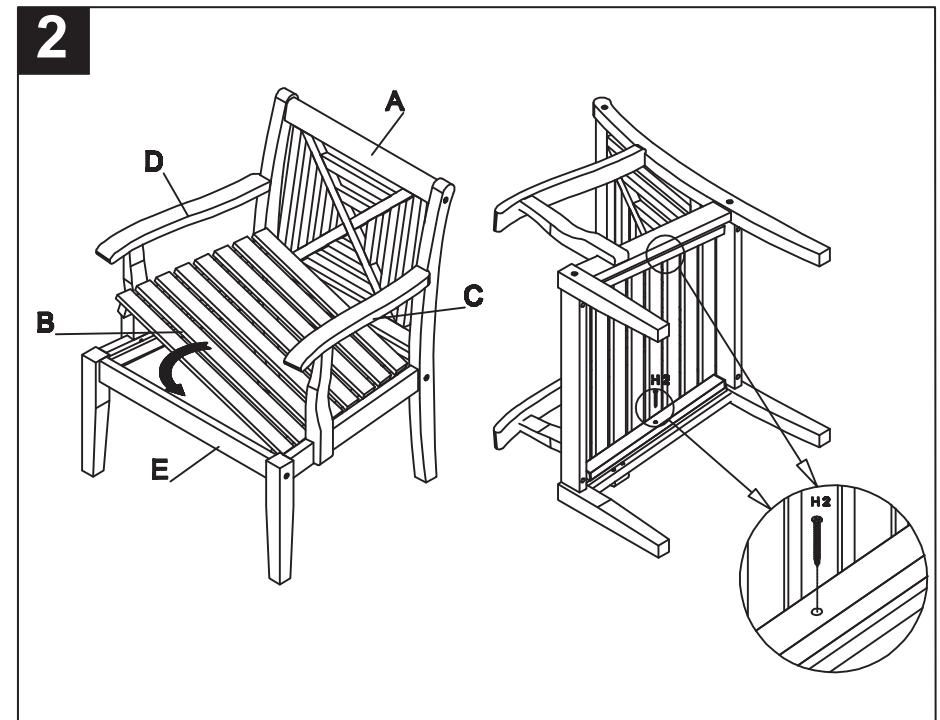

Step 2: put the seat (B) inside the chair as shown on the picture and use the screws (H2) to attach it to the chair by using a screwdriver.









## CARE AND MAINTENANCE

Store outdoor furniture indoors or cover well when it is not in use. Dust regularly with small brush or vacuum. Spills should be taken care of immediately before they harden or stain with a slightly dampened sponge.

## NOTICE

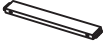
Please make sure that you have all parts indicated before you begin assembly of this item.

### Part List and Hardware List

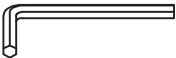
PIECE	DESCRIPTION	PICTURE	QUANTITY
A	Back		1X
B	Seat		1X
C	Left side		1X
D	Right side		1X
E	Support L		1X
F	Support S		1X
H1	Allen Bolt M6x80		6X
H2	Screw M4x35		2X
H3	Bolt extra M6x50		1X
H4	Allen Key		1X

Product Dimension: 25.59"W x 24.8"D x 31.89"H

Weight capacity : 300 lbs

Warning : Do not stand on the chair

Warning : Do not torque bolts / screws

