

SH1014

ASSEMBLY INSTRUCTION

A

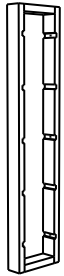

1pcs

B

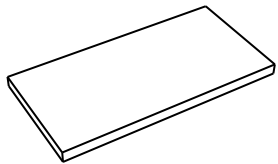

5pcs

C

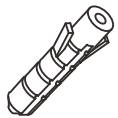

fisher S6
3pcs

D



Screw /50mm
3pcs

E

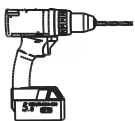

Not Included

F

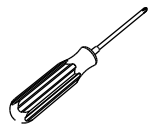

Not Included

Make a hole in the wall

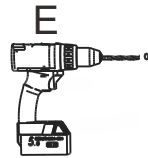

Step 1

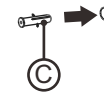

Step 2

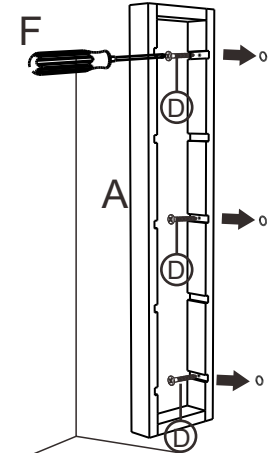

Step 3

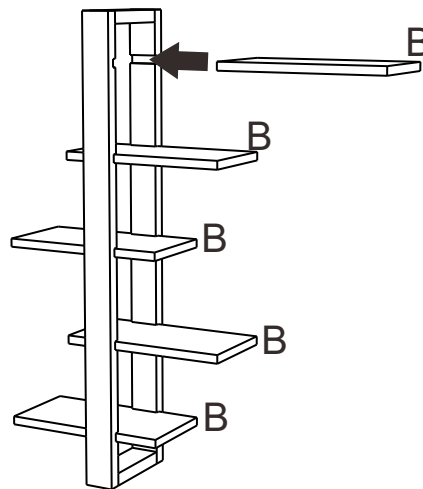

Step 4

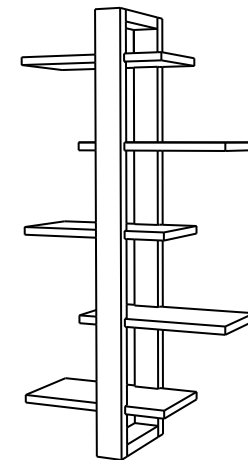

Step 5