





# ASSEMBLY INSTRUCTIONS FOR ACME FURNITURE



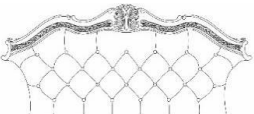
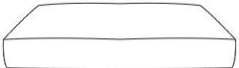

## MODEL#LV03831

- LV03831-1 MAXIMUS LOVESEAT – FRAME, CUSHION, ARMS,LEGS & 3 PILLOWS
- LV03831-2 MAXIMUS LOVESEAT – BACKREST

Thank you for purchasing this quality product. Be sure to check all packing materials carefully for small parts, which may have come loose inside the carton during shipment. Separate, Identify and count all parts and metal hardware. Compare with all parts listed to be sure all parts are present. If any part(s) are missing or damaged, please contact your local furniture dealer. For efficient and speedy service, please indicate the model number and code letter of part(s) needed.

\*\*\*Do not fully tighten screws until fully assembled\*\*\*

<b>PARTS NAME</b>			
NO.	DESCRIPTION	SKETCH	Q'TY (PCS)
A	SEAT FRAME		1
B	LEFT SIDE FACING (LSF) ARM		1
C	RIGHT SIDE FACING (RSF) ARM		1
D	BACKREST		1
E	SEAT CUSHION		1
F	LEG		4

<b>HARDWARE REQUIRED</b>			
NO.	DESCRIPTION	SKETCH	Q'TY (PCS)
1	FLAT WASHER Ø5/16 x 3/4"		11
2	WASHER Ø5/16 x 1/2"		11
3	BOLT Ø5/16 x 2"		8
4	ALLEN KEY Ø5/16 x 3/4"		1
5	BOLT Ø5/16 x 3/4"		3

### **Attention**

\*\*\* Some number parts listed on the instruction sheet may not be in parts bag as they may be assembled. Carefully check parts and packing materials prior to ordering replacements.\*\*\*

# ASSEMBLY INSTRUCTIONS FOR ACME FURNITURE

## MODEL#LV03831

- LV03831-1 MAXIMUS LOVESEAT – FRAME, CUSHION, ARMS,LEGS & 3 PILLOWS
- LV03831-2 MAXIMUS LOVESEAT – BACKREST

### How to assemble:

#### **STEP 1:**

Lay the seat frame (A) on its back side to reach the holes to secure the bolts for the arms. Assemble the LSF arm (B) and RSF arm (C) to the seat frame (A) using Allen Key (4) with hardware, 1,2, and 3.

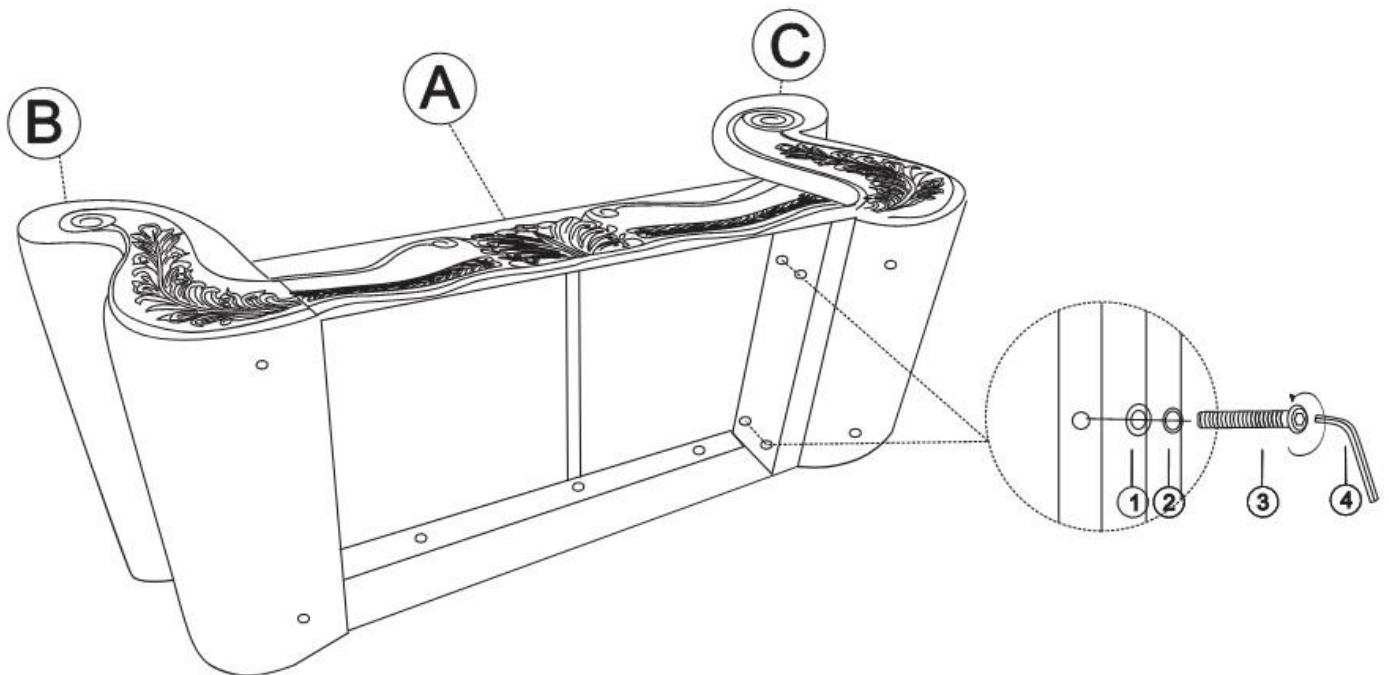

#### **STEP 2:**

Align and install the legs (F) to the bottom of the arms (B & C)

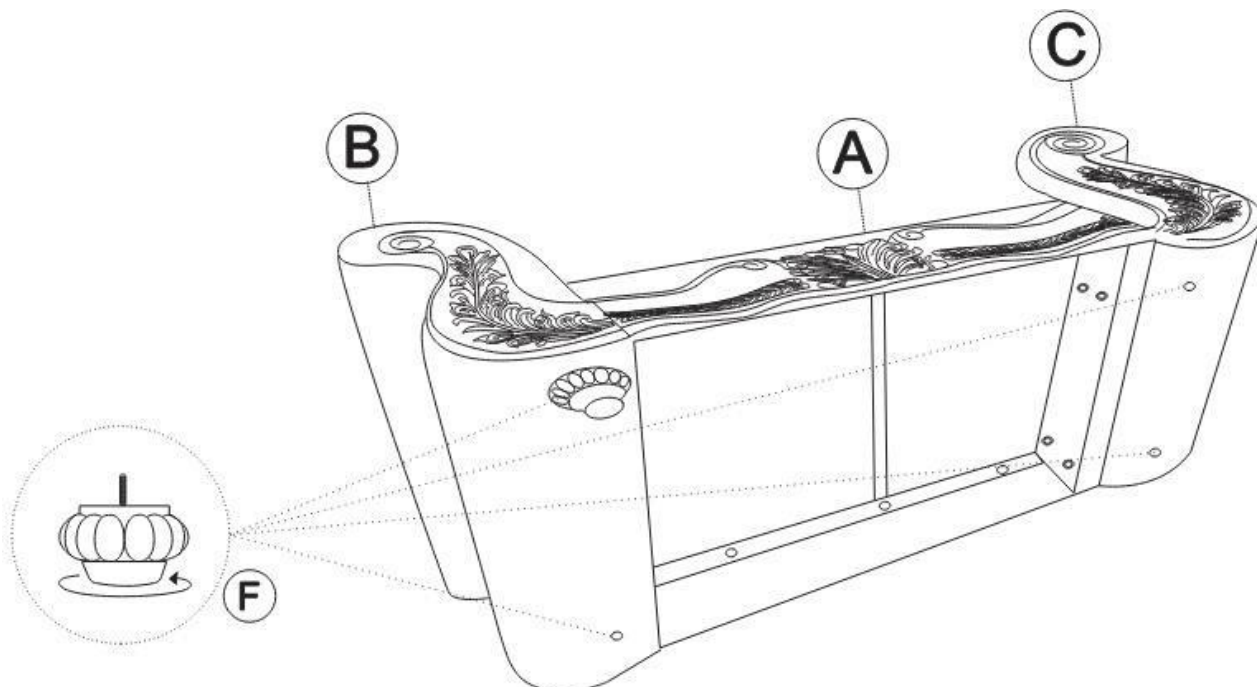

# ASSEMBLY INSTRUCTIONS FOR ACME FURNITURE

## MODEL#LV03831

- LV03831-1 MAXIMUS LOVESEAT – FRAME, CUSHION, ARMS,LEGS & 3 PILLOWS
- LV03831-2 MAXIMUS LOVESEAT – BACKREST

### **STEP 3:**

Place the frame up right and install the backrest (D) to the LSF arm (B) and RSF arm (C) by sliding the brackets all the way until it is secured.

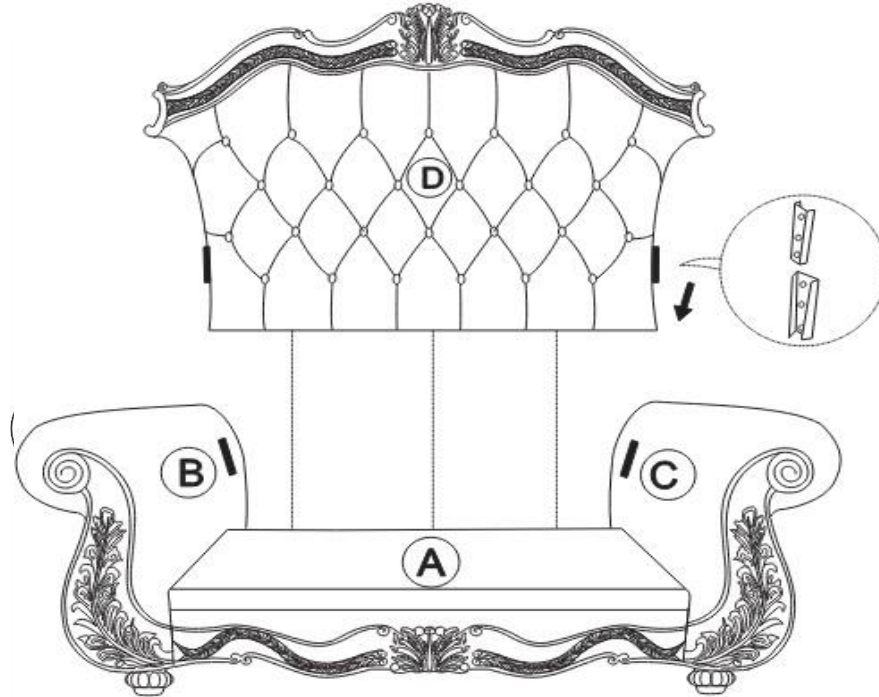

### **STEP 4:**

Place the chair on its back on a clean and soft surface and secure the bolts for the chair back (D) at bottom the seat frame (A) by using the Allen key (4) with hardware 1,2 and 5.

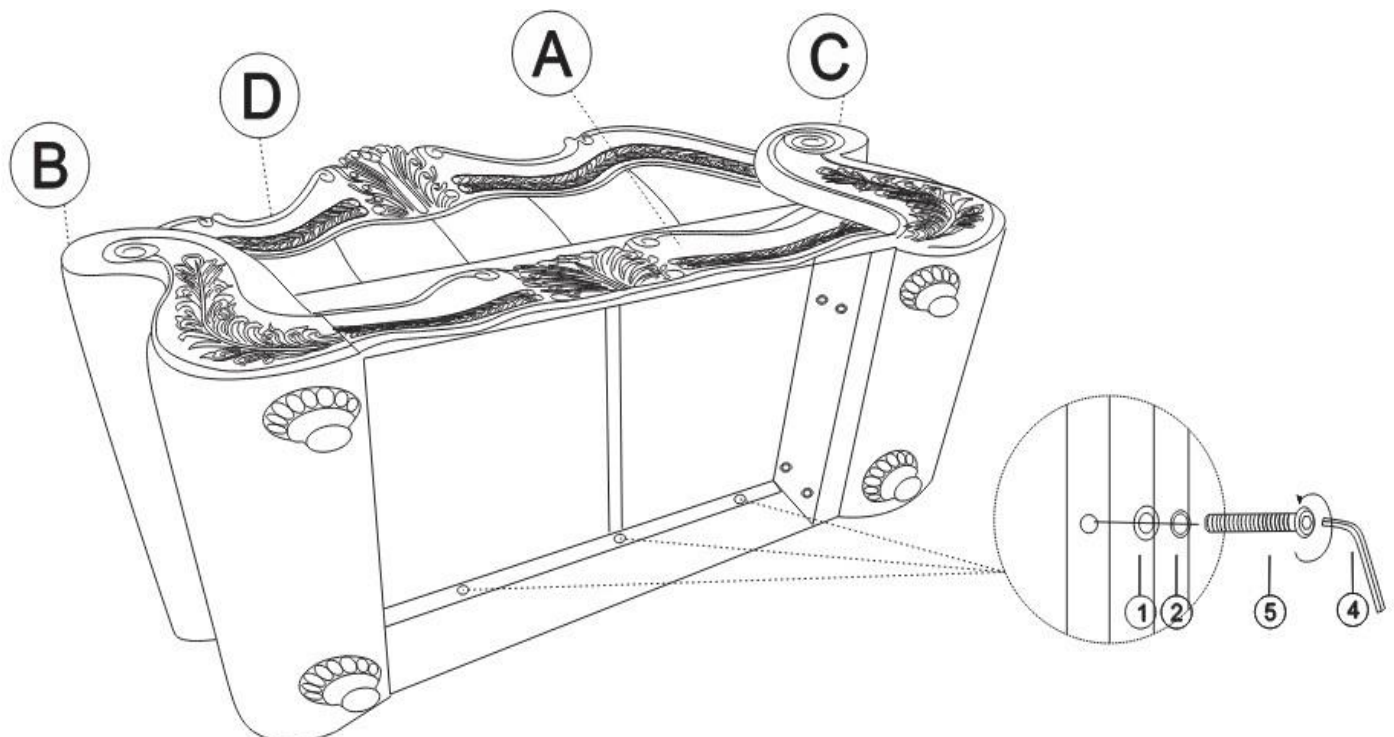

# ASSEMBLY INSTRUCTIONS FOR ACME FURNITURE

## MODEL#LV03831

- LV03831-1 MAXIMUS LOVESEAT – FRAME, CUSHION, ARMS,LEGS & 3 PILLOWS
- LV03831-2 MAXIMUS LOVESEAT – BACKREST

### **STEP 5:**

Place the frame up right and place the seat cushion (E) to the seat frame.

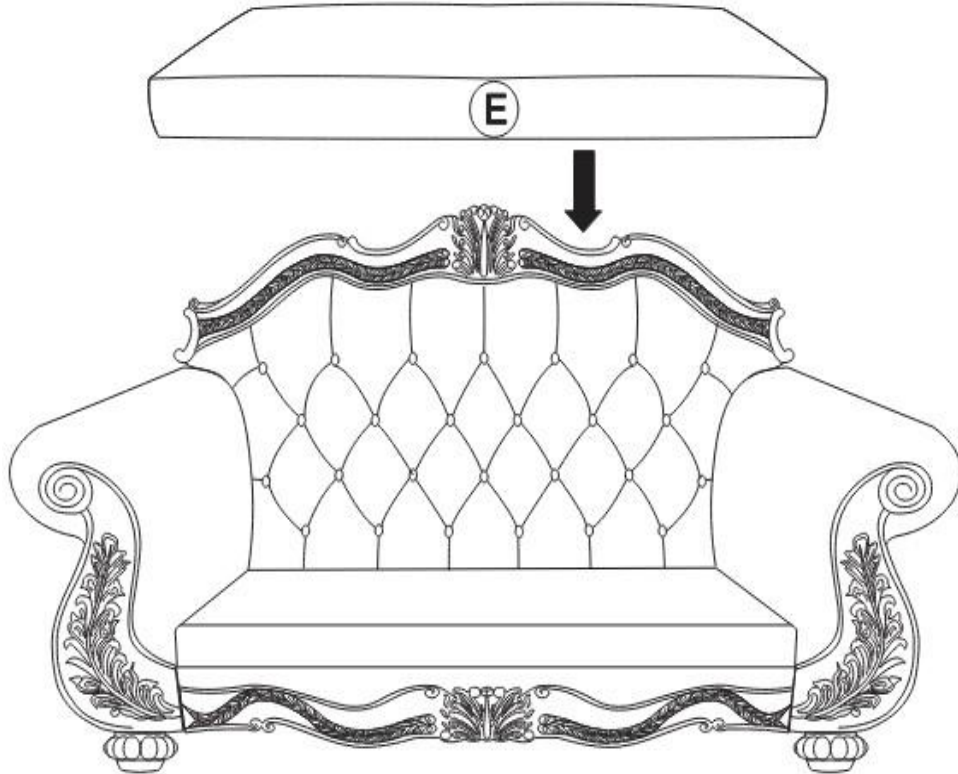

### **FINISH**

