

ASSEMBLY INSTRUCTIONS

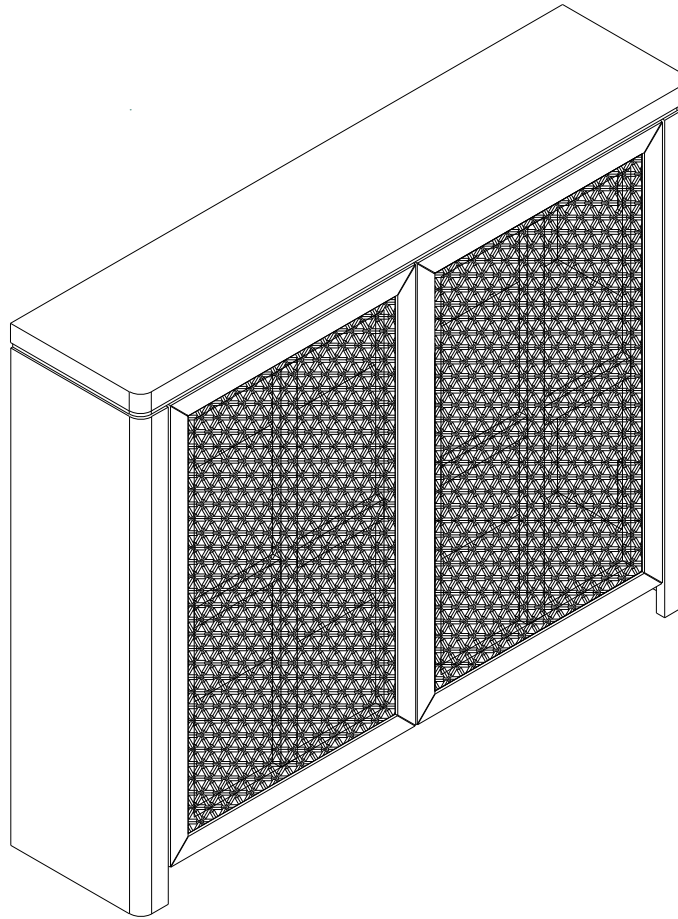

Notice:

1. Follow the installation instructions. Please confirm all accessories are preset before installation.
2. Do not fully tighten the screws during initial assembly. Fully tighten screws only once all pieces which are correctly assembled.
3. If you encounter any problems during installation, please contact our customer service.
4. Please unbox the item from the side with an open-label and put a carpet on the floor to avoid scratching it.

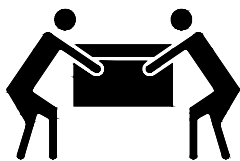

Recommended installers:2

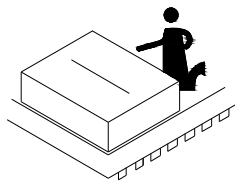

Put a carpet on the floor
before unpacking

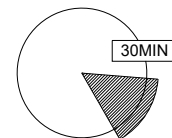

Estimate installation time:
30minutes





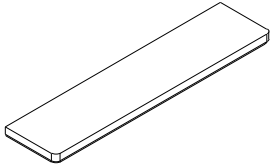
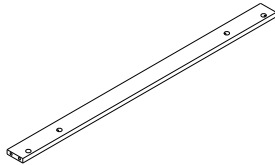
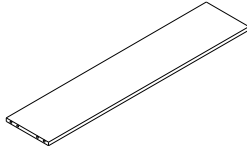
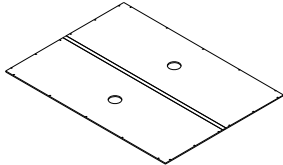
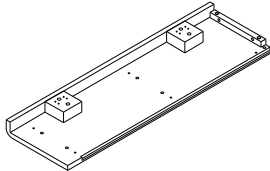
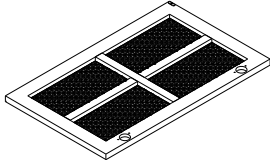
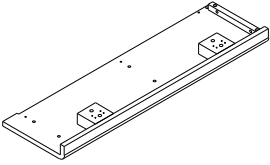
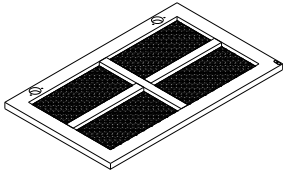

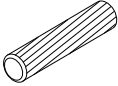

ASSEMBLY INSTRUCTIONS

PART LIST

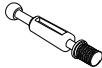
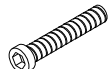
Item no.	Reference Image	Qty		Item no.	Reference Image	Qty
Ⓐ		X1		Ⓔ		X1
Ⓑ		X2		Ⓕ		X1
Ⓒ		X1		Ⓖ		X1
Ⓓ		X1		Ⓗ		X1

ASSEMBLY INSTRUCTIONS

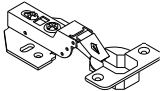
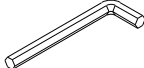
HARDWARE LIST

Item no.	Reference Image	Qty	Item no.	Reference Image	Qty
1	 Ø8*30mm	X15+1	7	 Ø3*15mm	X22+2
2		X12+1	8	 Ø1/4"*1/4"	X4
3		X12+1	9		X4
4	 Ø3*12mm	X24+2	10		X4
5		X4	11		X1
6		X2			

ASSEMBLY INSTRUCTIONS

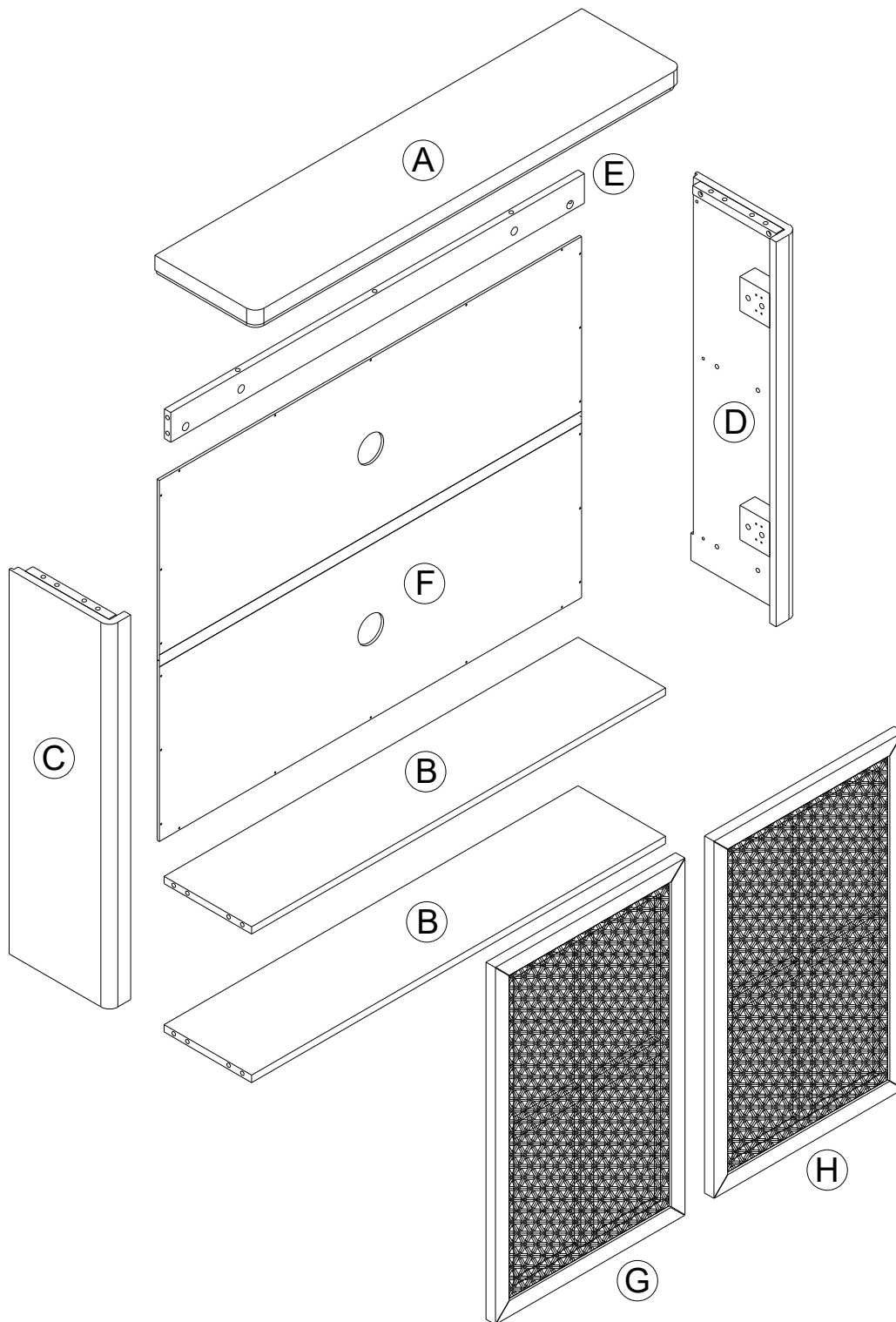

ASSEMBLY INSTRUCTIONS

1

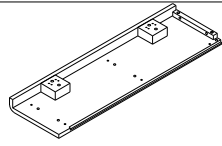

C 1PC

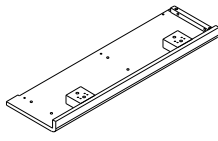

D 1PC

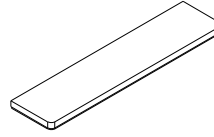

A 1PC



2 12PCS

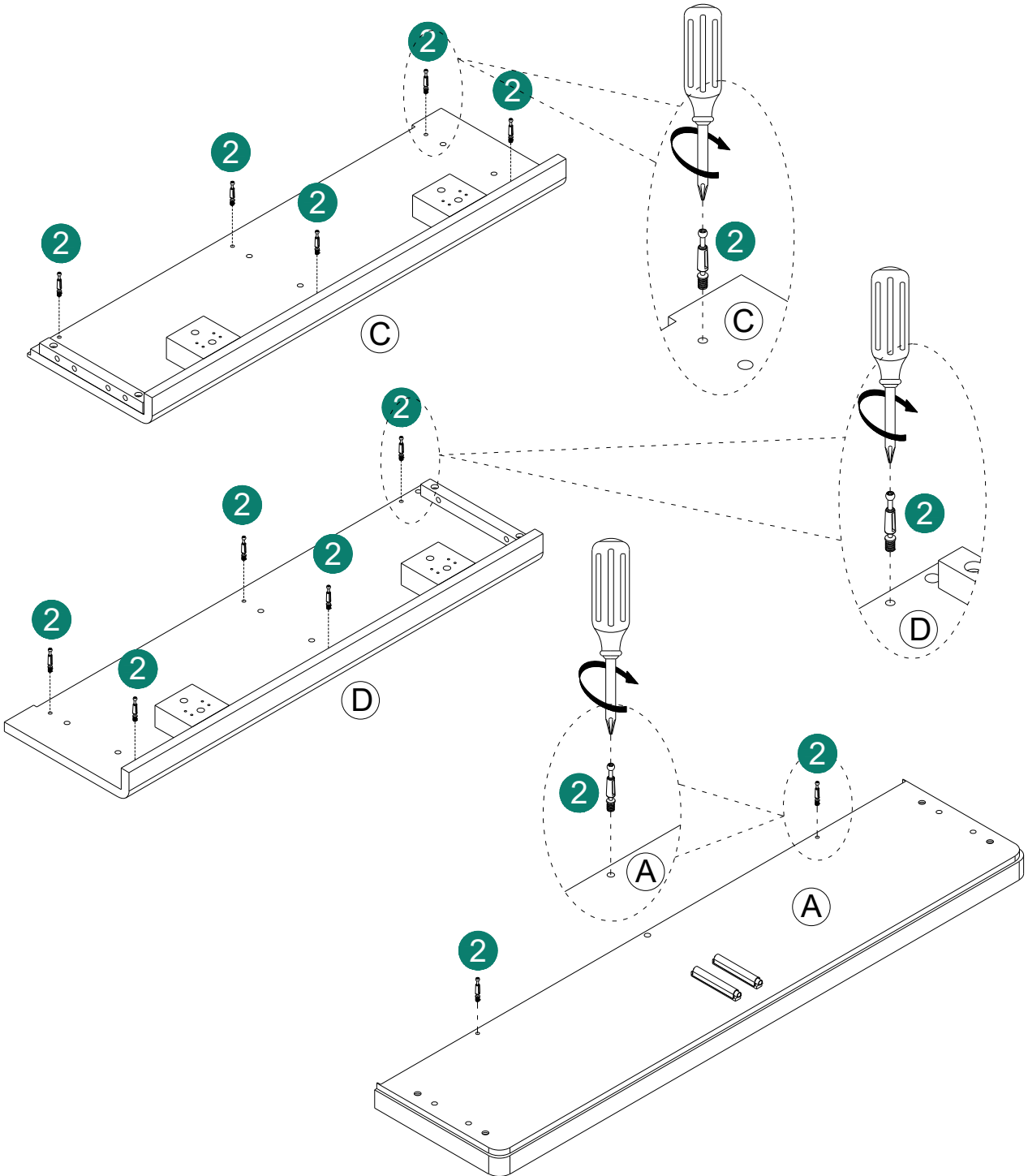

5

ASSEMBLY INSTRUCTIONS

3

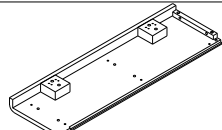

Ⓒ 1PC

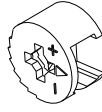

Ⓓ 5PCS

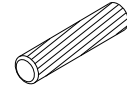

Ⓙ 5PCS

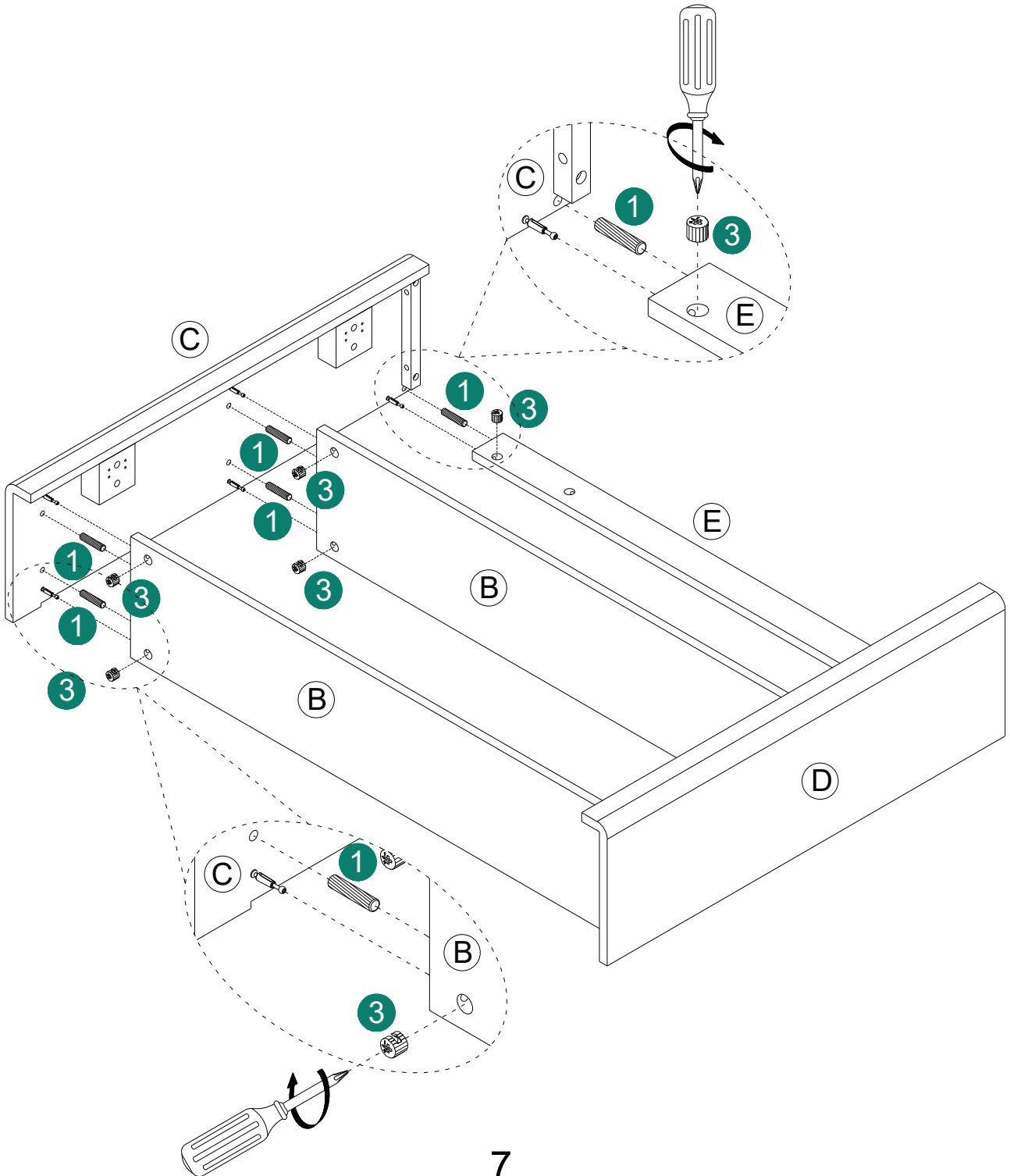

ASSEMBLY INSTRUCTIONS

4

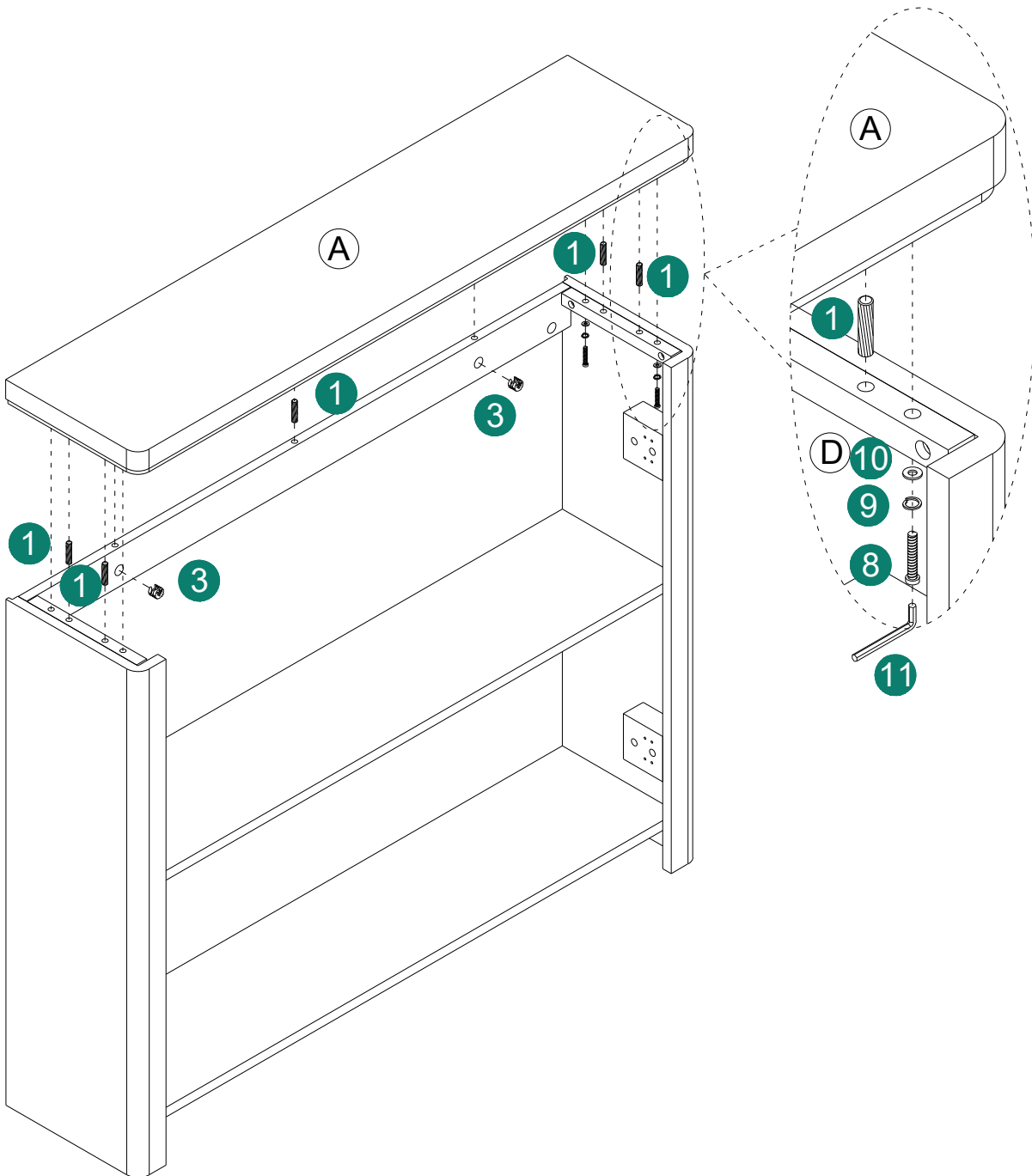
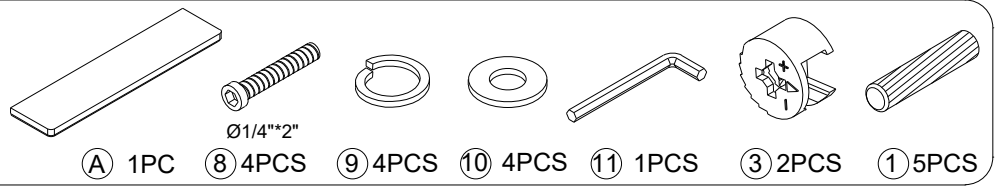

ASSEMBLY INSTRUCTIONS

5

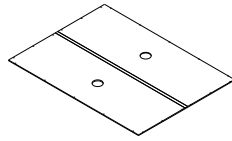

F 1PC

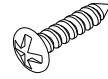

7 22PCS

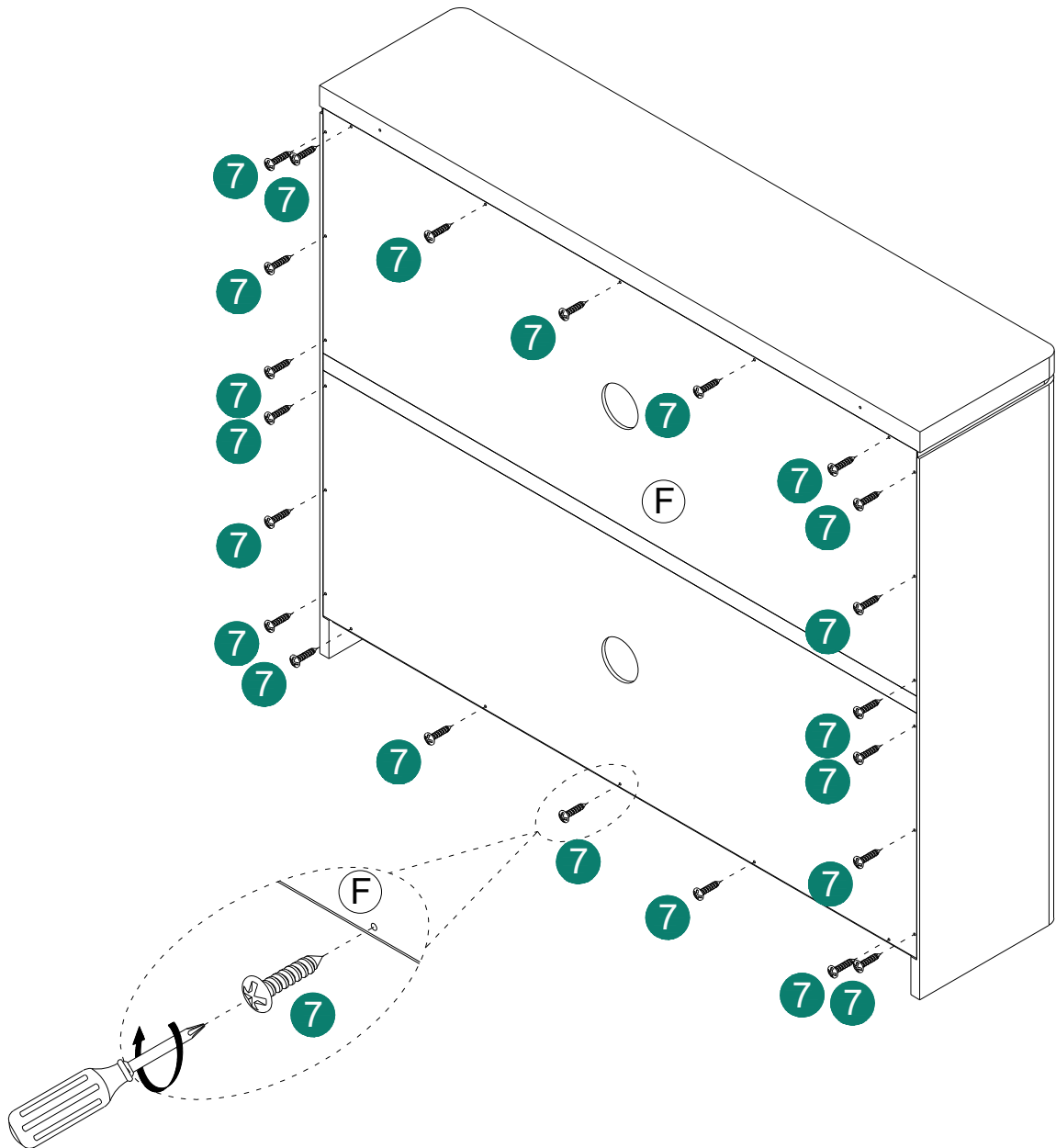

ASSEMBLY INSTRUCTIONS

6

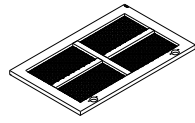

Ⓒ 1PC

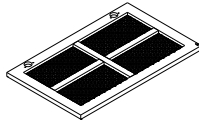

Ⓗ 1PC

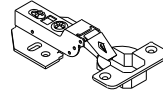

⑤ 4PCS

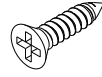

④ 8PCS

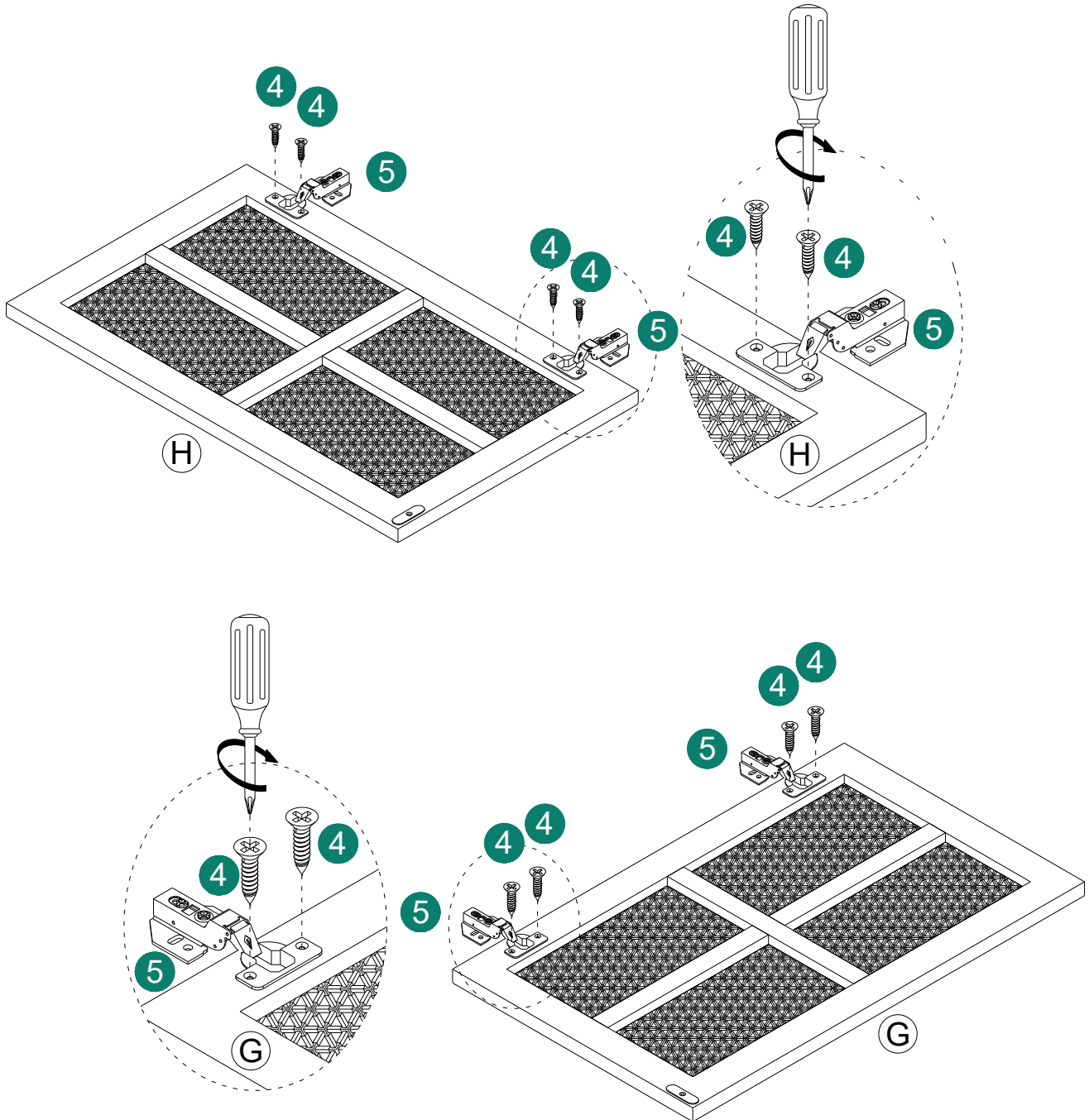

ASSEMBLY INSTRUCTIONS

7

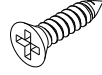

④ 16PCS

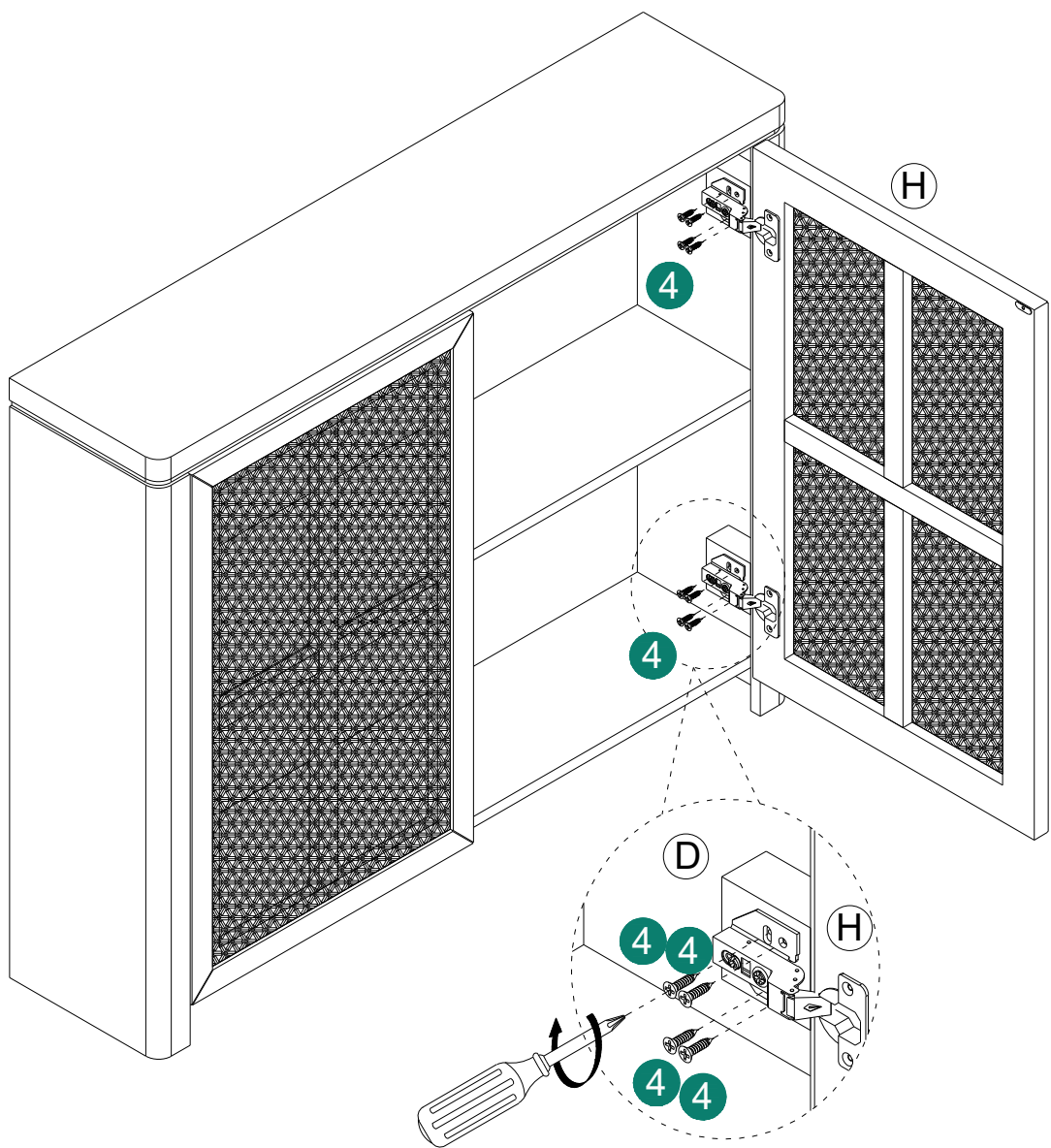

ASSEMBLY INSTRUCTIONS

8

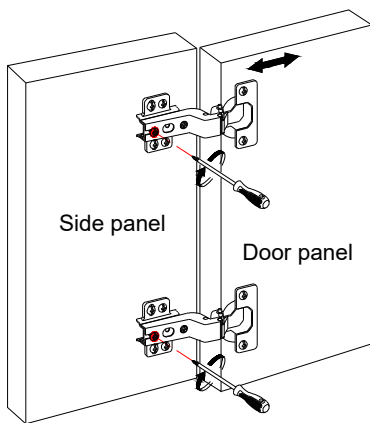

①

Front-to-Back Direction Adjustment:

Rotate the screws on the door hinges shown in the image. The door panel can be moved front-back.

Adjustment range: 4mm

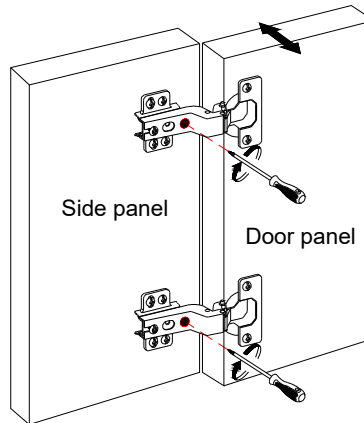

②

Left-Right Direction Adjustment:

Rotate the screws on the door hinges shown in the image. The door panel can be moved left-right.

Adjustment range: 3mm

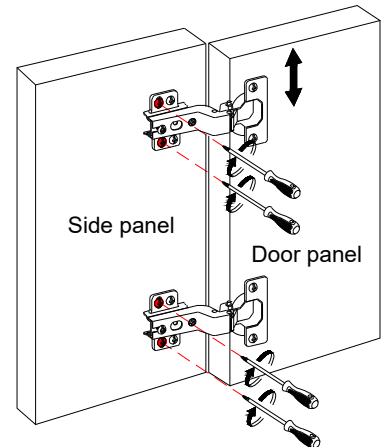

③

Up-Down Direction Adjustment:

Rotate the screws on the door hinges shown in the image. The door panel can be moved up-down.

Adjustment range: 4mm

ASSEMBLY INSTRUCTIONS

9

Common Door Panel Issues:

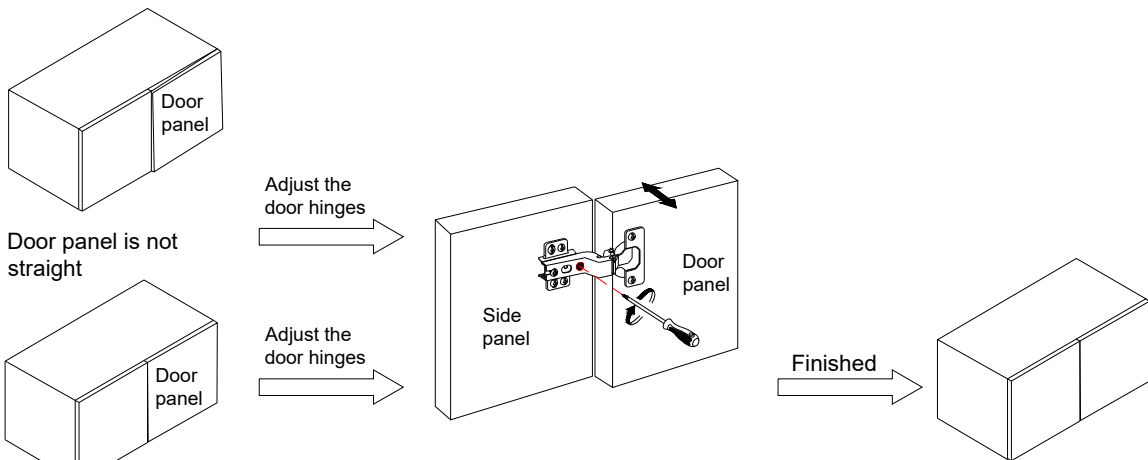

The gap between door panels is too large

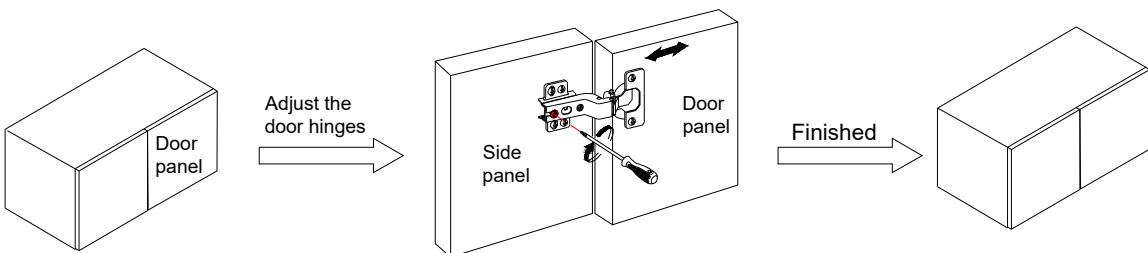

The door panels are not coplanar

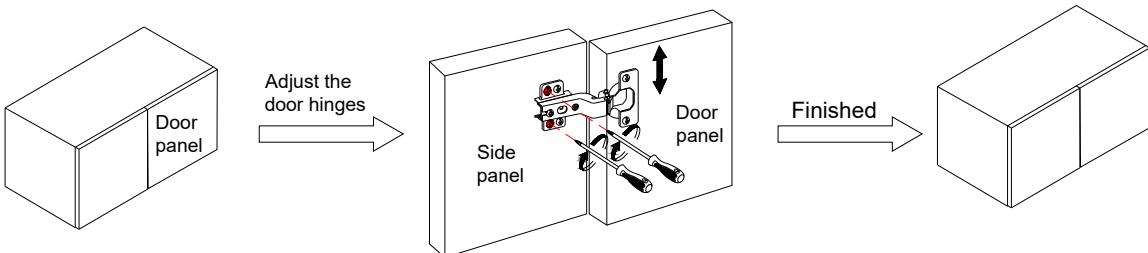



The two door panels are not at the same height

ASSEMBLY INSTRUCTIONS

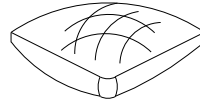
10

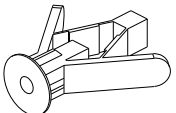

⑥ 2set

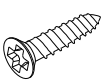
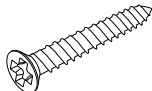
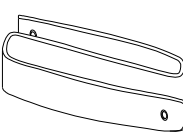
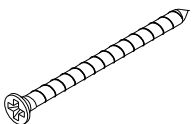
A	B	C	D	E	F
					
3pcs	5pcs	Ø8*3/4" 2pcs	Ø8*1-1/2" 2pcs	2pcs	Ø8*2" 1pcs

