

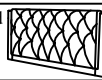

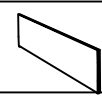









# ASSEMBLY INSTRUCTIONS

## EASTERN KING BED (4+8)

### (Box 1) BOX OF HEADBOARD & FOOTBOARD

No	ITEM	Qty
A	Headboard 	1 pc
B	Footboard 	1 pc
C	Headboard Leg 	2 pcs
D	Bed Slats 	4 pcs
E	Bed Slats Support 	8 pcs
F	Side Rail(A)-Left 	2 pcs
G	Side Rail(B)-Right 	2 pcs
H	Bed Side Rail Leg 	2 pcs

### (Box 1) HARDWARE LIST

No	ITEM	Qty
1	JCBC M6 x 35mm 	12 pcs
2	SPRING WASHER 1/4" Rbw 	12 pcs
3	Flat Washer 1/4"ID x 13mmOD Blk 	12 pcs
4	ALLEN KEY m4x65mm Blk 	1 pc
5	ALLEN KEY m5x65mm Blk 	1 pc
6	Flat Head Chipboard Screw m4x32mm Rbw 	16 pcs

**STEP 1.1 :** Attach Head Board Leg ( C ) to Head Board ( A ) as shown using JCBC BOLT( 1 )with Spring Washer ( 2), Flat washer ( 3)and securing with ALLEN KEY ( 4 ) .

**STEP 1.2 :** Fix the other holes with Csk Screw ( 6 ) as shown.

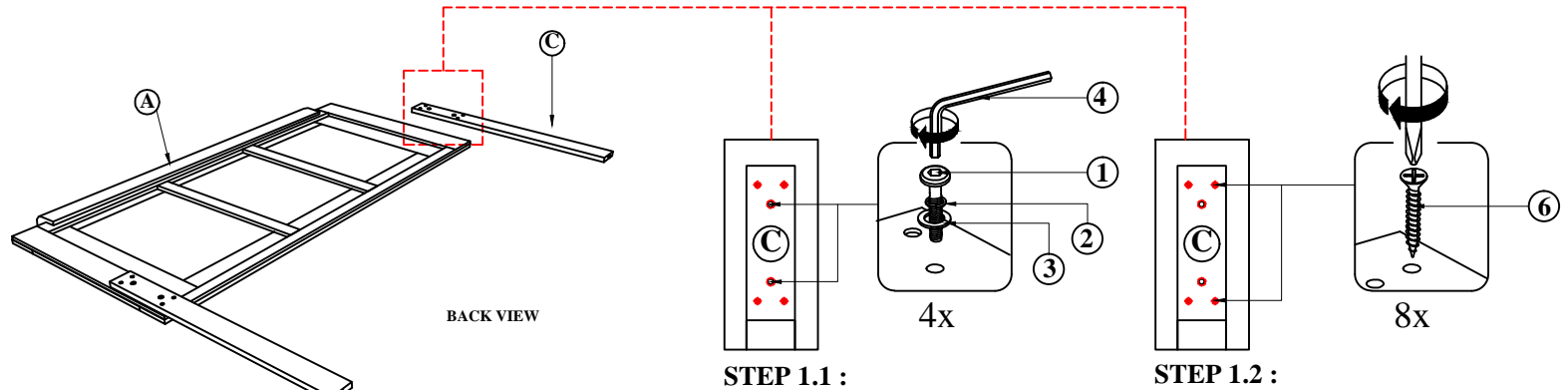

**STEP 2.1 :** Attach Side Rail ( F ) & ( G ) to the Bed Side Rail Leg ( H ) as shown using JCBC BOLT( 1 )with Spring Washer ( 2), Flat washer ( 3)and securing with ALLEN KEY ( 4 ) by outside side rail ( F ) & ( G ) .

**STEP 2.2 :** Hook SET-UPSIDE RAIL TO HEAD BOARD ( A ) closely and push down to fit. repeat step 2 with other end of rail to hook onto FOOTBOARD ( B ).

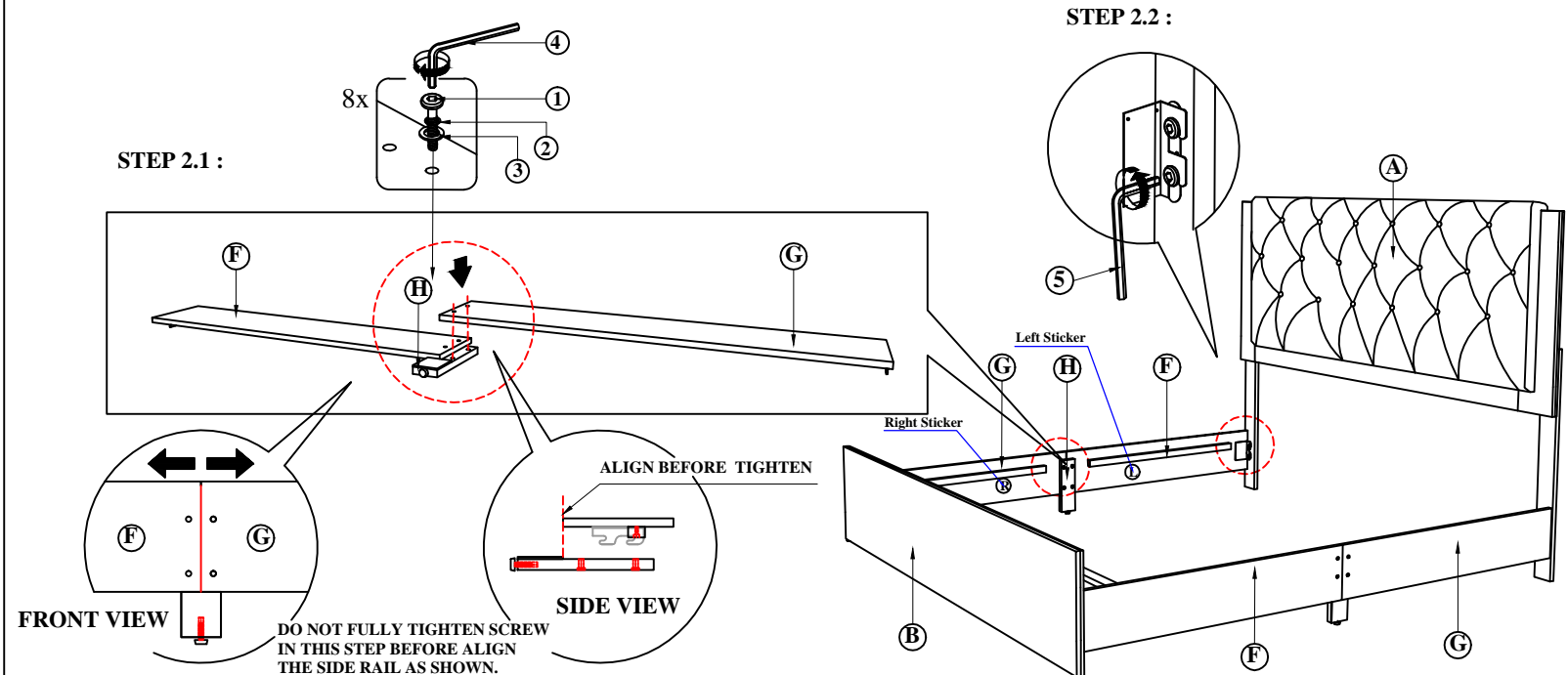

# ASSEMBLY INSTRUCTIONS

**STEP 3 :** Tighten the 4 Corner with Allen Key (5). Fix the Bed Slat Support Leg (E), to Bed Slat (D) as shown. Install the bed slat (D) to side rail (F) & (G) and tighten with Csk Screw (6) as per diagram shown. (NOTE: THE SETUP MUST BE DONE AT THE DECIDED LOCATION FOR THE BED TO OBTAIN PERFECT STABILITY)

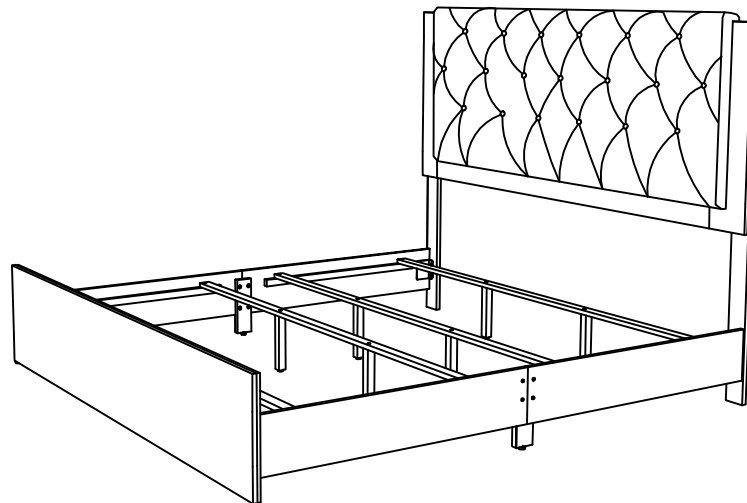
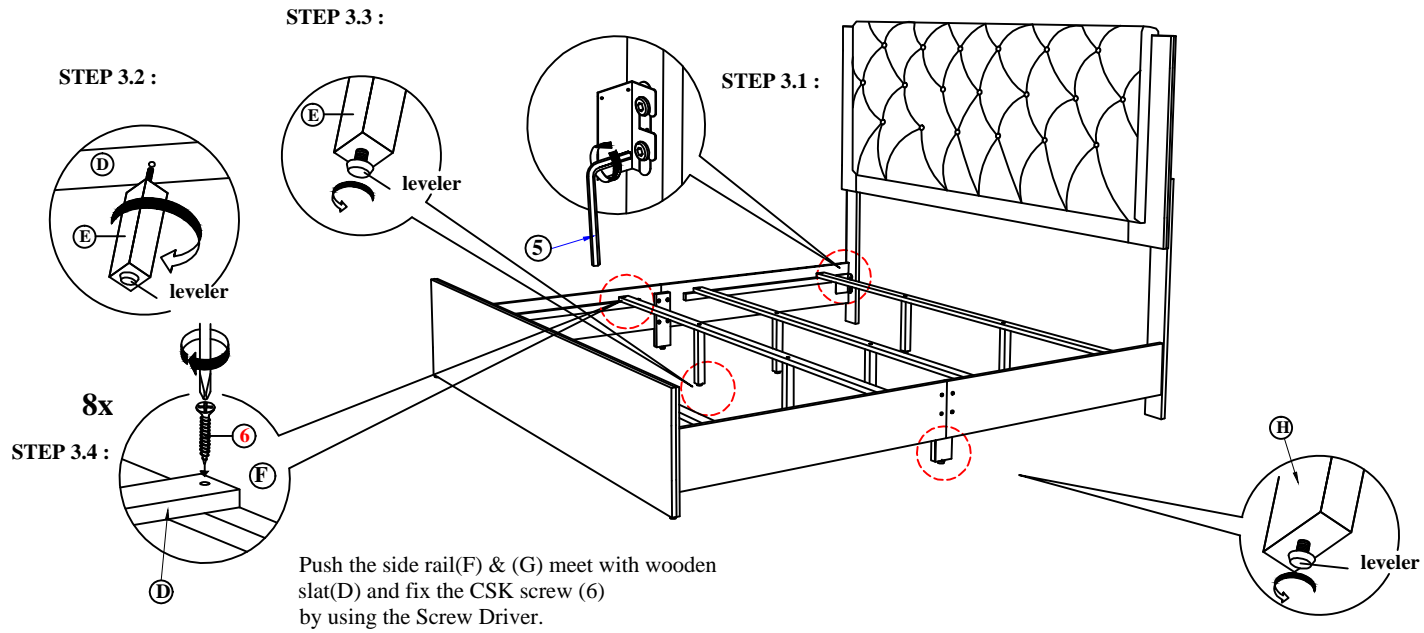

COMPLETE ASSEMBLY