

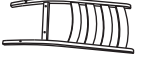

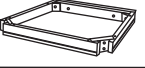











# Assembly Instruction

## LADDERBACK SIDE CHAIR

NO	Parts List		Q'TY
A		Chair Back	1
B		Box Seat	1
C		Hardseat	1
D		Left Front Leg	1
E		Right Front Leg	1
F		Left Side Stretcher	1
G		Righth Side Stretcher	1

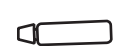
NO	Hardware List		Q'TY
1		8 x 1" Wood Screw	6
2		8 x 1.1/4" Pan Head Screw	4
3		M6x 40mm JCBC Bolt	2
4		M6x70mm JCBC Bolt	6
5		M6x13mm Lock Washer	8
6		M6.5x16.5mm Flat Washer	8
7		M4 x 2.1/2" Allen Key	1
8		Assembly Glue	1

**Important Note**  
Do not use power tool for assembly.  
All bolt must fasten either by wrench or Allen Key.



**STEP 2** Do not fully tighten the bolt

**STEP 1** Do not fully tighten the bolt

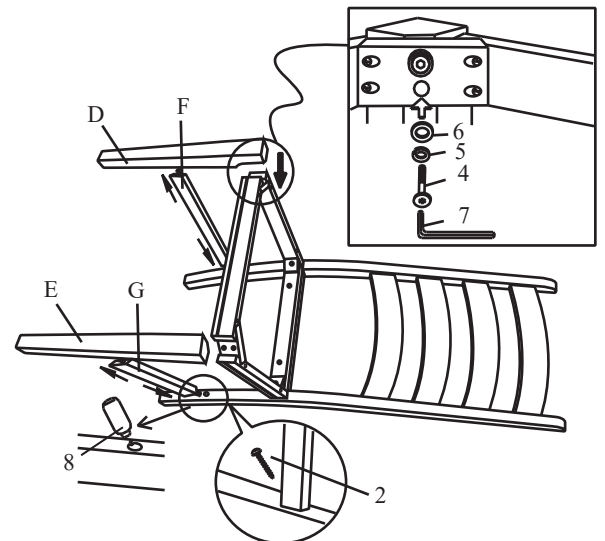
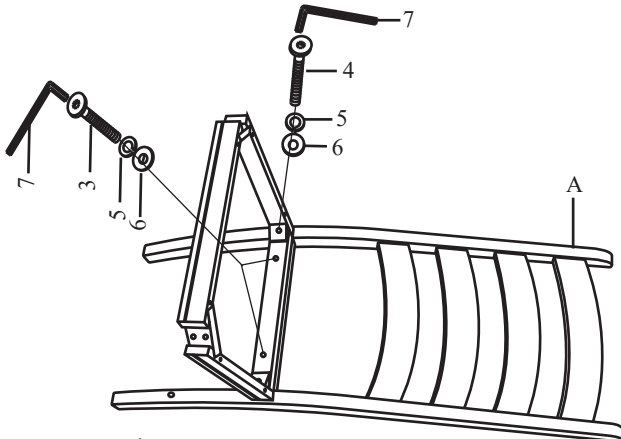

**STEP 4**

Levelling solution: Loosen each bolt in the seat box (front legs, back corner blocks and back apron) to the point where it can be turned with our fingers. Place the Chair/Stool upright on the floor and make sure Chair/Stool back and seat frame are well connected. Sit in the Chair/Stool, but do not lean against the Chair/Stool back. Gently sway back and forth, left and right. Carefully turn the Chair/Stool upside down, and tighten each bolt. The Chair/Stool will now be levelled.

