

Owner Manual

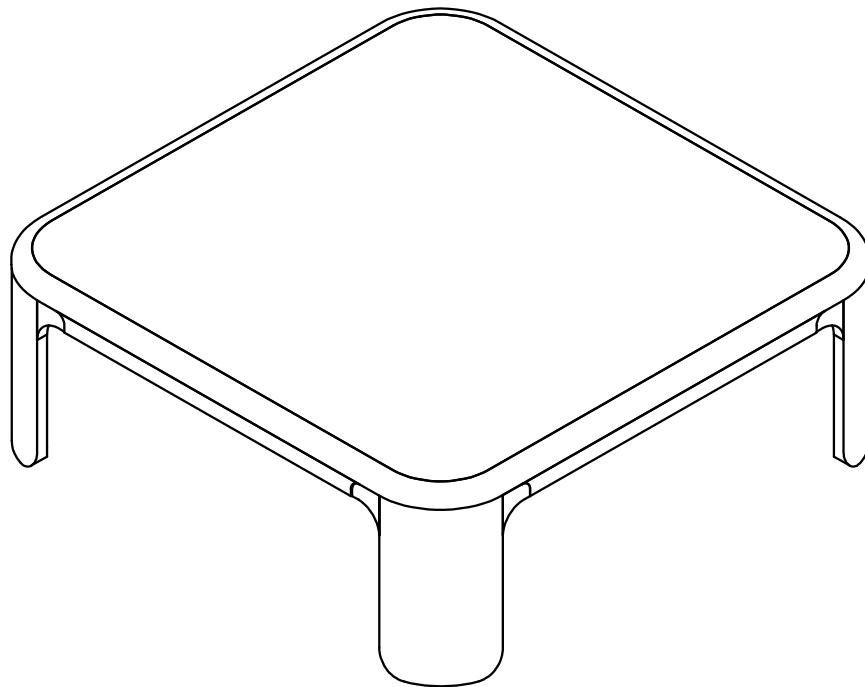

Weight Limitation
200 LBS



Installation:
10 minutes.



Two Person

MAINTENANCE AND WARNINGS



Before You Start

Please follow the steps below:



- ⚠ Check the packaging for any damage, deformation, or water stains. If there is significant damage, please contact us promptly.
- ⚠ Unpack the box and compare the contents with the parts list and hardware list to ensure all components and accessories are present and complete.
- ⚠ Please read the installation instructions carefully to understand the installation steps and precautions to ensure proper installation.
- ⚠ Clean the installation area in advance and ensure the ground is level and there is enough space to avoid damaging the furniture or making installation difficult.
- ⚠ Lay a protective mat on the ground to prevent scratching the floor during installation.

After-Sales Service

- If you encounter any issues or need technical support during use, please contact our after-sales team. We offer long-term maintenance and warranty services.





Precautions

-  This product is for indoor use only. Do not expose it to outdoor elements or high-humidity environments.
-  Keep the product away from high heat or open flames to prevent fire hazards.
-  Do not allow children to climb on the product, as this may cause tipping and result in personal injury.



Safety Warnings

-  If you notice any loose or damaged parts, stop using the product immediately and contact customer service.
-  Do not attempt to disassemble or replace any components yourself, as this may affect the stability and safety of the product.

Daily Maintenance

- Regularly clean the surface with a soft cloth to prevent dust accumulation.
- Do not use cleaning agents containing acids, alkalis, or corrosive substances, as they may damage the surface. It is recommended to use neutral cleaning agents or specialized furniture cleaners.
- Avoid exposing furniture to humid environments for extended periods. Use a dehumidifier or desiccant during humid weather.
- Avoid direct contact of furniture with water. If water is accidentally spilled, wipe it dry immediately.
- Avoid placing excessively heavy objects on the furniture: ensure the weight is within a reasonable load-bearing range.
- Avoid using sharp or rough items on the furniture surface to prevent scratches. Handle items gently when moving them.

Explosive view

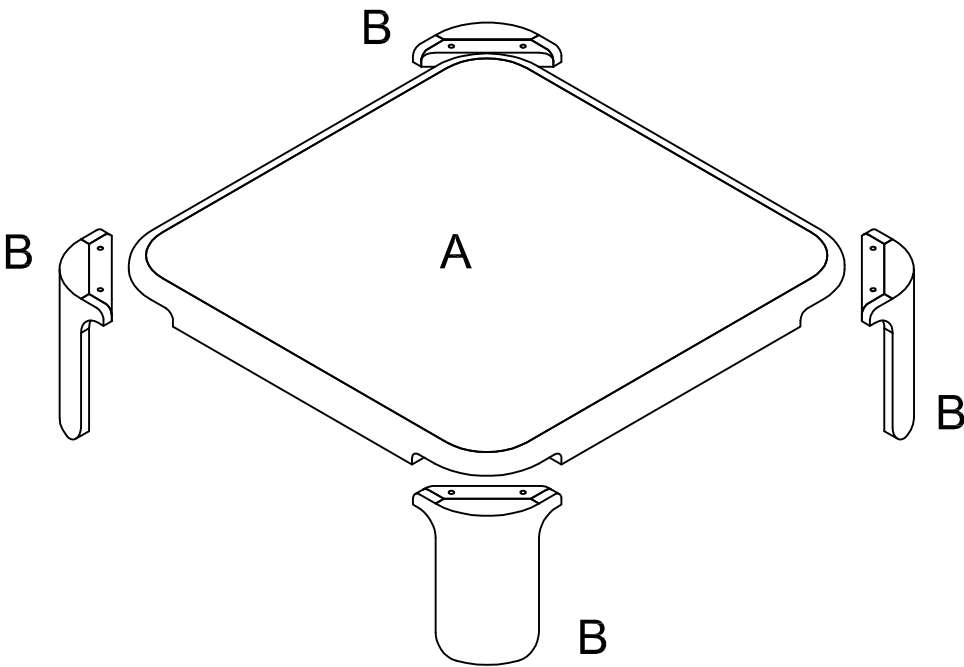

Parts list

A x1 Table Top

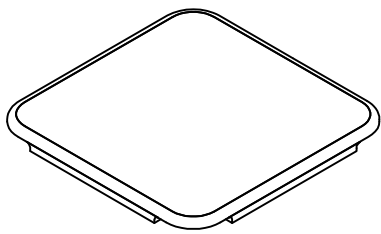

B x 4 Leg

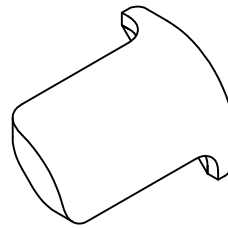

Hardware List

①x8+1 Bolt

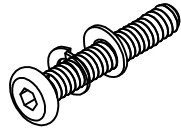

D5\16"x 2 "

②x1 Allen Key

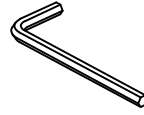

M4





Note: Before installing the screws, please first distinguish the length of the screw rods.

Step 1

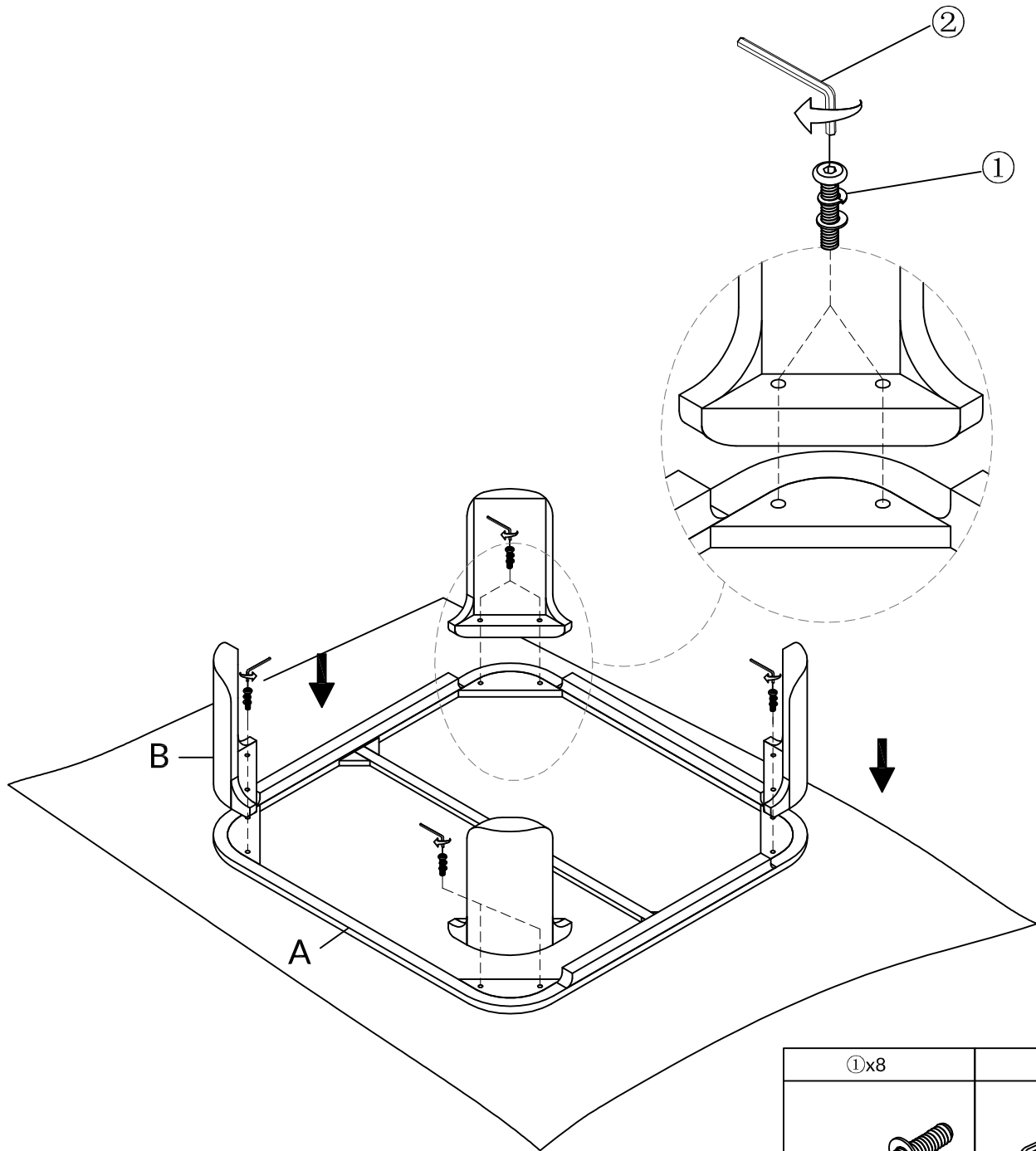
Attach leg B to top table A using Bolt ① tight it with Allen wrench②.
Alignment leg with apron when assembly Legs .
Do not tighten all the Bolts until complete.

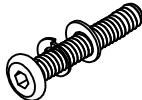

①x8	②x1
	
D5\16"x 2 "	M4

WARRANTY

- We strive to offer quality products, and we also try our best to satisfy every customer who orders from us with products or services as needed.
- Replacement parts can be purchased from our company if available.
- For returns, please check the return policy with the retailer or marketplace where you purchased the item.